

ROME-4 PLANAR SVT-R

	DATE	EC NO.	PART NO.
REL	DEC/07/04	J79495	39T0167
			DEVELOPMENT NO.
			Q/M
			1 /88

VER 0.91
DEC/07/2004

- | | |
|--------------------------------------|-----------------------------------------|
| 1. TITLE PAGE | 45. CDC CONNECTOR |
| 2. EC HISTORY | 46. CARDBUS CONTROLLER(1/2) |
| 3. CPU(1/3) | 47. CARDBUS CONTROLLER(2/2) |
| 4. CPU(2/3) | 48. CARDBUS/EXC SLOT |
| 5. CPU(3/3) | 49. CARDBUS/EXC PWR CTRL |
| 6. ITP CON/LARGE PTH HOLE/EMI FINGER | 50. < BLANK PAGE > |
| 7. VCCCPUCORE DECOUPLING | 51. GBE BCM5751M(1/2) |
| 8. ALVISO(1/7) : HOST I/F | 52. GBE BCM5751M(2/2) |
| 9. ALVISO(2/7) : DDR2-A | 53. GBE MAGNETICS |
| 10. ALVISO(3/7) : DDR2-B | 54. RJ11/RJ45 CONNECTOR |
| 11. ALVISO(4/7) : PEG/DMI | 55. MINI PCI SLOT |
| 12. ALVISO(5/7) : GRAPHICS | 56. PCI BUS SWITCH |
| 13. ALVISO(6/7) : VCC/GND | 57. DOCKING CONNECTOR |
| 14. ALVISO(7/7) : VCC/GND(NTCF) | 58. H8S/2161B |
| 15. DDR2 SODIMM-A | 59. KEYBOARD CONNECTOR |
| 16. DDR2 SODIMM-B | 60. TOUCH PAD CONNECTOR |
| 17. DDR2 TERMINATION | 61. MISC G/A (PMH6) |
| 18. DDR2 DECOUPLING | 62. IO KEEPER(SUPER I/O, TPM, RFTD) |
| 19. CLOCK GEN(CK410M) | 63. PARALLEL INTERFACE |
| 20. ATI M24(1/6) : PEG I/F | 64. SERIAL INTERFACE |
| 21. ATI M24(2/6) : LVDS/CRT/TV/TMDS | 65. IR MODULE |
| 22. ATI M24(3/6) : CLK/GPIO | 66. THERMAL SENSOR |
| 23. ATI M24(4/6) : ANALOG POWER | 67. I2CBUS/SMBUS |
| 24. ATI M24(5/6) : VCC | 68. FAN CONTROL |
| 25. ATI M24(6/6) : GND | 69. G-SENSOR |
| 26. LCD CONNECTOR | 70. EMC DECOUPLING |
| 27. EXT CRT INTERFACE | 71. RGB SWITCH |
| 28. TV_OUT | 72. DC-IN AND CHARGER (ADP3806) |
| 29. ICH6-M(1/4) : DMI/PCI/LPC/AC97 | 73. CHARGE SELECTOR |
| 30. ICH6-M(2/4) : ATA/USB/PM | 74. BATTERY INPUT |
| 31. ICH6-M(3/4) : PCI EXPRESS | 75. BATTERY MONITOR |
| 32. ICH6-M(4/4) : VCC/GND | 76. POWER SEQUENCE |
| 33. FWH,RTC BATTERY | 77. DC-DC VCC3M/VCC5M (MAX1901ETJ) |
| 34. SATA BRIDGE/HDD CONN | 78. DC-DC VCCCPUCORE (ADP3205) |
| 35. BAY I/F CONN | 79. DC-DC VCORE INPUT CAP |
| 36. USB POWER/CONN | 80. DC-DC VCC1R8M (MAX1993ETG) |
| 37. AUDIO AD1981B | 81. DC-DC VCC1R5M/VCC1R05B (MAX1540ETJ) |
| 38. AUDIO MISC | 82. DC-DC VCCVIDEOCORE (MAX1993ETG) |
| 39. AUDIO INT MIC | 83. DC-DC VCC2R5M/VCC0R9B |
| 40. AUDIO HP & EXT MIC CONN | 84. TSURUMAI-2 |
| 41. AUDIO EXT MIC AMP | 85. LOAD SW 1 (VIDEO) |
| 42. AUDIO SPEAKER | 86. LOAD SW 2 (AUX) |
| 43. AUDIO HDP AMP AN12943A(1/2) | 87. LOAD SW 3 (B,UBAY) |
| 44. AUDIO HDP AMP AN12943A(2/2) | 88. MAX POWER CTRL |

39T0167

DESIGNER	Y.I	DEC/07/04	PART NO.	IBM
CHECKED	Y.Y	DEC/07/04	39T0167	
APPROVED	T.S	DEC/07/04	TITLE ROME-4 SVT-R(V0.91)	
CLASS	T.S	DEC/07/04	TITLE PAGE	
THIS DOCUMENT IS THE PROPERTY OF IBM ITS USE IS AUTHORIZED ONLY FOR RESPONDING TO A REQUEST FOR QUOTATION OR FOR THE PERFORMANCE OF WORK FOR IBM. ALL QUESTIONS MUST BE REFERRED TO THE IBM PURCHASING DEPARTMENT.				IBM CONFIDENTIAL

EC HISTORY

	DATE	EC NO.	PART NO.
REL	DEC/07/04	J79495	39T0167
			DEVELOPMENT NO.
			Q/M
			2 /88

PRE-DV

PRE-DV GERBER RELEASED 12/17/2003

VER.0.32 01/07/2004 RM4_SDV_EC_126 AND CHANGE R130 TO 150.

SDV

VER.0.33 01/07/2004 RM4_SDV_EC_127
 VER.0.34 01/16/2004 RM4_SDV_EC_128/129/130/131
 VER.0.35 01/20/2004 RM4_SDV_EC_133/135
 VER.0.36 01/23/2004 RM4_SDV_EC_137
 VER.0.37 01/27/2004 RM4_SDV_EC_138 TO 141
 VER.0.38 02/03/2004 RM4_SDV_EC_142--148
 VER.0.39 02/04/2004 RM4_SDV_EC_149/150/151/152
 VER.0.40 02/06/2004 RM4_SDV_EC_153/154/155/156/157
 VER.0.41 02/12/2004 RM4_SDV_EC_158/159/160/161/162
 VER.0.42 02/16/2004 RM4_SDV_EC_163

SDV GERBER RELEASED 02/17/2004

VER.0.43 02/18/2004 RM4_SDV_EC_164/165/166

SIV

VER.0.44 03/26/2004 RM4_SIV_EC_001/002
 VER.0.45 04/01/2004 RM4_SIV_EC_003 TO 008 AND 012
 VER.0.46 04/05/2004 RM4_SIV_EC_09/10/14/19/20/21/22/23/24
 VER.0.47 04/07/2004 CORRECT R872 TO NO-ASMRM AND J31 CRT CONN WIRING.
 VER.0.48 04/08/2004 RM4_SIV_EC_027/28/30/31/34/35
 VER.0.49 04/11/2004 RM4_SIV_EC_35 CORRECTION (R41->ASM) AND
 AND ADD EZJ1V270GA X7 (ESD REASON).

SIV GERBER RELEASED 04/13/2004

VER.0.50 04/16/2004 RM4_SIV_EC_32/33/36/37/38
 AND CORRECT C1000 TO SYMBOL WITH POLARITY.
 VER.0.51 04/20/2004 CORRECT R417 TO 0 , R522 TO 2M.
 VER.0.52 04/21/2004 RM4_SIV_EC_39/40/41
 VER.0.53 04/22/2004 RM4_SIV_EC_42/43
 VER.0.54 04/23/2004 RM4_SIV_EC_44

PRE-SIT

VER.0.55 05/18/2004 RM4_SIT_EC_01/02/03/04
 VER.0.56 05/21/2004 RM4_SIT_EC_05/07/09/13/14/15
 VER.0.57 05/25/2004 RM4_SIT_EC_16/17/18
 VER.0.58 05/26/2004 RM4_SIT_EC_ LINKUP/ACTIVITY CHNAGE
 VER.0.59 06/01/2004 RM4_SIT_EC_19
 VER.0.60 06/02/2004 RM4_SIT_EC_20/21/23/24/25
 VER.0.61 06/03/2004 RM4_SIT_EC_26
 VER.0.62 06/04/2004 RM4_SIT_EC_27/28/29
 VER.0.63 06/07/2004 RM4_SIT_EC_23/27 CORRECTION/30
 VER.0.64 06/11/2004 RM4_SIT_EC_32

PRE-SIT GERBER RELEASED ON 06/16/2004

VER.0.65 06/21/2004 RM4_SIT_EC_34
 VER.0.66 06/30/2004 RM4_SIT_EC_35 (R919 -> NO-ASM, R920->ASM)

PRE-SIT (CONTINUE)

VER.0.67 07/07/2004 RM4_SIT_EC_36 CHNAGED 12 PARTS
 VER.0.68 07/20/2004 RM4_SIT_EC_37/38/39/40

SIT

VER.0.69 07/28/2004 RM4_SITA_EC_02/03/06
 VER.0.70 07/29/2004 RM4_SITA_EC_07/08
 VER.0.71 08/03/2004 RM4_SITA_EC_09/10/11
 VER.0.72 08/06/2004 RM4_SITA_EC_12/13/14/15
 VER.0.73 08/16/2004 RM4_SITA_EC_16/17/18
 VER.0.74 08/17/2004 RM4_SITA_EC_19/20/21/22
 VER.0.75 08/18/2004 RM4_SITA_EC_23
 VER.0.76 08/20/2004 RM4_SITA_EC_26
 VER.0.77 08/23/2004 RM4_SITA_EC_27

SIT GERBER RELEASED 08/24/2004.

VER.0.78 08/30/2004 P51 TABLE CORRECTION
 VER.0.79 09/01/2004 RM4_SITA_EC_28
 VER.0.80 09/10/2004 RM4_SITA_EC_29/30

SIT-R

VER.0.81 10/05/2004 RM4_SITR_EC_01/02
 VER.0.82 10/08/2004 RM4_SITR_EC_03/04
 VER.0.83 10/19/2004 RM4_SITR_EC_05/06
 VER.0.84 10/22/2004 RM4_SITR_EC_07/08/10/11
 VER.0.85 10/25/2004 RM4_SITR_EC_12
 SIT-R GERBER WAS RELEASED 10/28/2004.
 VER.0.86 10/29/2004 RM4_SITR_EC_13
 VER.0.87 11/04/2004 RM4_SITR_EC_15
 VER.0.88 11/08/2004 RM4_SITR_EC_16/17

SVT

VER.0.89 11/09/2004 RM4_SVT_EC_01/02/03

SVT GERBER WAS RELEASED 11/12/2004.

VER.0.90 11/15/2004 RM4_SVT_EC_04/05
 VER.0.90 11/17/2004 ASSIGNED DWG PN=39T0120.

SVT-R

VER.0.91 11/26/2004 RM4_SVTR_EC_01/02.
 SVT-R GERBER WAS RELEASED 11/30/2004.
 VER.0.91 12/07/2004 ASSIGNED DWG PN=39T0167.

39T0167

DESIGNER	Y.I	DEC/07/04	PART NO.	IBM
CHECKED	Y.Y	DEC/07/04	39T0167	
APPROVED	T.S	DEC/07/04	TITLE ROME-4 SVT-R(V0.91)	
CLASS	T.S	DEC/07/04	HISTORY	
THIS DOCUMENT IS THE PROPERTY OF IBM. ITS USE IS AUTHORIZED ONLY FOR RESPONDING TO A REQUEST FOR QUOTATION OR FOR THE PERFORMANCE OF WORK FOR IBM. ALL QUESTIONS MUST BE REFERRED TO THE IBM PURCHASING DEPARTMENT.				IBM CONFIDENTIAL

REL	DATE	EC NO.	PART NO.
	DEC/07/04	J79495	39T0167
			DEVELOPMENT NO.
			Q/M
			3 / 88

U58

DOTHAN(1/3)

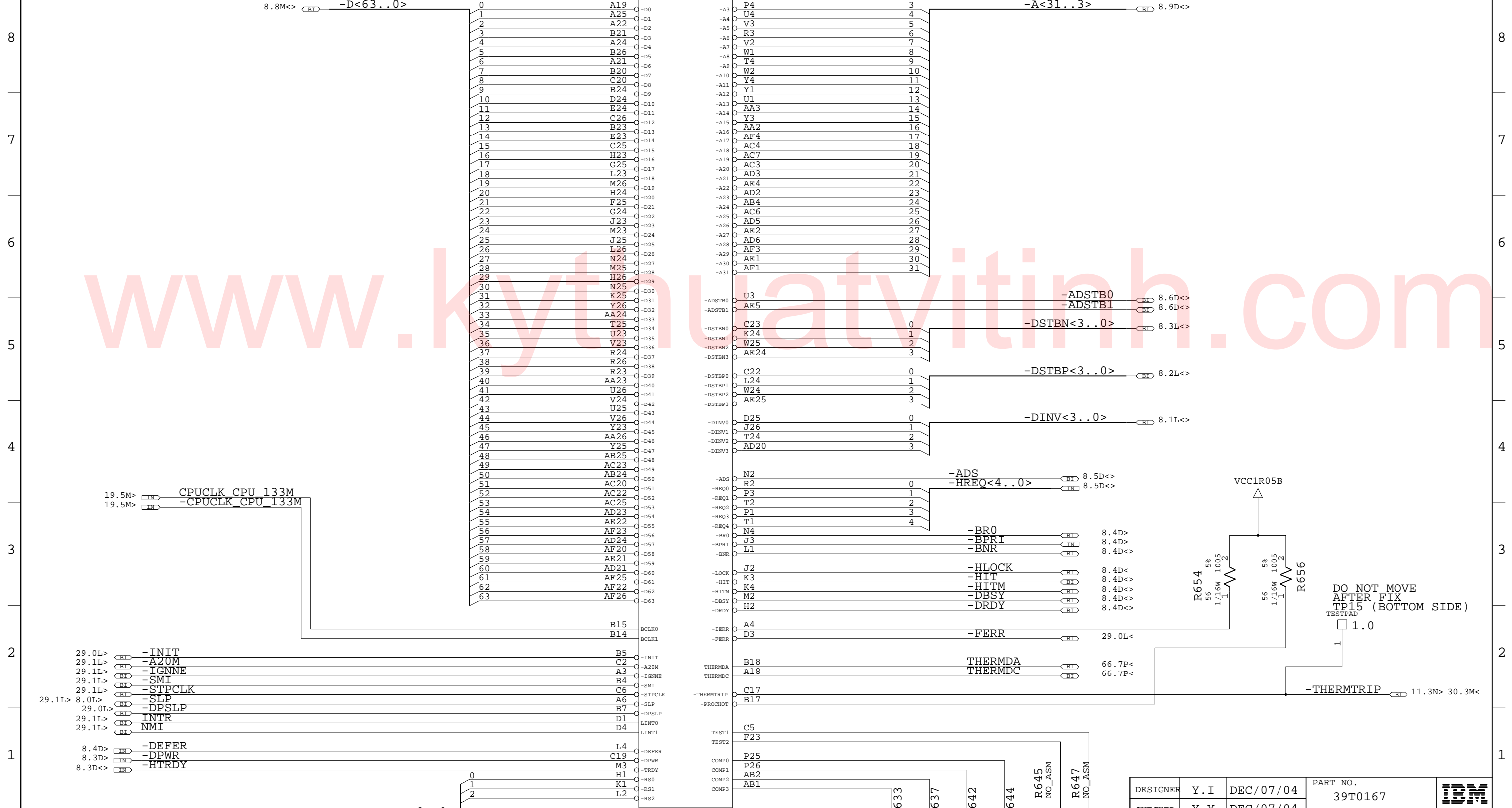

19.5M> CPUCLK CPU_133M
 19.5M> -CPUCLK CPU_133M

29.0L> -INIT
 29.1L> -A20M
 29.1L> -IGNNE
 29.1L> -SMI
 29.1L> -STPCLK
 8.0L> -SLP
 29.0L> -DPSLP
 29.1L> INTR
 29.1L> NMI
 8.4D> -DEFER
 8.3D> -DPWR
 8.3D> -HTRDY

8.3D> -RS<2..0>

COMP0/2: Z0=27.4 OHM TRACE
 COMP1/3: Z0=55 OHM

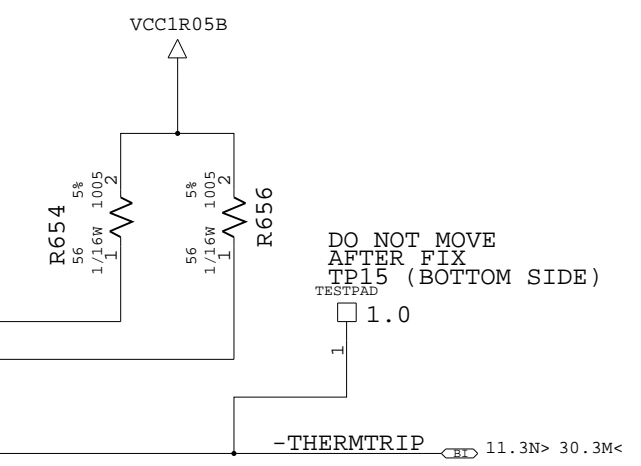
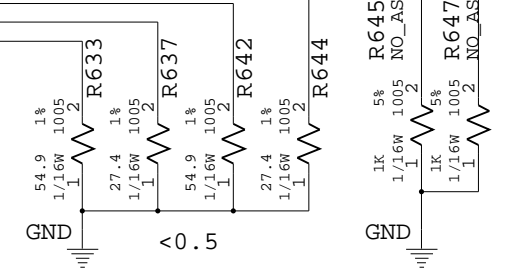

39T0167

DESIGNER	Y.I	DEC/07/04	PART NO.	IBM
CHECKED	Y.Y	DEC/07/04	39T0167	
APPROVED	T.S	DEC/07/04	TITLE	ROME-4 SVT-R(V0.91)
CLASS	T.S	DEC/07/04		CPU(1/3)
THIS DOCUMENT IS THE PROPERTY OF IBM ITS USE IS AUTHORIZED ONLY FOR RESPONDING TO A REQUEST FOR QUOTATION OR FOR THE PERFORMANCE OF WORK FOR IBM. ALL QUESTIONS MUST BE REFERRED TO THE IBM PURCHASING DEPARTMENT.				IBM CONFIDENTIAL

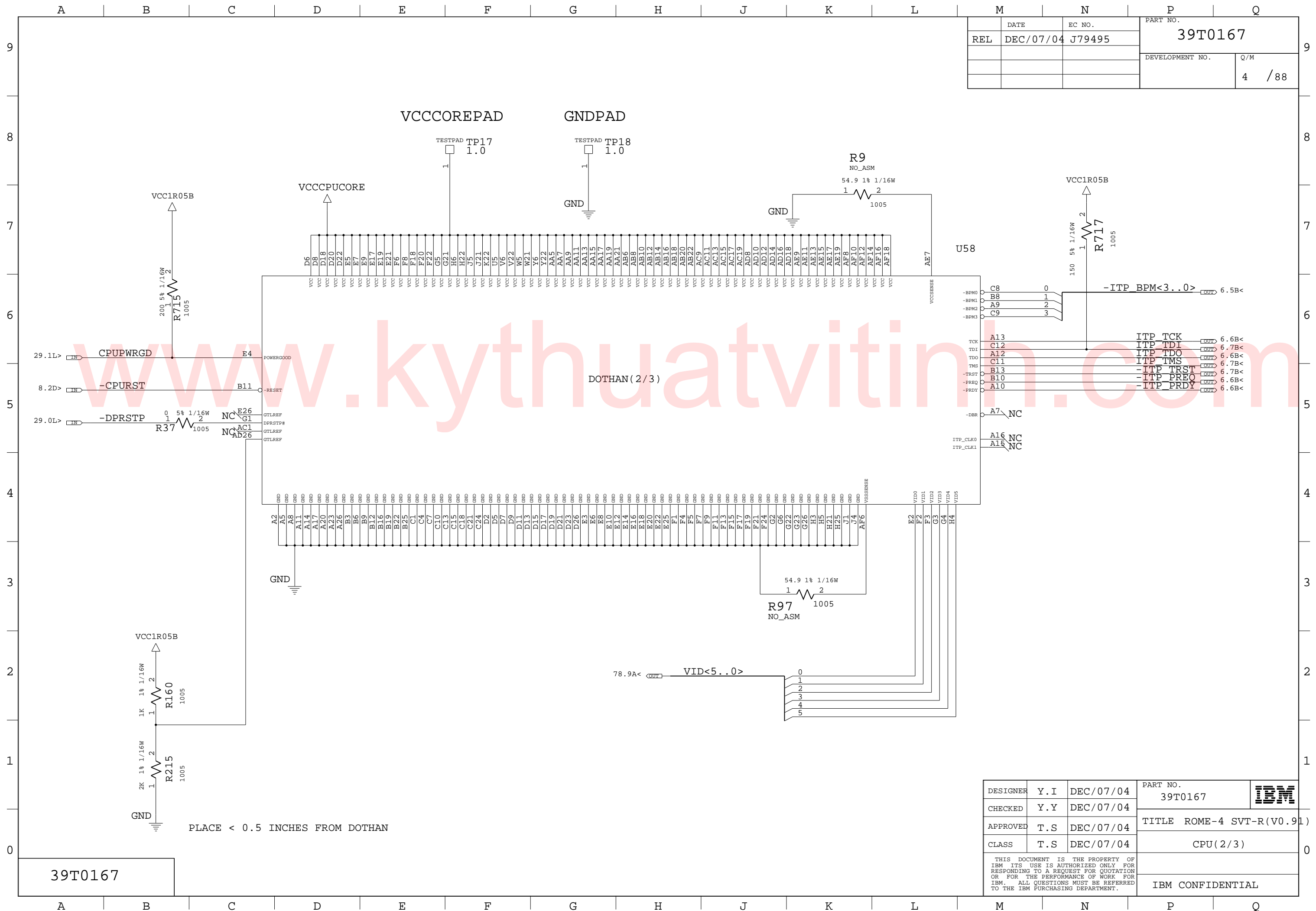

REL	DATE	EC NO.	PART NO.
	DEC/07/04	J79495	39T0167
			DEVELOPMENT NO.
			Q/M
			4 / 88

DOTHAN (2/3)

PLACE < 0.5 INCHES FROM DOTHAN

39T0167

DESIGNER	Y. I	DEC/07/04	PART NO.	IBM
CHECKED	Y. Y	DEC/07/04	39T0167	
APPROVED	T. S	DEC/07/04	TITLE ROME-4 SVT-R (V0.91)	
CLASS	T. S	DEC/07/04	CPU (2/3)	
THIS DOCUMENT IS THE PROPERTY OF IBM. ITS USE IS AUTHORIZED ONLY FOR RESPONDING TO A REQUEST FOR QUOTATION OR FOR THE PERFORMANCE OF WORK FOR IBM. ALL QUESTIONS MUST BE REFERRED TO THE IBM PURCHASING DEPARTMENT.				IBM CONFIDENTIAL

DATE	EC NO.	PART NO.
REL DEC/07/04	J79495	39T0167
DEVELOPMENT NO.		Q/M
		5 / 88

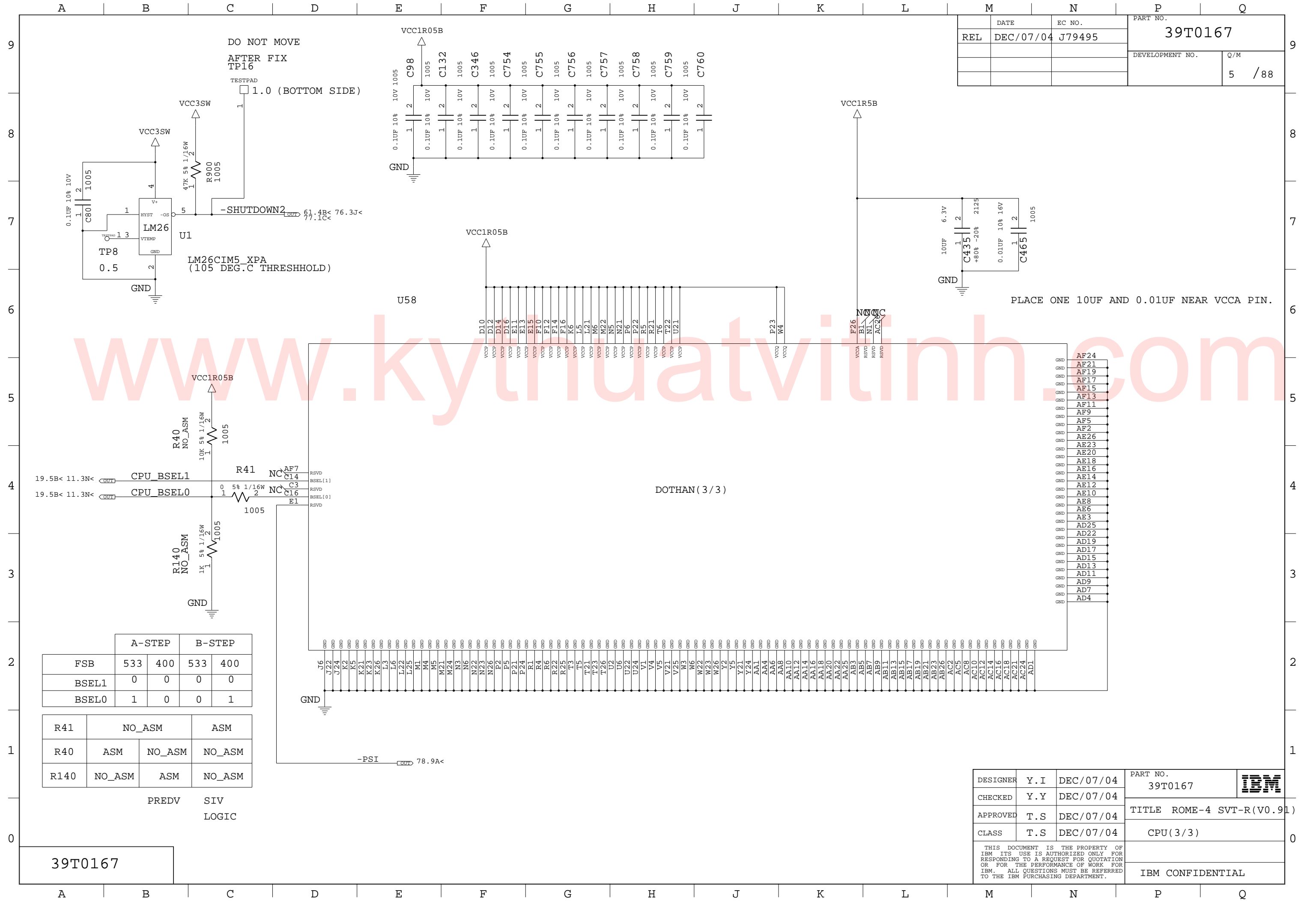

DO THAN (3/3)

PLACE ONE 10UF AND 0.01UF NEAR VCCA PIN.

	A-STEP		B-STEP	
FSB	533	400	533	400
BSEL1	0	0	0	0
BSEL0	1	0	0	1

R41	NO_ASM		ASM
R40	ASM	NO_ASM	NO_ASM
R140	NO_ASM	ASM	NO_ASM

PREDRV SIV LOGIC

DESIGNER	Y.I	DEC/07/04	PART NO.	39T0167	
CHECKED	Y.Y	DEC/07/04	TITLE ROME-4 SVT-R(V0.91)		
APPROVED	T.S	DEC/07/04	CPU(3/3)		
CLASS	T.S	DEC/07/04	IBM CONFIDENTIAL		

39T0167

	DATE	EC NO.	PART NO.
REL	DEC/07/04	J79495	39T0167
			DEVELOPMENT NO.
			Q/M
			6 / 88

LARGE PTH HOLE

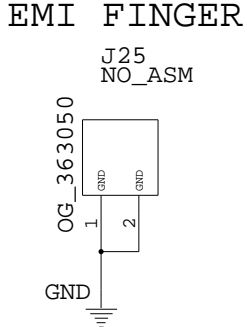
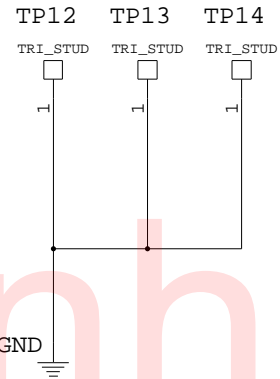
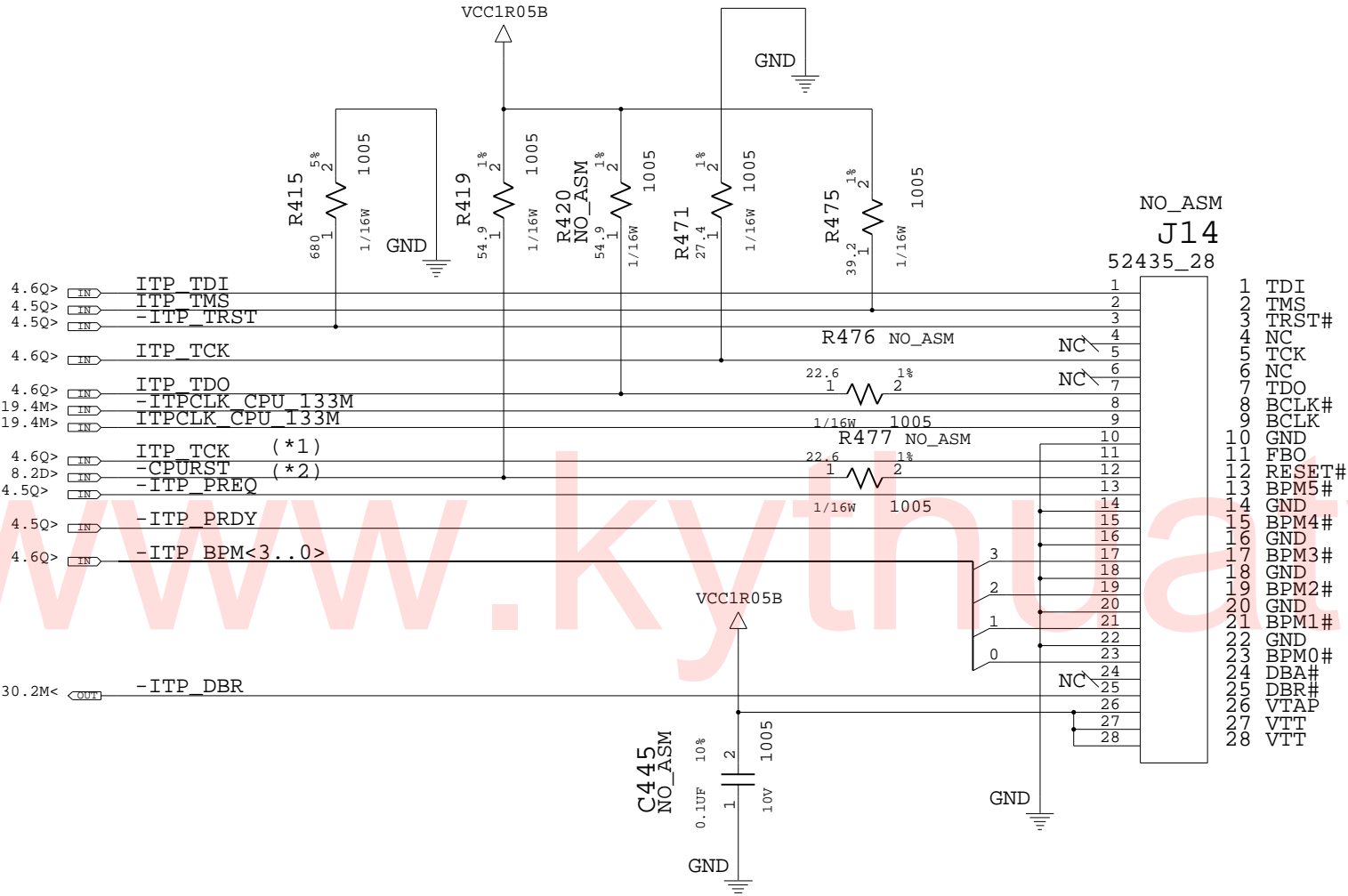

(*1) TCK SIGNAL IS BRANCHED AT DOTHAN PIN
 (*2) -CPURST SIGNAL IS BRANCHED AT ALVISO PIN

39T0167

DESIGNER	Y.I	DEC/07/04	PART NO.	39T0167	IBM
CHECKED	Y.Y	DEC/07/04			
APPROVED	T.S	DEC/07/04	TITLE ROME-4 SVT-R(V0.91)		
CLASS	T.S	DEC/07/04	ITP CONN/LARGE PTH HOLE		
THIS DOCUMENT IS THE PROPERTY OF IBM ITS USE IS AUTHORIZED ONLY FOR RESPONDING TO A REQUEST FOR QUOTATION OR FOR THE PERFORMANCE OF WORK FOR IBM. ALL QUESTIONS MUST BE REFERRED TO THE IBM PURCHASING DEPARTMENT.				EMI FINGER	
				IBM CONFIDENTIAL	

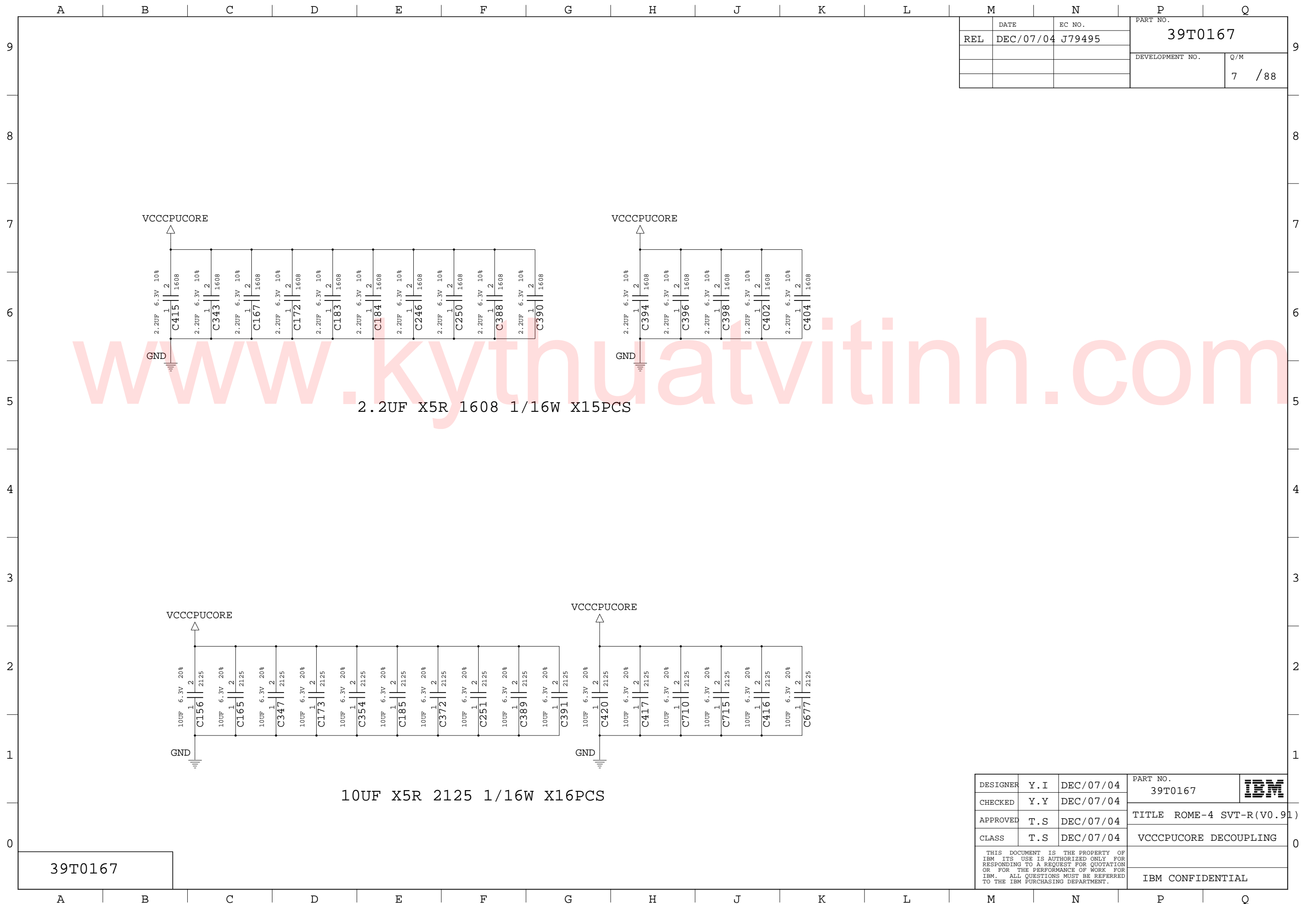

	DATE	EC NO.	PART NO.	
REL	DEC/07/04	J79495	39T0167	
			DEVELOPMENT NO.	Q/M
				7 / 88

39T0167

10UF X5R 2125 1/16W X16PCS

2.2UF X5R 1608 1/16W X15PCS

DESIGNER	Y. I	DEC/07/04	PART NO.	IBM
CHECKED	Y. Y	DEC/07/04	39T0167	
APPROVED	T. S	DEC/07/04	TITLE ROME-4 SVT-R (V0.91)	
CLASS	T. S	DEC/07/04	VCCCPUCORE DECOUPLING	
THIS DOCUMENT IS THE PROPERTY OF IBM. ITS USE IS AUTHORIZED ONLY FOR RESPONDING TO A REQUEST FOR QUOTATION OR FOR THE PERFORMANCE OF WORK FOR IBM. ALL QUESTIONS MUST BE REFERRED TO THE IBM PURCHASING DEPARTMENT.				IBM CONFIDENTIAL

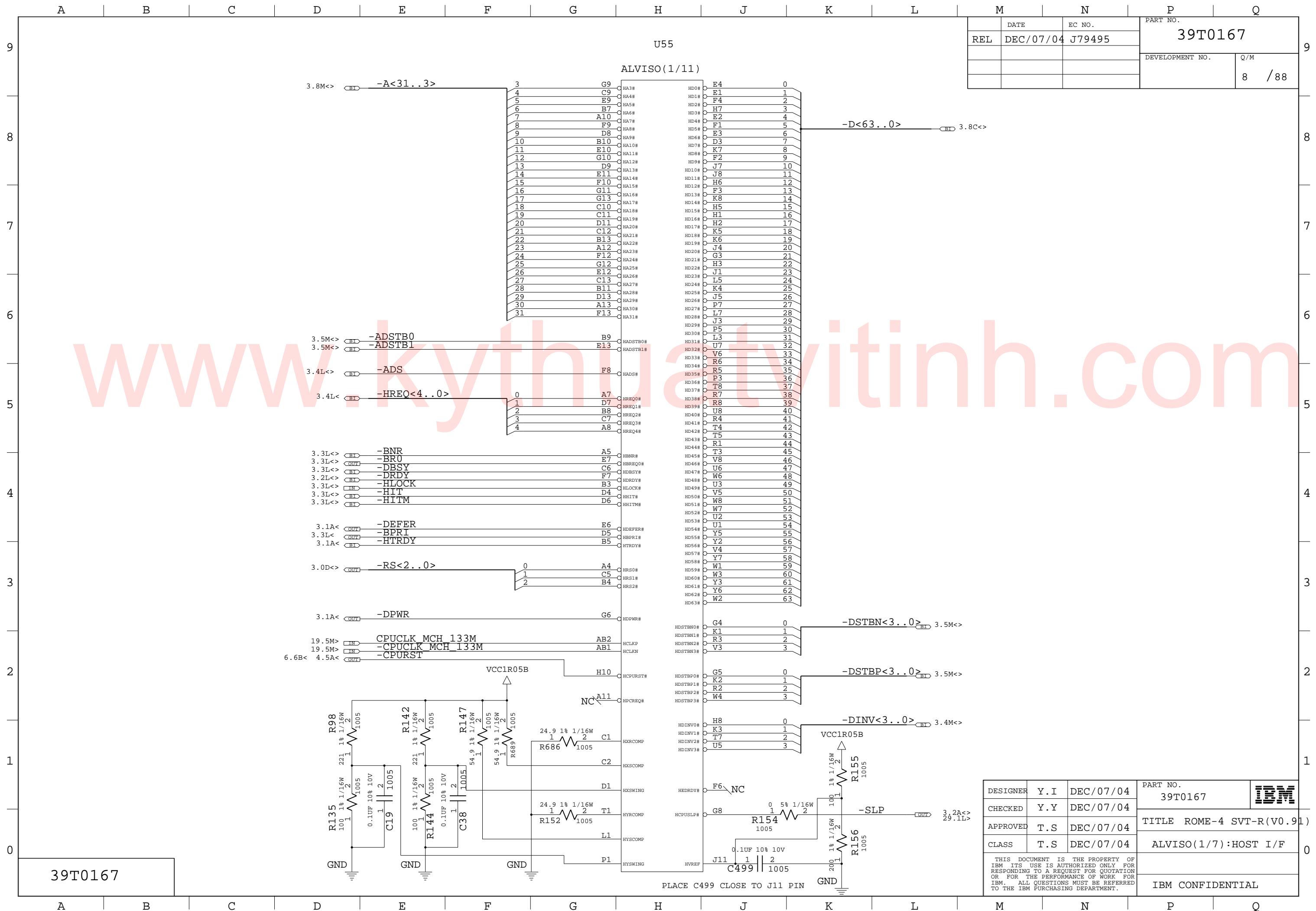

REL	DATE DEC/07/04	EC NO. J79495	PART NO. 39T0167
			DEVELOPMENT NO. 8 / 88

DESIGNER	Y.I	DEC/07/04	PART NO. 39T0167	IBM
CHECKED	Y.Y	DEC/07/04	TITLE ROME-4 SVT-R(V0.91)	
APPROVED	T.S	DEC/07/04	ALVISO(1/7):HOST I/F	
CLASS	T.S	DEC/07/04	IBM CONFIDENTIAL	

THIS DOCUMENT IS THE PROPERTY OF IBM. ITS USE IS AUTHORIZED ONLY FOR RESPONDING TO A REQUEST FOR QUOTATION OR FOR THE PERFORMANCE OF WORK FOR IBM. ALL QUESTIONS MUST BE REFERRED TO THE IBM PURCHASING DEPARTMENT.

39T0167

PLACE C499 CLOSE TO J11 PIN

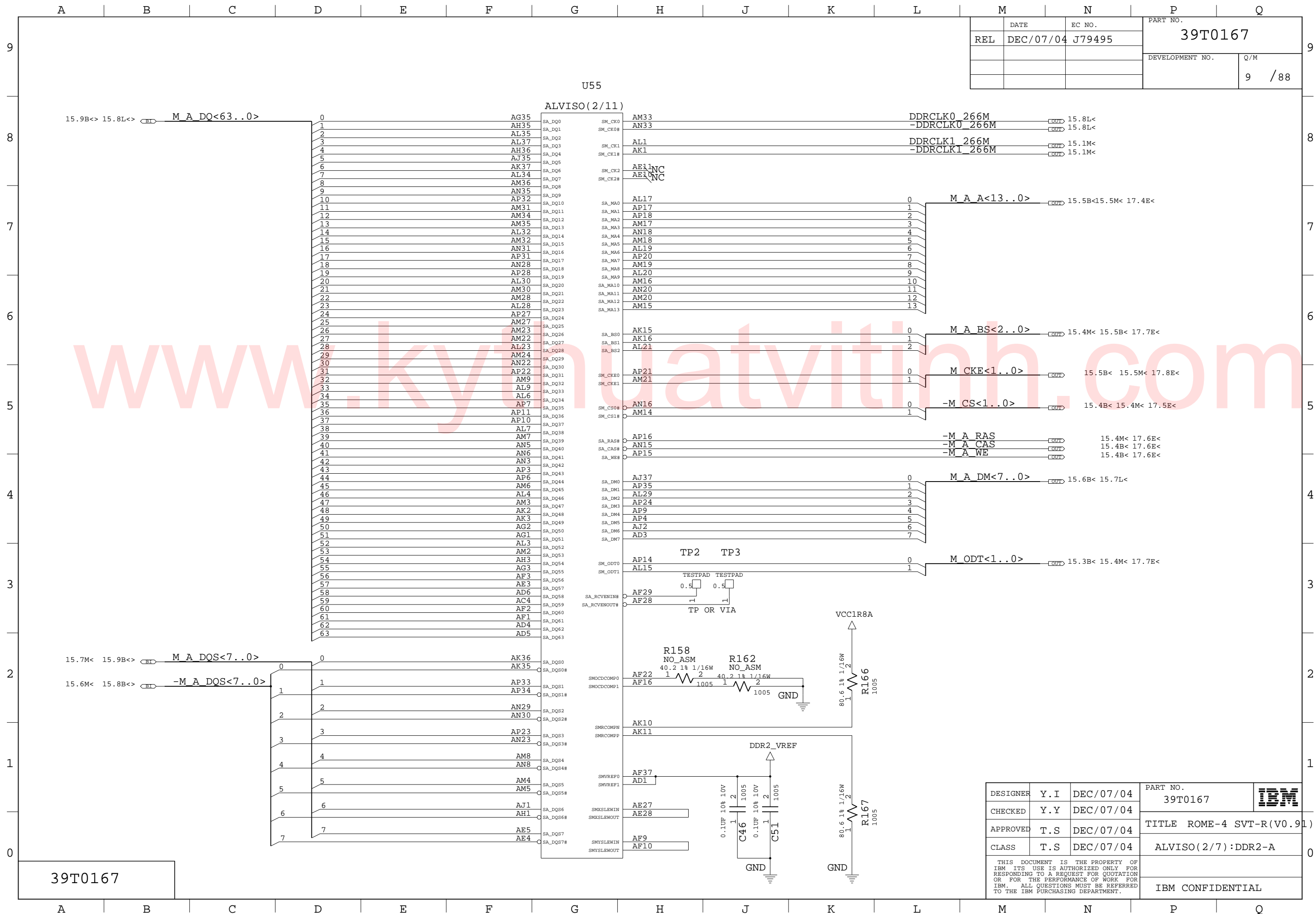

DATE	DEC/07/04	EC NO.	J79495	PART NO.	39T0167
REL				DEVELOPMENT NO.	9 / 88
				Q/M	

U55

ALVISO (2/11)

9
8
7
6
5
4
3
2
1
0

9
8
7
6
5
4
3
2
1
0

39T0167

DESIGNER	Y.I	DEC/07/04	PART NO.	39T0167	IBM
CHECKED	Y.Y	DEC/07/04	TITLE	ROME-4 SVT-R (V0.91)	
APPROVED	T.S	DEC/07/04	CLASS	ALVISO (2/7) : DDR2-A	
THIS DOCUMENT IS THE PROPERTY OF IBM. ITS USE IS AUTHORIZED ONLY FOR RESPONDING TO A REQUEST FOR QUOTATION OR FOR THE PERFORMANCE OF WORK FOR IBM. ALL QUESTIONS MUST BE REFERRED TO THE IBM PURCHASING DEPARTMENT.					IBM CONFIDENTIAL

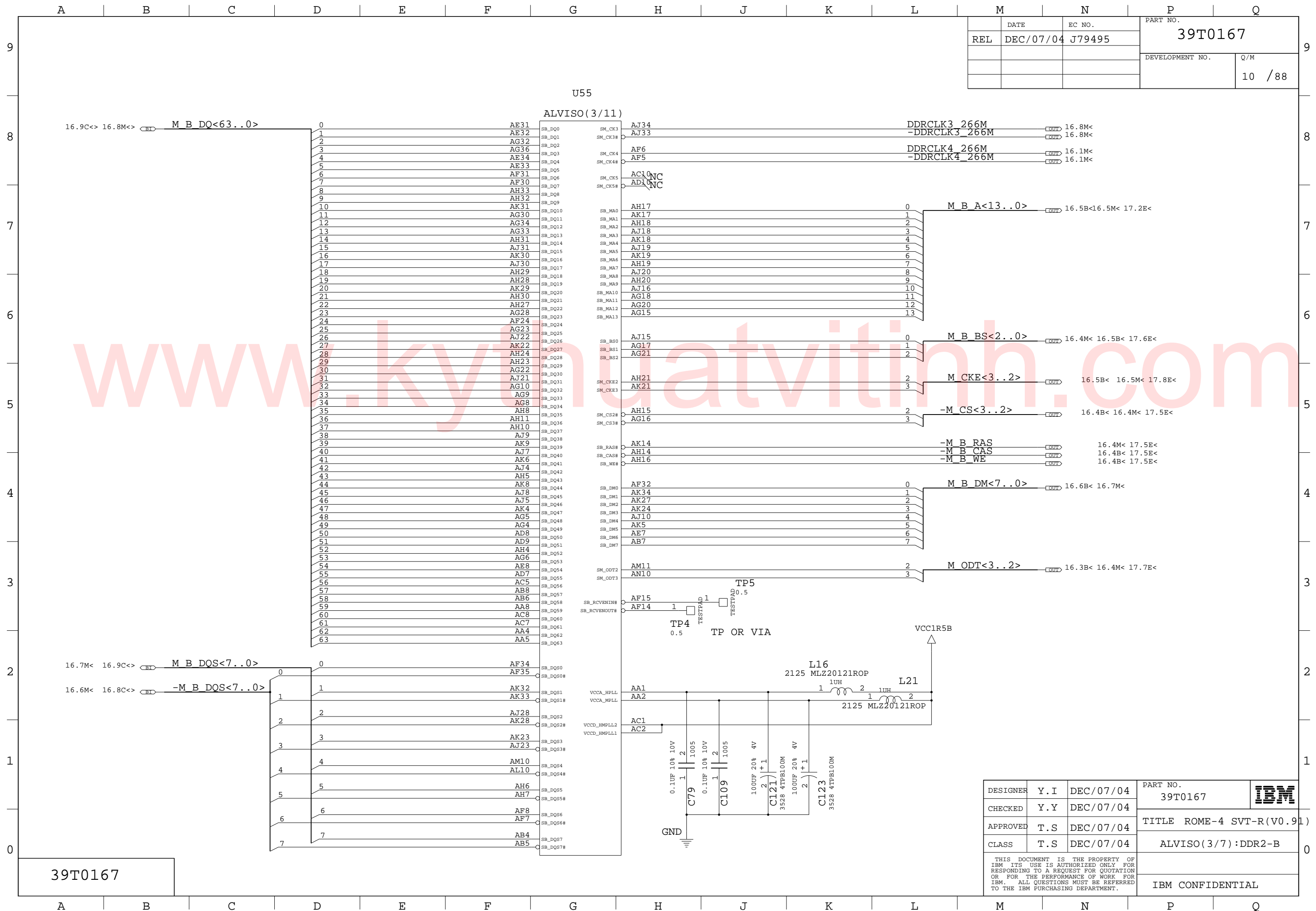

DATE	DEC/07/04	EC NO.	J79495	PART NO.	39T0167
REL				DEVELOPMENT NO.	Q/M
					10 / 88

39T0167

DESIGNER	Y.I	DEC/07/04	PART NO.	39T0167	IBM
CHECKED	Y.Y	DEC/07/04			
APPROVED	T.S	DEC/07/04	TITLE ROME-4 SVT-R(V0.91)		
CLASS	T.S	DEC/07/04	ALVISO(3/7):DDR2-B		
THIS DOCUMENT IS THE PROPERTY OF IBM. ITS USE IS AUTHORIZED ONLY FOR RESPONDING TO A REQUEST FOR QUOTATION OR FOR THE PERFORMANCE OF WORK FOR IBM. ALL QUESTIONS MUST BE REFERRED TO THE IBM PURCHASING DEPARTMENT.					IBM CONFIDENTIAL

DATE	DEC/07/04	EC NO.	J79495	PART NO.	39T0167
REL				DEVELOPMENT NO.	11 / 88
				Q/M	

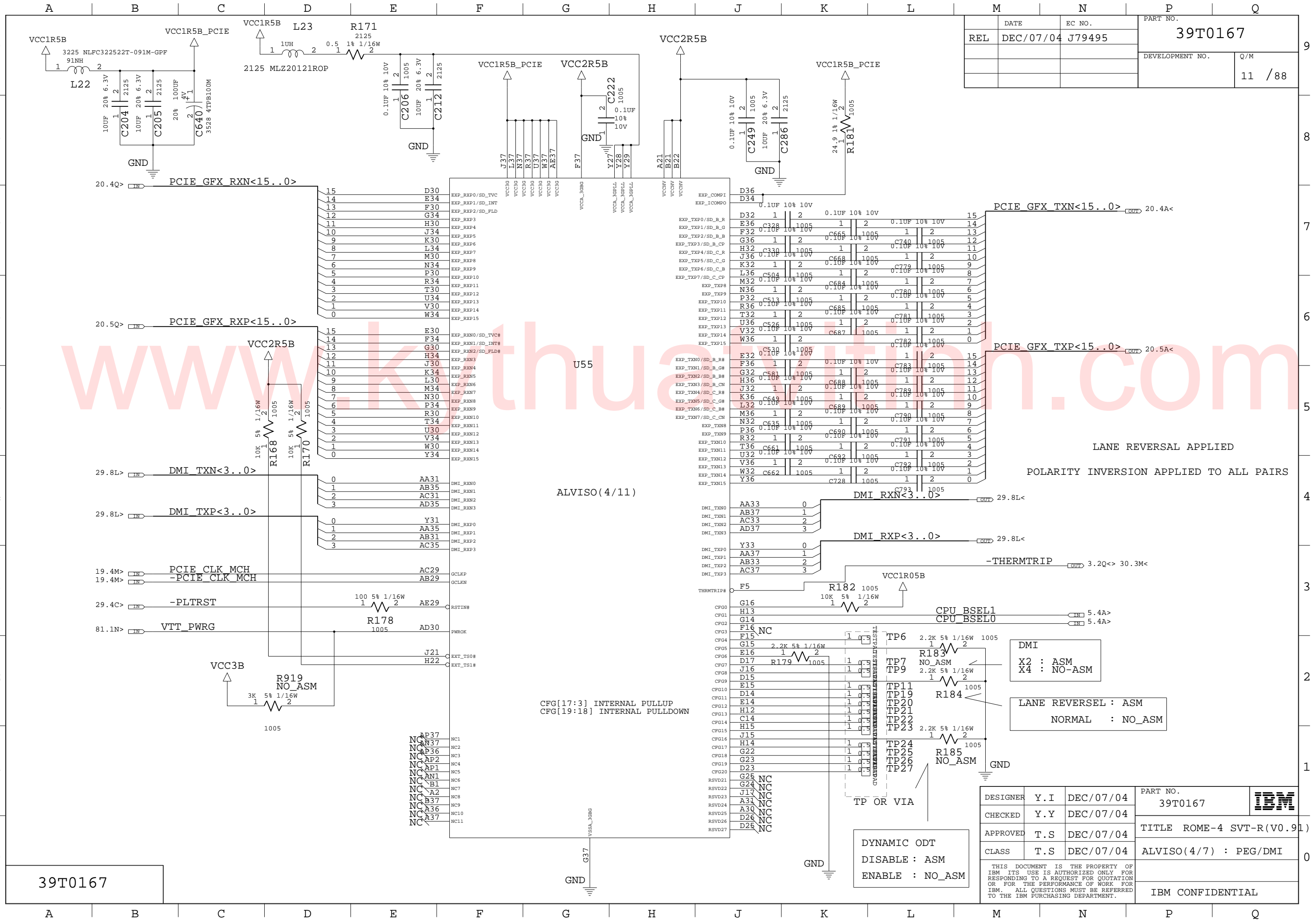

www.kthusa.com

PCIE GFX RXN<15..0> 20.4Q<

PCIE GFX TXP<15..0> 20.5A<

LANE REVERSAL APPLIED
POLARITY INVERSION APPLIED TO ALL PAIRS

ALVISO(4/11)

-THERMTRIP 3.2Q< 30.3M<

CPU BSEL1 5.4A<
CPU BSEL0 5.4A<

DMI
X2 : ASM
X4 : NO-ASM

LANE REVERSEL : ASM
NORMAL : NO_ASM

DYNAMIC ODT
DISABLE : ASM
ENABLE : NO_ASM

39T0167

DESIGNER	Y.I	DEC/07/04	PART NO.	39T0167	
CHECKED	Y.Y	DEC/07/04	TITLE	ROME-4 SVT-R(V0.91)	
APPROVED	T.S	DEC/07/04	CLASS	ALVISO(4/7) : PEG/DMI	
			THIS DOCUMENT IS THE PROPERTY OF IBM ITS USE IS AUTHORIZED ONLY FOR RESPONDING TO A REQUEST FOR QUOTATION OR FOR THE PERFORMANCE OF WORK FOR IBM. ALL QUESTIONS MUST BE REFERRED TO THE IBM PURCHASING DEPARTMENT.		
			IBM CONFIDENTIAL		

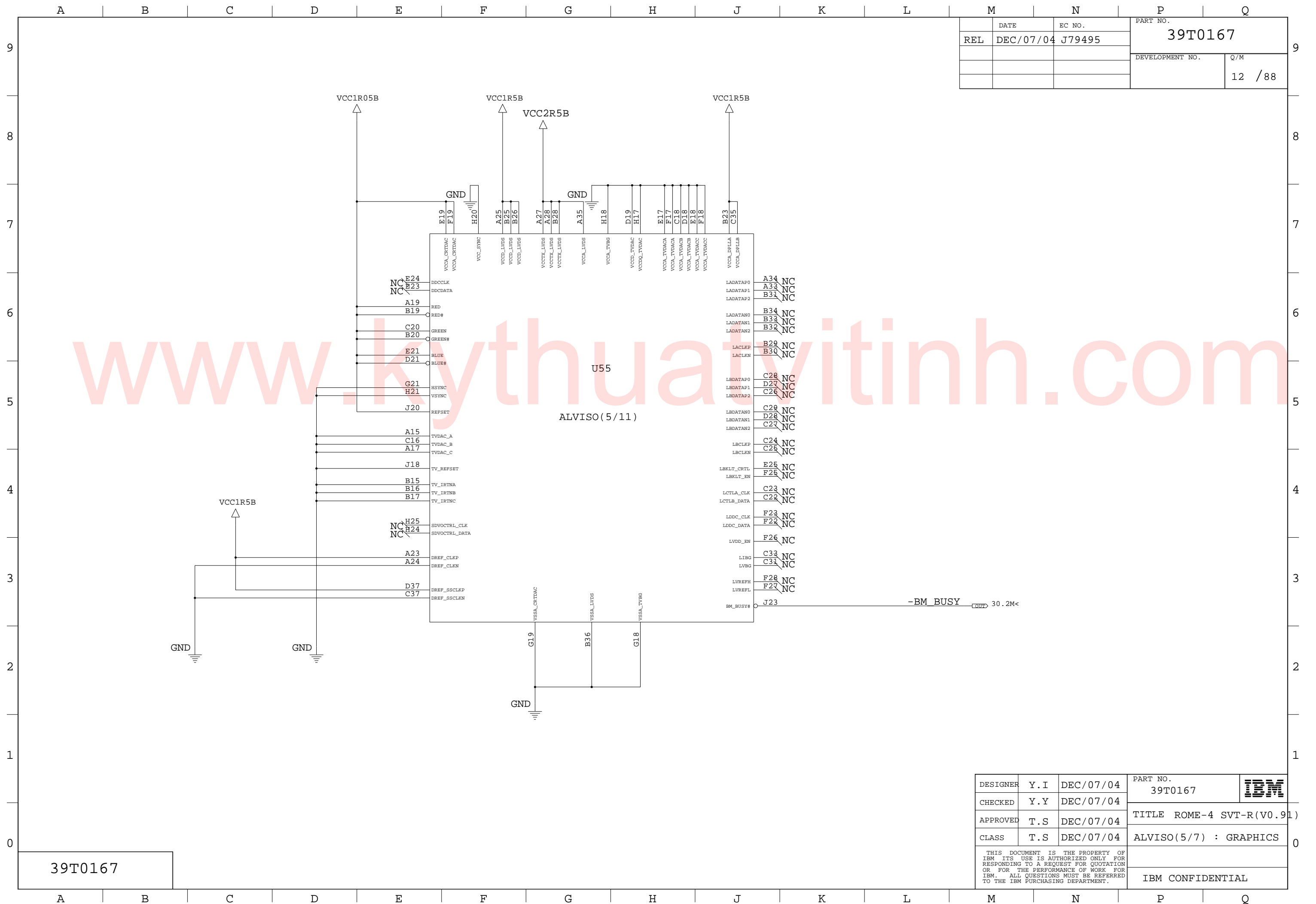

	DATE	EC NO.	PART NO.	
REL	DEC/07/04	J79495	39T0167	
			DEVELOPMENT NO.	Q/M
				12 / 88

39T0167

DESIGNER	Y. I	DEC/07/04	PART NO.	39T0167	
CHECKED	Y. Y	DEC/07/04			
APPROVED	T. S	DEC/07/04	TITLE ROME-4 SVT-R(V0.91)		
CLASS	T. S	DEC/07/04	ALVISO(5/7) : GRAPHICS		
THIS DOCUMENT IS THE PROPERTY OF IBM. ITS USE IS AUTHORIZED ONLY FOR RESPONDING TO A REQUEST FOR QUOTATION OR FOR THE PERFORMANCE OF WORK FOR IBM. ALL QUESTIONS MUST BE REFERRED TO THE IBM PURCHASING DEPARTMENT.				IBM CONFIDENTIAL	

DATE	DEC/07/04	EC NO.	J79495	PART NO.	39T0167
REL				DEVELOPMENT NO.	13 / 88
				Q/M	

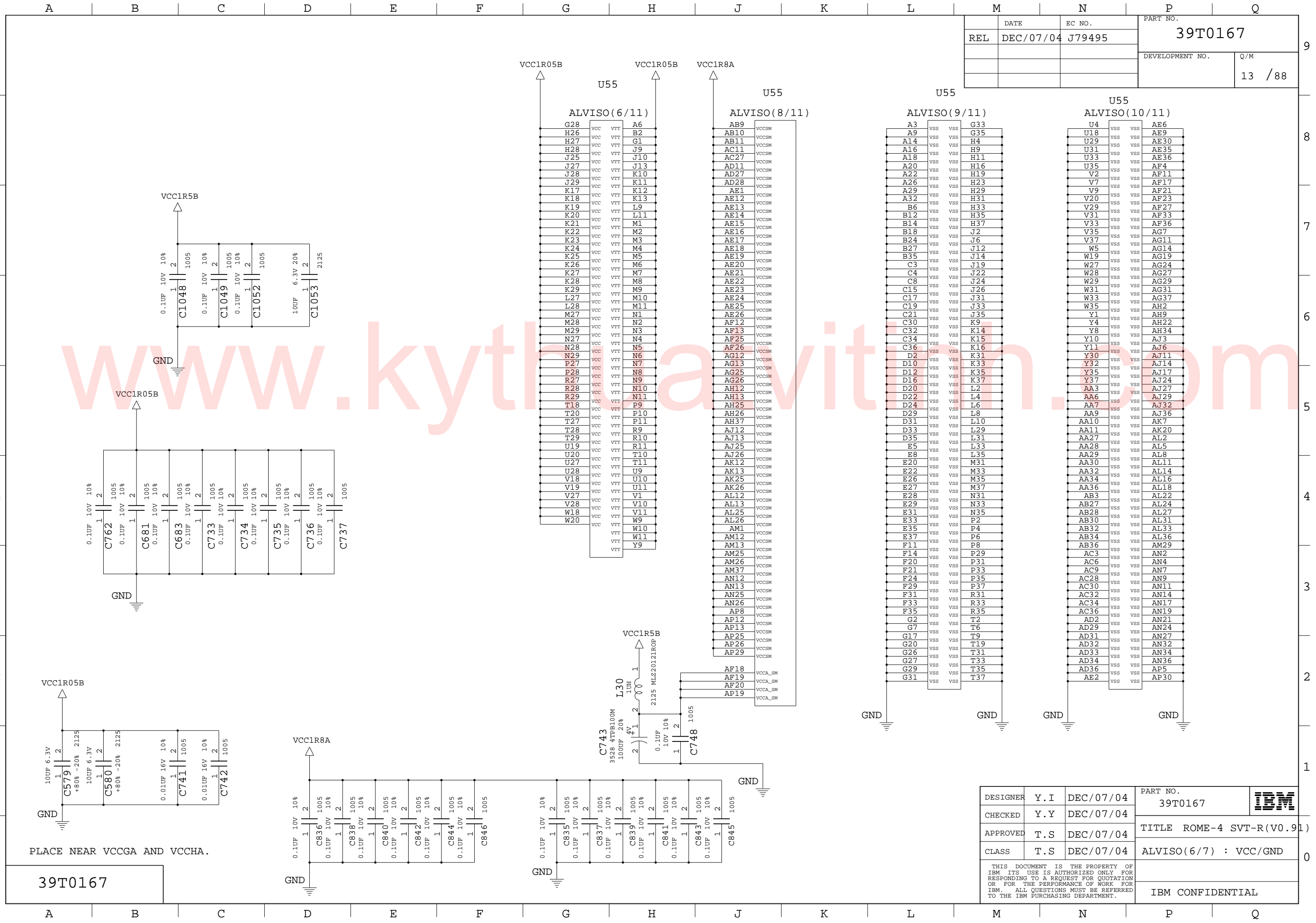

PLACE NEAR VCCGA AND VCCHA.

39T0167

DESIGNER	Y.I	DEC/07/04	PART NO.	39T0167	IBM
CHECKED	Y.Y	DEC/07/04	TITLE	ROME-4 SVT-R(V0.91)	
APPROVED	T.S	DEC/07/04	CLASS	ALVISO(6/7) : VCC/GND	
			THIS DOCUMENT IS THE PROPERTY OF IBM. ITS USE IS AUTHORIZED ONLY FOR RESPONDING TO A REQUEST FOR QUOTATION OR FOR THE PERFORMANCE OF WORK FOR IBM. ALL QUESTIONS MUST BE REFERRED TO THE IBM PURCHASING DEPARTMENT.		
			IBM CONFIDENTIAL		

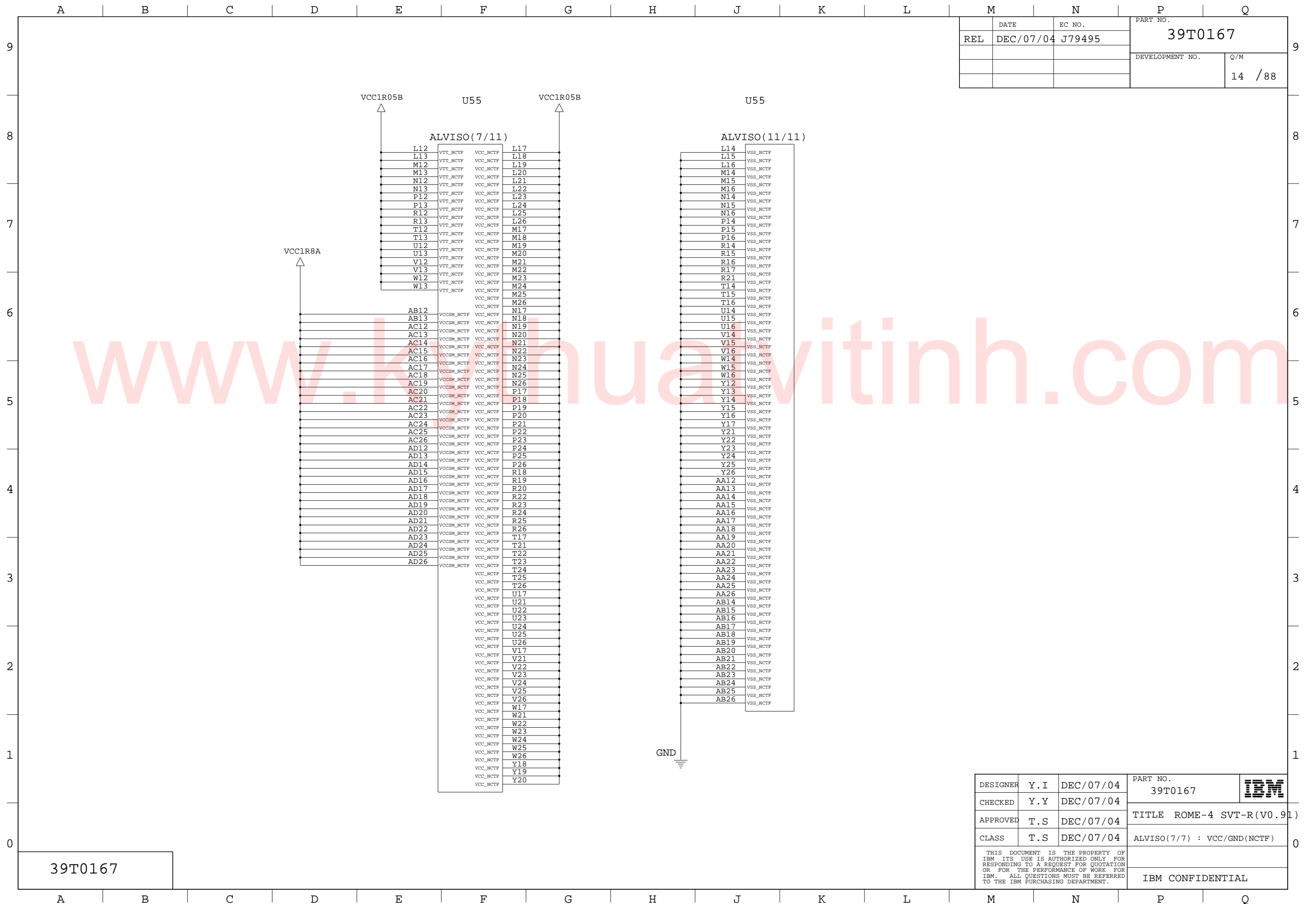

	DATE	EC NO.	PART NO.	
REL	DEC/07/04	J79495	39T0167	
			DEVELOPMENT NO.	Q/M
				14 / 88

39T0167

DESIGNER	Y. I	DEC/07/04	PART NO.	39T0167	IBM
CHECKED	Y. Y	DEC/07/04			
APPROVED	T. S	DEC/07/04	TITLE ROME-4 SVT-R (V0.91)		
CLASS	T. S	DEC/07/04	ALVISO(7/7) : VCC/GND(NCTF)		
THIS DOCUMENT IS THE PROPERTY OF IBM ITS USE IS AUTHORIZED ONLY FOR RESPONDING TO A REQUEST FOR QUOTATION OR FOR THE PERFORMANCE OF WORK FOR IBM. ALL QUESTIONS MUST BE REFERRED TO THE IBM PURCHASING DEPARTMENT.				IBM CONFIDENTIAL	

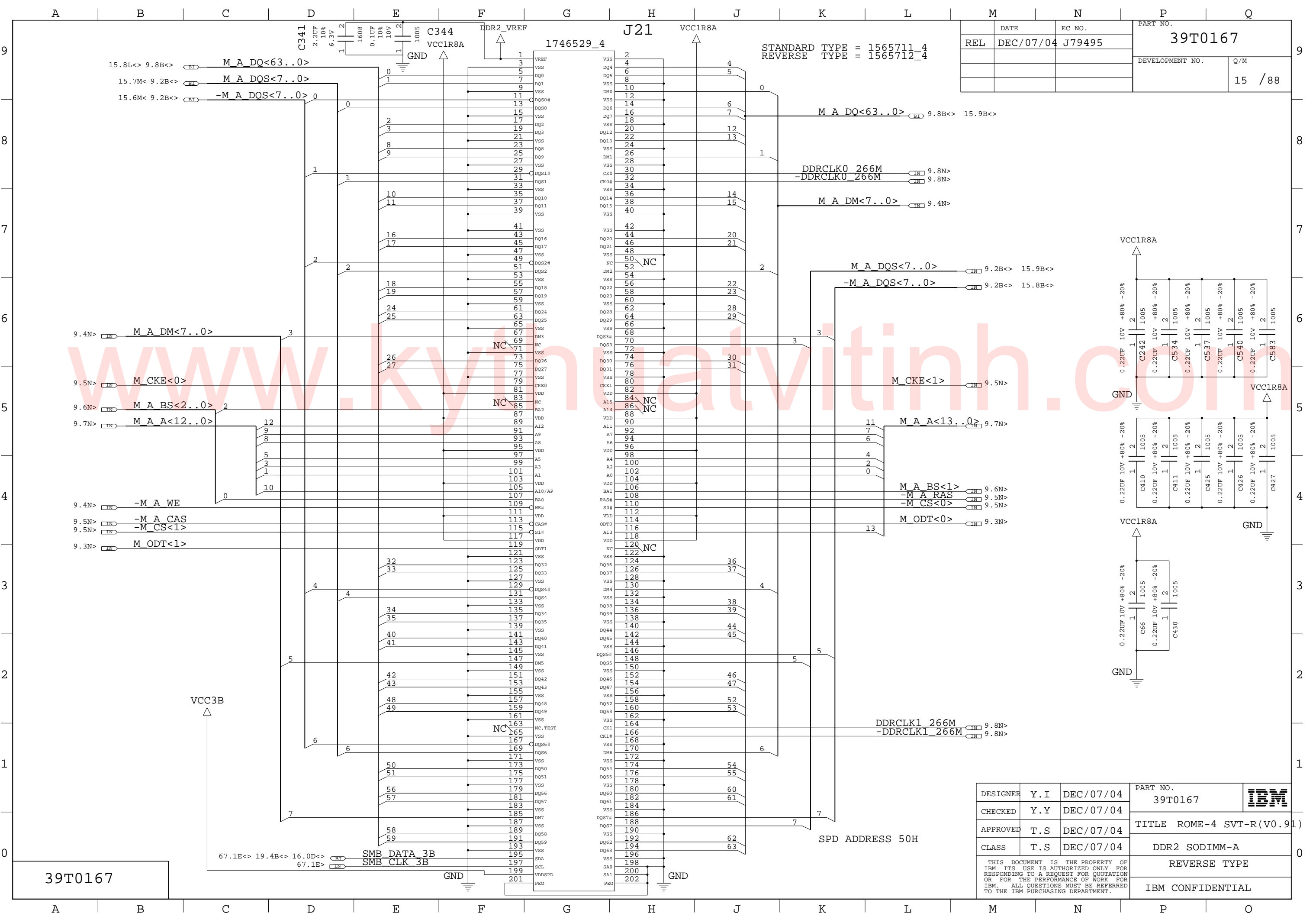

DATE	DEC/07/04	EC NO.	J79495	PART NO.	39T0167
REL				DEVELOPMENT NO.	15 / 88
				Q/M	

STANDARD TYPE = 1565711_4
 REVERSE TYPE = 1565712_4

DESIGNER	Y.I	DEC/07/04	PART NO.	39T0167	
CHECKED	Y.Y	DEC/07/04			
APPROVED	T.S	DEC/07/04	TITLE ROME-4 SVT-R(V0.91)		
CLASS	T.S	DEC/07/04	DDR2 SODIMM-A		
THIS DOCUMENT IS THE PROPERTY OF IBM ITS USE IS AUTHORIZED ONLY FOR RESPONDING TO A REQUEST FOR QUOTATION OR FOR THE PERFORMANCE OF WORK FOR IBM. ALL QUESTIONS MUST BE REFERRED TO THE IBM PURCHASING DEPARTMENT.					REVERSE TYPE
					IBM CONFIDENTIAL

39T0167

SPD ADDRESS 50H

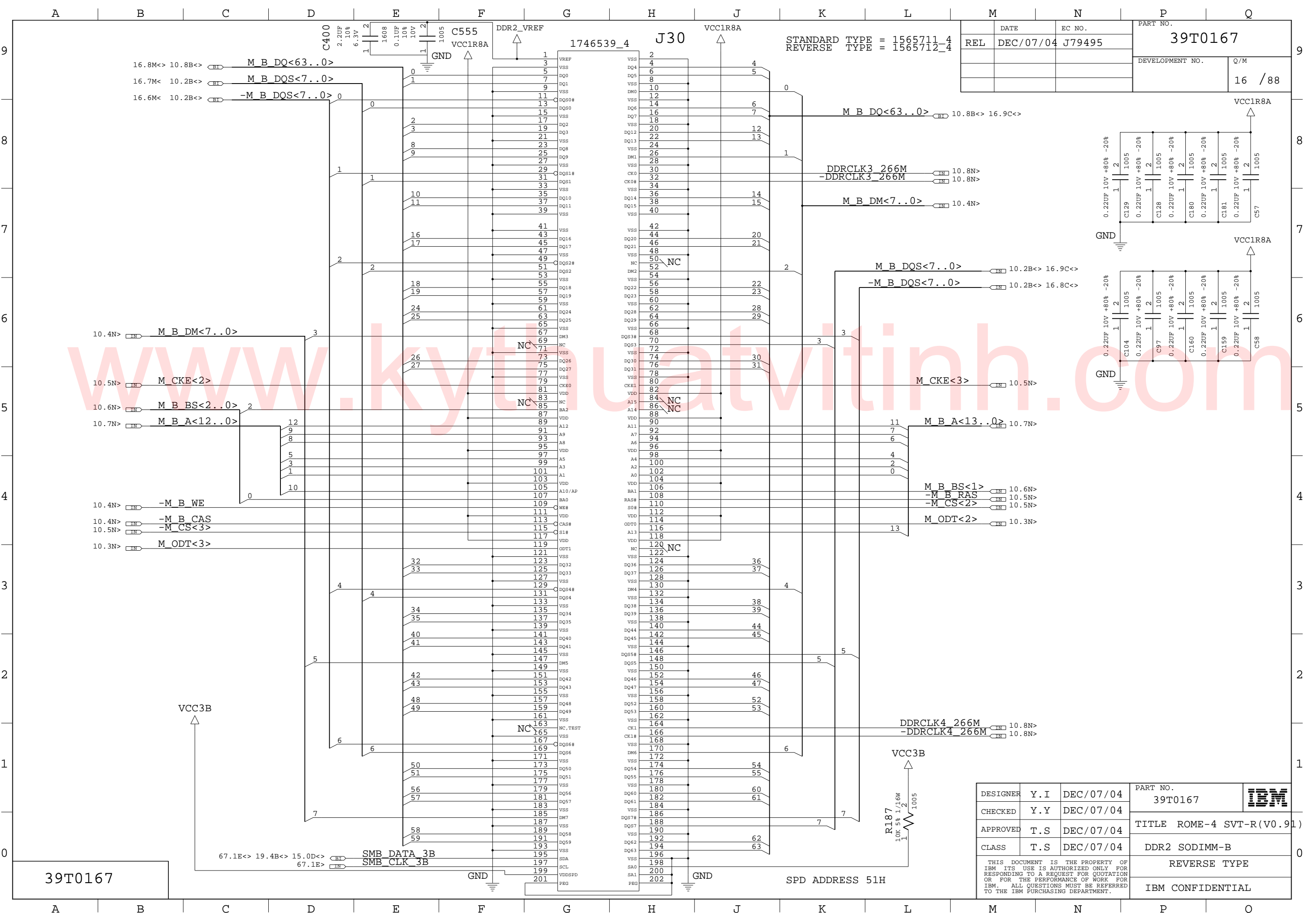

DATE	DEC/07/04	EC NO.	J79495	PART NO.	39T0167
REL				DEVELOPMENT NO.	16 / 88

DESIGNER	Y.I	DEC/07/04	PART NO.	39T0167	
CHECKED	Y.Y	DEC/07/04	TITLE ROME-4 SVT-R (V0.91)		
APPROVED	T.S	DEC/07/04	DDR2 SODIMM-B		
CLASS	T.S	DEC/07/04	REVERSE TYPE		
THIS DOCUMENT IS THE PROPERTY OF IBM. ITS USE IS AUTHORIZED ONLY FOR RESPONDING TO A REQUEST FOR QUOTATION OR FOR THE PERFORMANCE OF WORK FOR IBM. ALL QUESTIONS MUST BE REFERRED TO THE IBM PURCHASING DEPARTMENT.					IBM CONFIDENTIAL

39T0167

STANDARD TYPE = 1565711_4
REVERSE TYPE = 1565712_4

SPD ADDRESS 51H

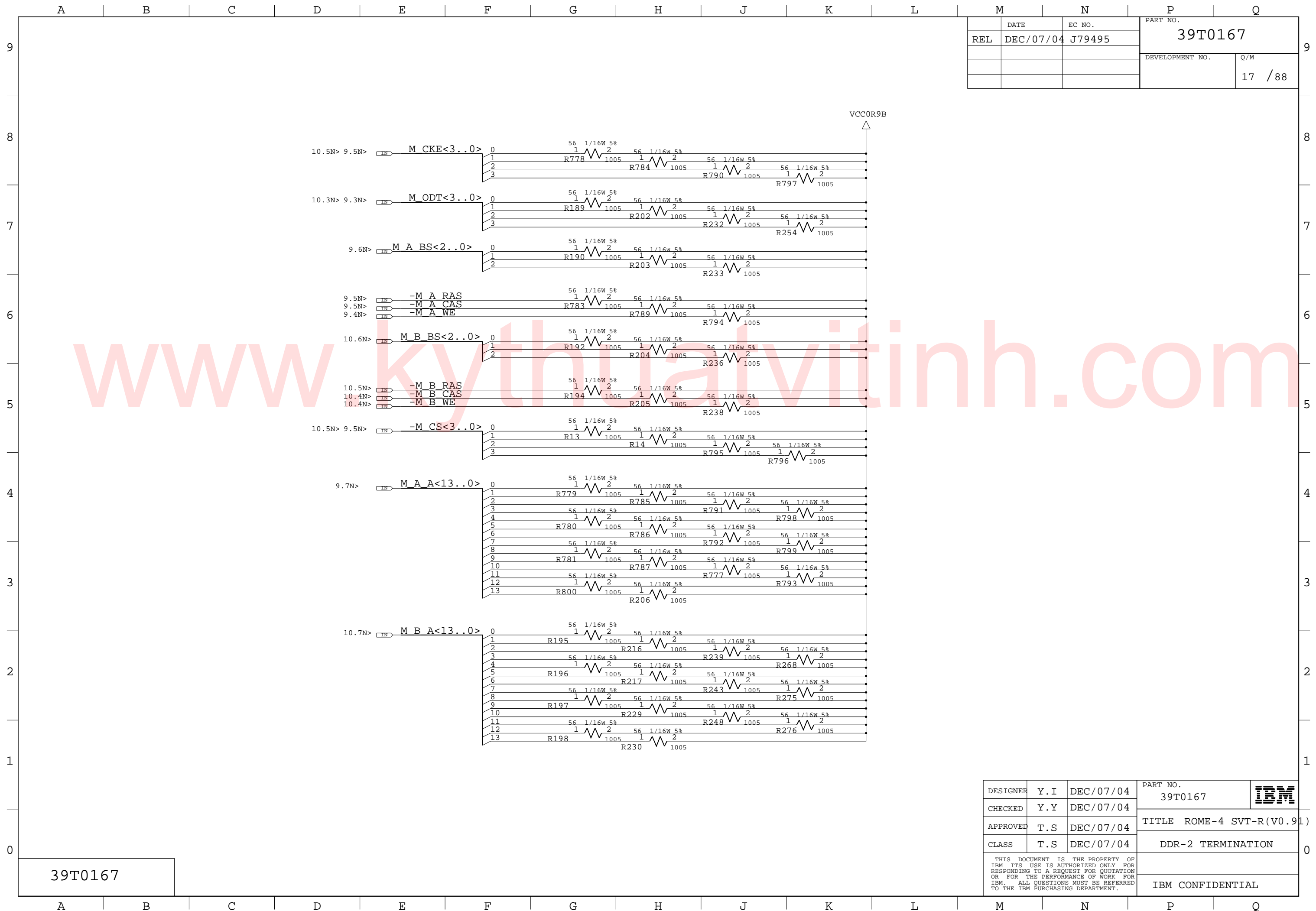

	DATE	EC NO.	PART NO.	
REL	DEC/07/04	J79495	39T0167	
			DEVELOPMENT NO.	Q/M
				17 /88

39T0167

DESIGNER	Y.I	DEC/07/04	PART NO.	IBM
CHECKED	Y.Y	DEC/07/04	39T0167	
APPROVED	T.S	DEC/07/04	TITLE ROME-4 SVT-R(V0.91)	
CLASS	T.S	DEC/07/04	DDR-2 TERMINATION	
THIS DOCUMENT IS THE PROPERTY OF IBM. ITS USE IS AUTHORIZED ONLY FOR RESPONDING TO A REQUEST FOR QUOTATION OR FOR THE PERFORMANCE OF WORK FOR IBM. ALL QUESTIONS MUST BE REFERRED TO THE IBM PURCHASING DEPARTMENT.				IBM CONFIDENTIAL

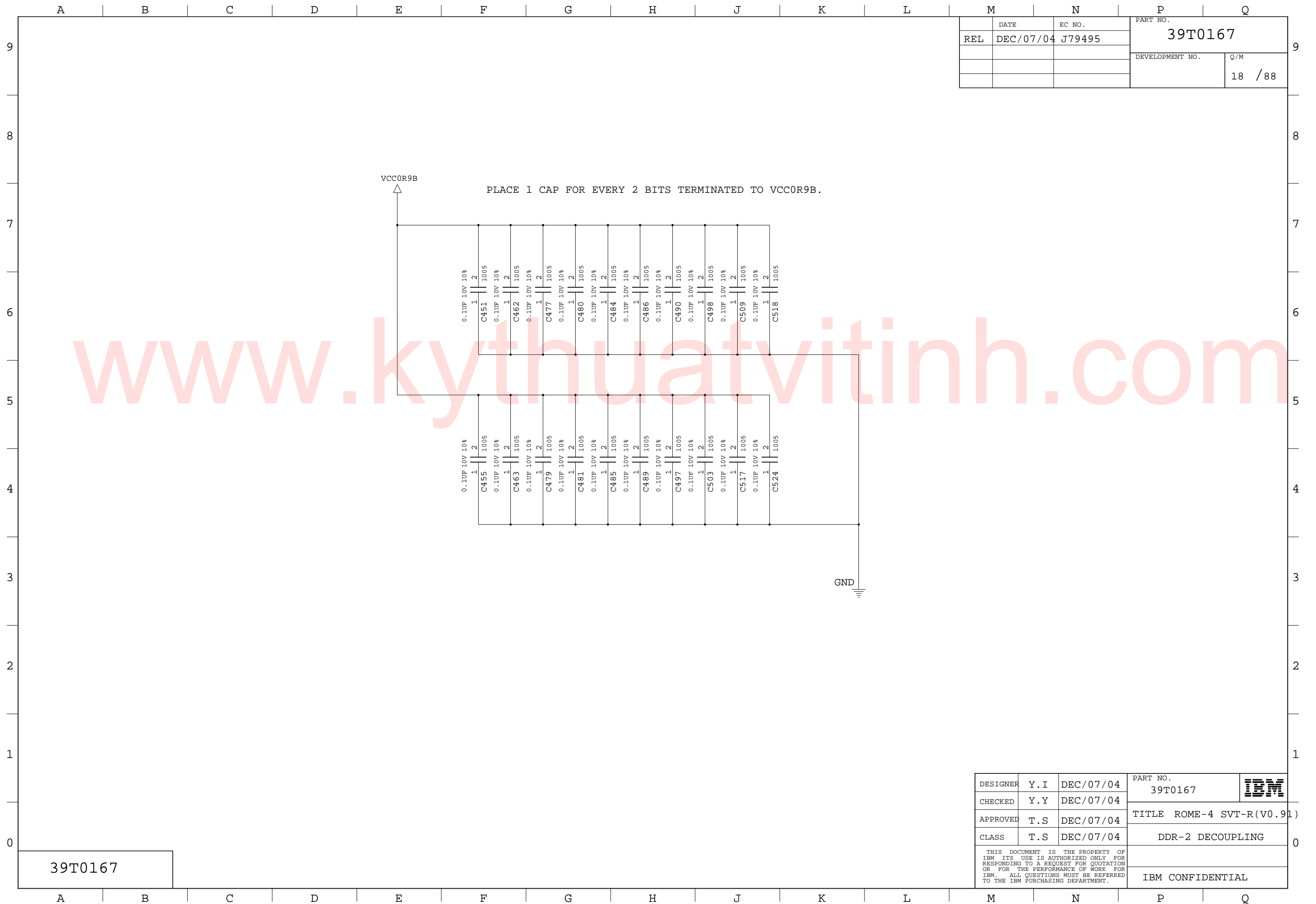

	DATE	EC NO.	PART NO.	
REL	DEC/07/04	J79495	39T0167	
			DEVELOPMENT NO.	Q/M
				18 / 88

39T0167

DESIGNER	Y. I	DEC/07/04	PART NO.	IBM
CHECKED	Y. Y	DEC/07/04	39T0167	
APPROVED	T. S	DEC/07/04	TITLE ROME-4 SVT-R (V0.91)	
CLASS	T. S	DEC/07/04	DDR-2 DECOUPLING	
THIS DOCUMENT IS THE PROPERTY OF IBM. ITS USE IS AUTHORIZED ONLY FOR RESPONDING TO A REQUEST FOR QUOTATION OR FOR THE PERFORMANCE OF WORK FOR IBM. ALL QUESTIONS MUST BE REFERRED TO THE IBM PURCHASING DEPARTMENT.				IBM CONFIDENTIAL

DATE	DEC/07/04	EC NO.	J79495	PART NO.	39T0167
REL				DEVELOPMENT NO.	Q/M
					19 / 88

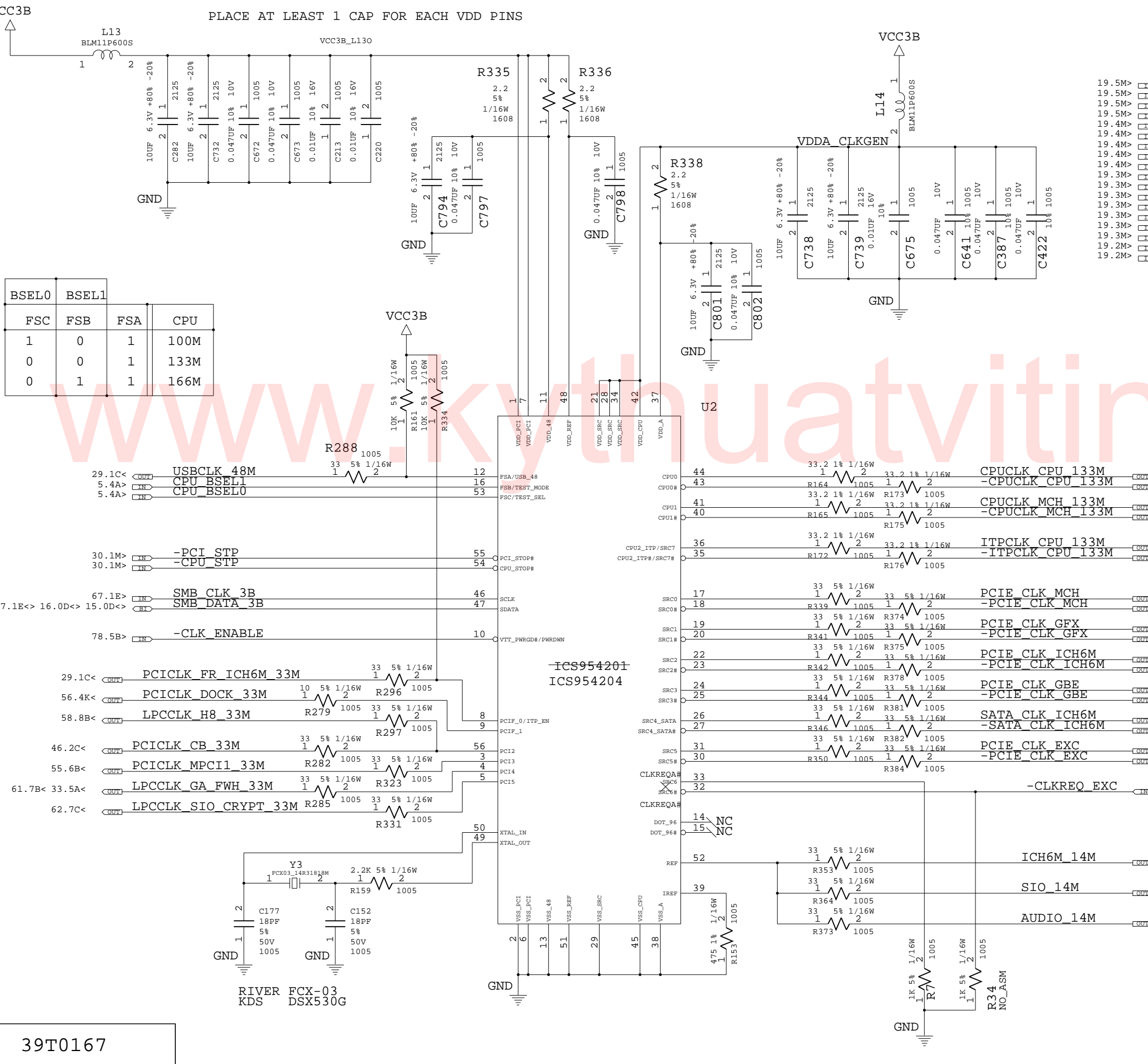

19.5M>	IN	CPUCCLK CPU 133M	49.9 1% 1/16W	1	R186	1005	49.9 1% 1/16W	1	R186	1005
19.5M>	IN	-CPUCCLK CPU 133M	49.9 1% 1/16W	2	R186	1005	49.9 1% 1/16W	2	R186	1005
19.5M>	IN	CPUCCLK MCH 133M	49.9 1% 1/16W	1	R469	1005	49.9 1% 1/16W	1	R469	1005
19.5M>	IN	-CPUCCLK MCH 133M	49.9 1% 1/16W	2	R469	1005	49.9 1% 1/16W	2	R469	1005
19.5M>	IN	ITPCLK CPU 133M	49.9 1% 1/16W	1	R390	1005	49.9 1% 1/16W	1	R390	1005
19.5M>	IN	-ITPCLK CPU 133M	49.9 1% 1/16W	2	R390	1005	49.9 1% 1/16W	2	R390	1005
19.4M>	IN	PCIE CLK MCH	49.9 1% 1/16W	1	R393	1005	49.9 1% 1/16W	1	R393	1005
19.4M>	IN	-PCIE CLK MCH	49.9 1% 1/16W	2	R393	1005	49.9 1% 1/16W	2	R393	1005
19.4M>	IN	PCIE CLK GFX	49.9 1% 1/16W	1	R478	1005	49.9 1% 1/16W	1	R478	1005
19.4M>	IN	-PCIE CLK GFX	49.9 1% 1/16W	2	R478	1005	49.9 1% 1/16W	2	R478	1005
19.3M>	IN	PCIE CLK ICH6M	49.9 1% 1/16W	1	R409	1005	49.9 1% 1/16W	1	R409	1005
19.3M>	IN	-PCIE CLK ICH6M	49.9 1% 1/16W	2	R409	1005	49.9 1% 1/16W	2	R409	1005
19.3M>	IN	PCIE CLK GBE	49.9 1% 1/16W	1	R411	1005	49.9 1% 1/16W	1	R411	1005
19.3M>	IN	-PCIE CLK GBE	49.9 1% 1/16W	2	R411	1005	49.9 1% 1/16W	2	R411	1005
19.3M>	IN	SATA CLK ICH6M	49.9 1% 1/16W	1	R485	1005	49.9 1% 1/16W	1	R485	1005
19.3M>	IN	-SATA CLK ICH6M	49.9 1% 1/16W	2	R485	1005	49.9 1% 1/16W	2	R485	1005
19.2M>	IN	PCIE CLK EXC	49.9 1% 1/16W	1	R487	1005	49.9 1% 1/16W	1	R487	1005
19.2M>	IN	-PCIE CLK EXC	49.9 1% 1/16W	2	R487	1005	49.9 1% 1/16W	2	R487	1005

BSEL0	BSEL1	FSC	FSB	FSA	CPU
1	0	1			100M
0	0	1			133M
0	1	1			166M

DESIGNER	Y.I	DEC/07/04	PART NO.	39T0167	IBM
CHECKED	Y.Y	DEC/07/04	TITLE	ROME-4 SVT-R(V0.91)	
APPROVED	T.S	DEC/07/04	CLASS	CLOCK GEN(CK410M)	
THIS DOCUMENT IS THE PROPERTY OF IBM ITS USE IS AUTHORIZED ONLY FOR RESPONDING TO A REQUEST FOR QUOTATION OR FOR THE PERFORMANCE OF WORK FOR IBM. ALL QUESTIONS MUST BE REFERRED TO THE IBM PURCHASING DEPARTMENT.					IBM CONFIDENTIAL

39T0167

DATE	EC NO.	PART NO.	
REL DEC/07/04	J79495	39T0167	
		DEVELOPMENT NO.	Q/M
			20 / 88

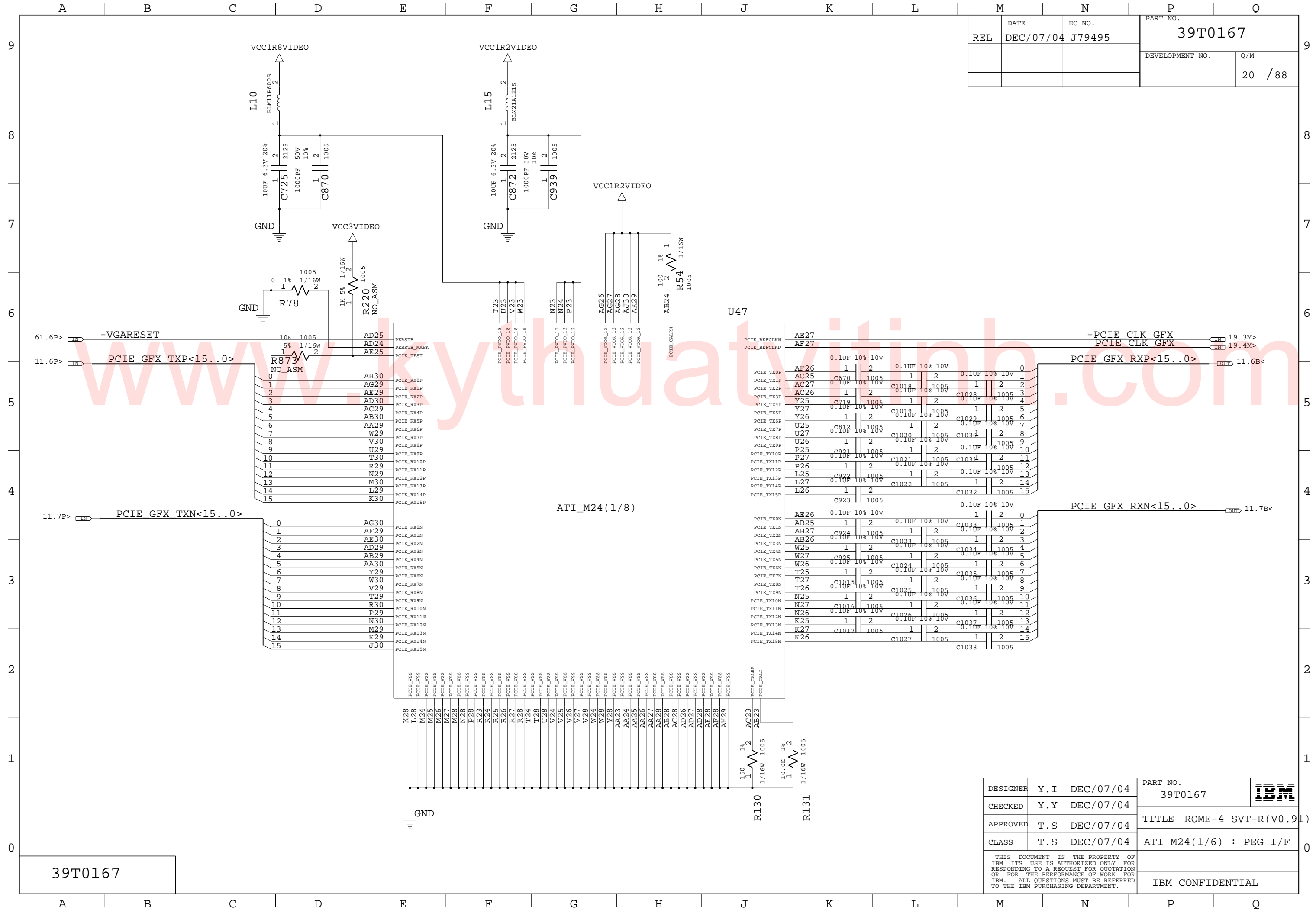

39T0167

DESIGNER	Y.I	DEC/07/04	PART NO.	39T0167	
CHECKED	Y.Y	DEC/07/04			
APPROVED	T.S	DEC/07/04	TITLE	ROME-4 SVT-R(V0.91)	
CLASS	T.S	DEC/07/04		ATI M24(1/6) : PEG I/F	
THIS DOCUMENT IS THE PROPERTY OF IBM. ITS USE IS AUTHORIZED ONLY FOR RESPONDING TO A REQUEST FOR QUOTATION OR FOR THE PERFORMANCE OF WORK FOR IBM. ALL QUESTIONS MUST BE REFERRED TO THE IBM PURCHASING DEPARTMENT.				IBM CONFIDENTIAL	

DATE	EC NO.	PART NO.
REL DEC/07/04	J79495	39T0167
DEVELOPMENT NO.		Q/M
		21 / 88

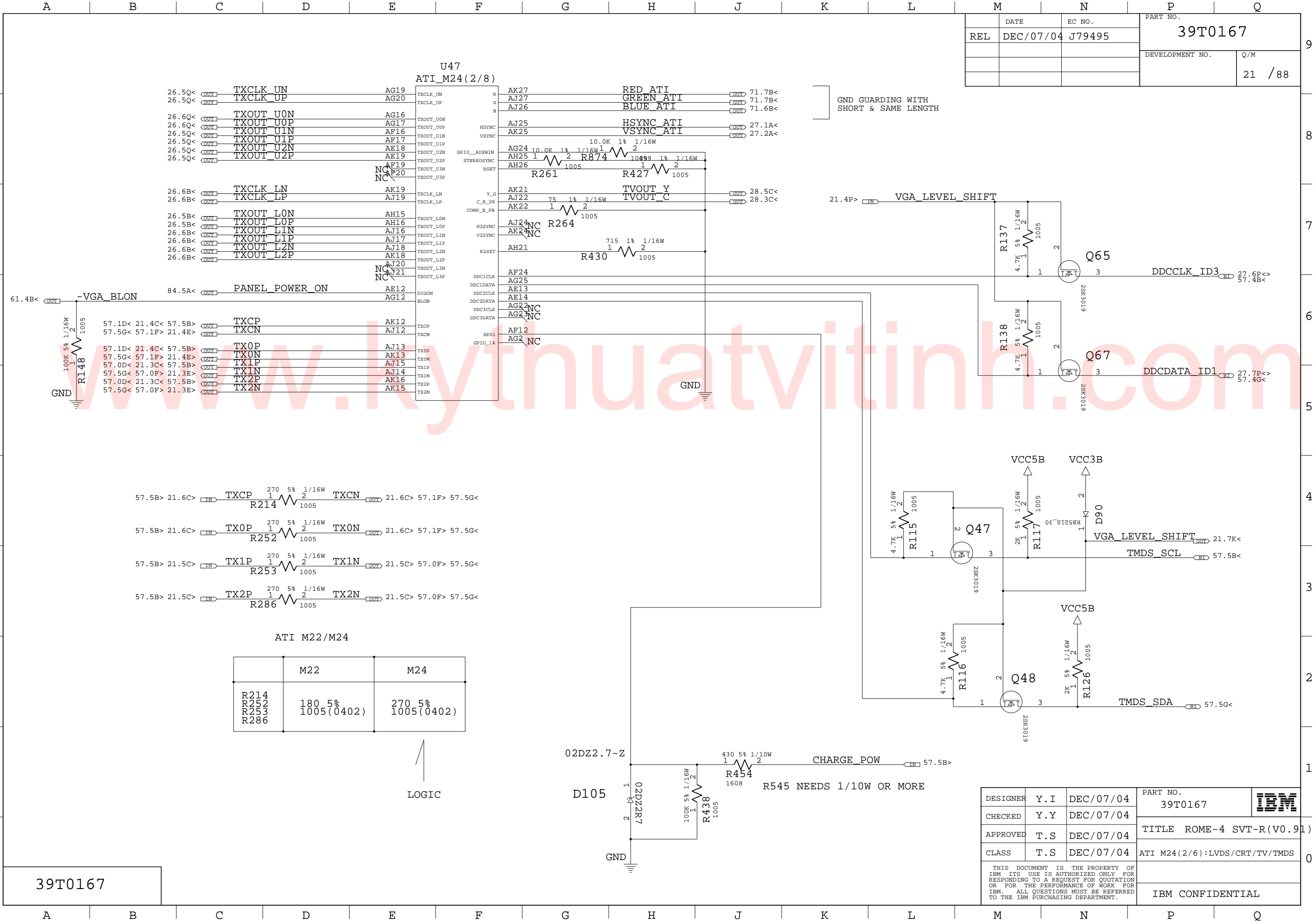

ATI M22/M24

	M22	M24
R214		
R252	180 5%	270 5%
R253	1005(0402)	1005(0402)
R286		

DESIGNER	Y.I	DEC/07/04	PART NO.	39T0167	IBM
CHECKED	Y.Y	DEC/07/04			
APPROVED	T.S	DEC/07/04	TITLE ROME-4 SVT-R(V0.91)		
CLASS	T.S	DEC/07/04	ATI M24(2/6):LVDS/CRT/TV/TMDS		
THIS DOCUMENT IS THE PROPERTY OF IBM. ITS USE IS AUTHORIZED ONLY FOR RESPONDING TO A REQUEST FOR QUOTATION OR FOR THE PERFORMANCE OF WORK FOR IBM. ALL QUESTIONS MUST BE REFERRED TO THE IBM PURCHASING DEPARTMENT.					IBM CONFIDENTIAL

39T0167

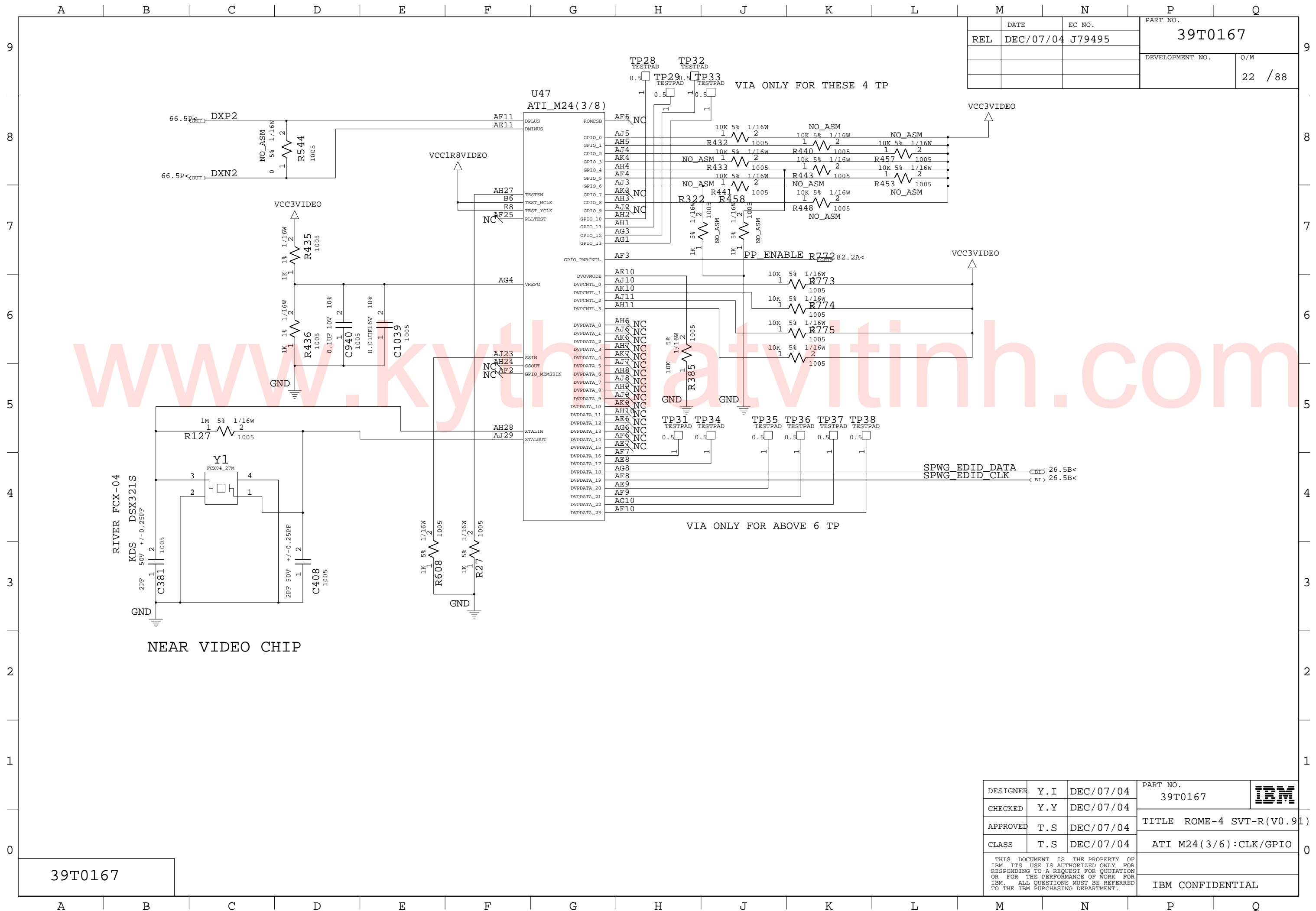

DATE	EC NO.	PART NO.
REL DEC/07/04	J79495	39T0167
DEVELOPMENT NO.		Q/M
		22 / 88

DESIGNER	Y.I	DEC/07/04	PART NO.	39T0167	IBM
CHECKED	Y.Y	DEC/07/04			
APPROVED	T.S	DEC/07/04	TITLE ROME-4 SVT-R(V0.91)		
CLASS	T.S	DEC/07/04	ATI M24(3/6):CLK/GPIO		
THIS DOCUMENT IS THE PROPERTY OF IBM ITS USE IS AUTHORIZED ONLY FOR RESPONDING TO A REQUEST FOR QUOTATION OR FOR THE PERFORMANCE OF WORK FOR IBM. ALL QUESTIONS MUST BE REFERRED TO THE IBM PURCHASING DEPARTMENT.				IBM CONFIDENTIAL	

39T0167

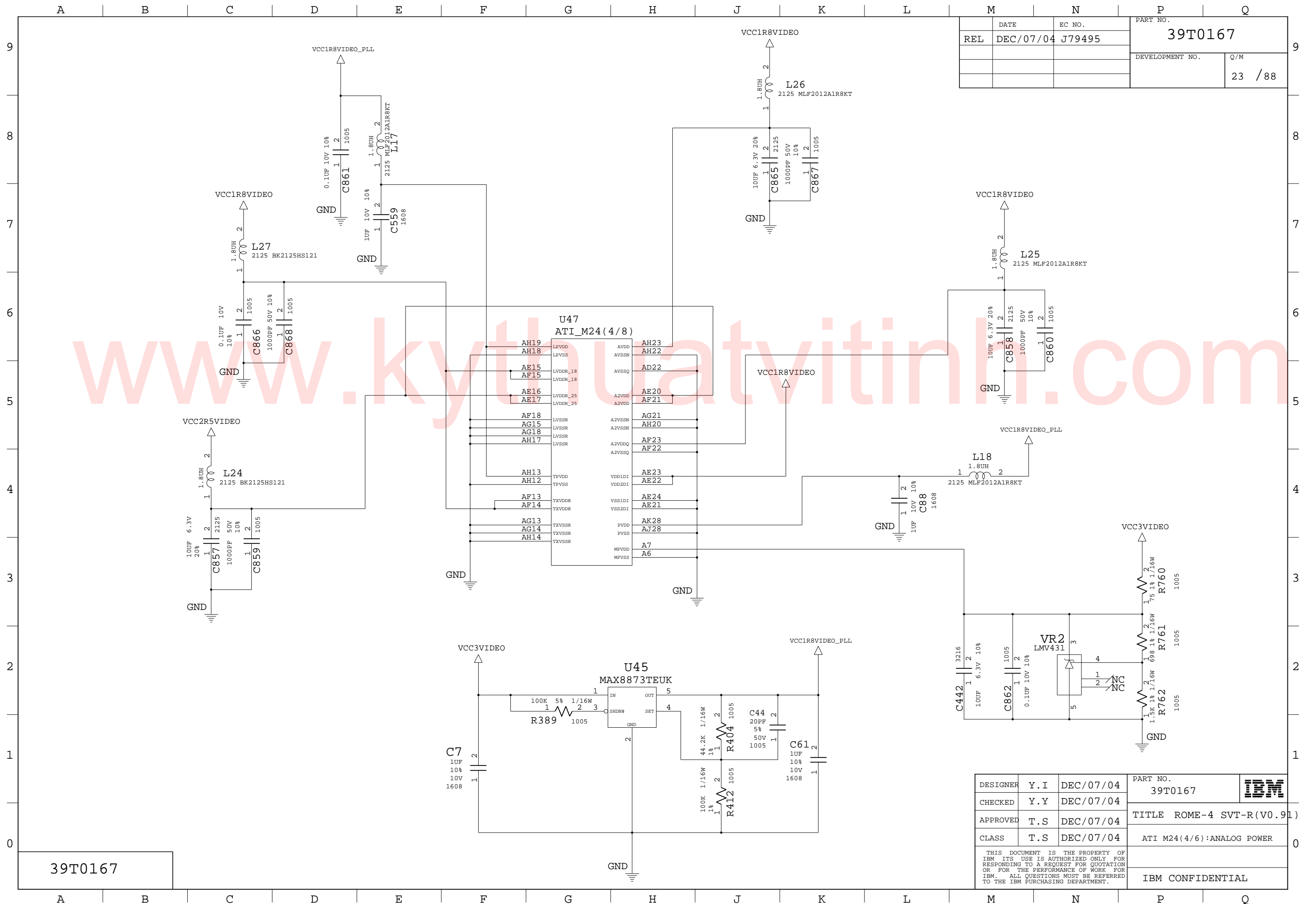

REL	DATE	EC NO.	PART NO.
	DEC/07/04	J79495	39T0167
			DEVELOPMENT NO.
			Q/M
			23 / 88

39T0167

DESIGNER	Y. I	DEC/07/04	PART NO.	39T0167	IBM
CHECKED	Y. Y	DEC/07/04			
APPROVED	T. S	DEC/07/04	TITLE	ROME-4 SVT-R (V0.91)	
CLASS	T. S	DEC/07/04		ATI M24(4/6):ANALOG POWER	
THIS DOCUMENT IS THE PROPERTY OF IBM. ITS USE IS AUTHORIZED ONLY FOR RESPONDING TO A REQUEST FOR QUOTATION OR FOR THE PERFORMANCE OF WORK FOR IBM. ALL QUESTIONS MUST BE REFERRED TO THE IBM PURCHASING DEPARTMENT.				IBM CONFIDENTIAL	

	DATE	EC NO.	PART NO.
REL	DEC/07/04	J79495	39T0167
			DEVELOPMENT NO.
			Q/M
			24 / 88

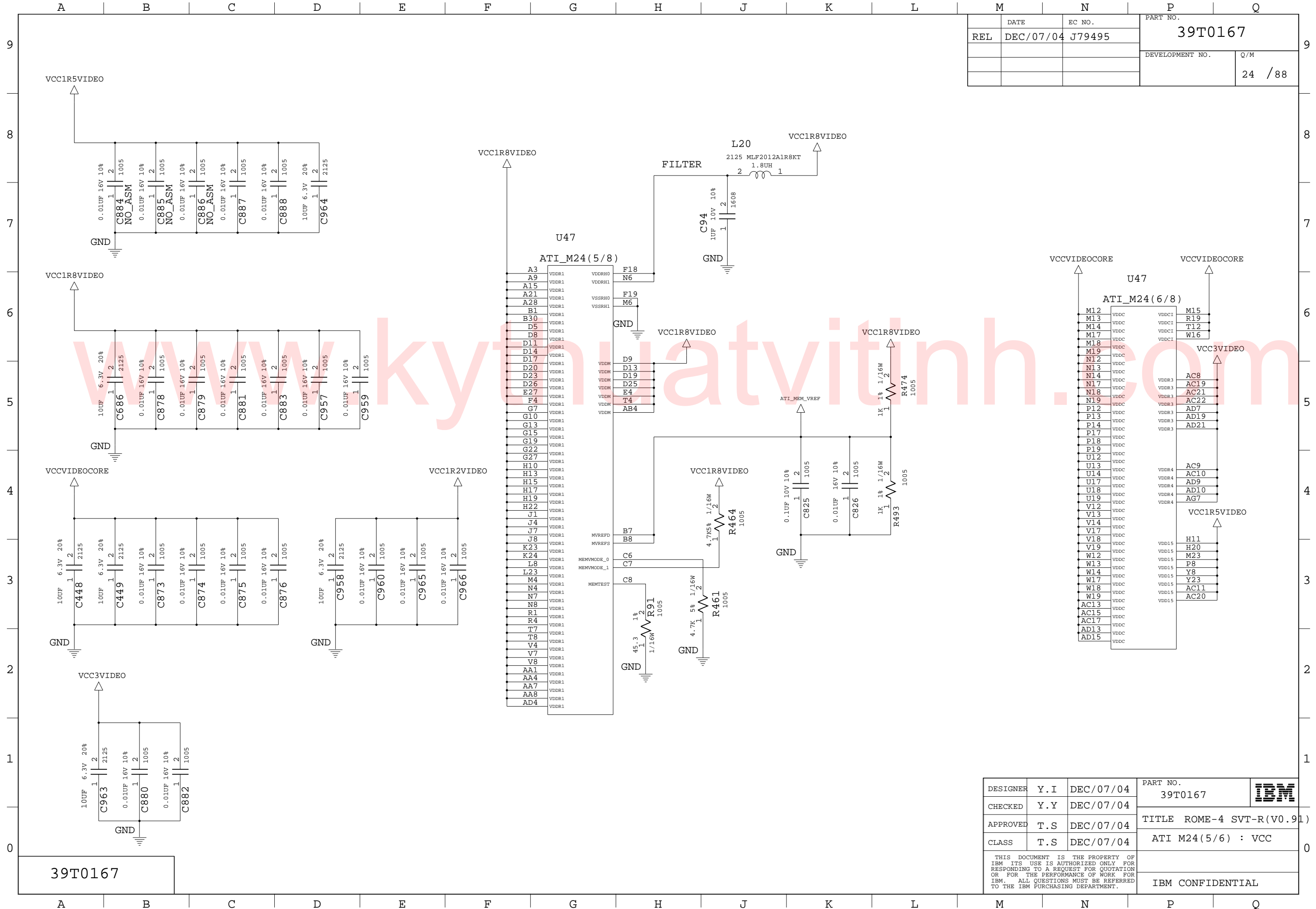

39T0167

DESIGNER	Y. I	DEC/07/04	PART NO.	39T0167	
CHECKED	Y. Y	DEC/07/04			
APPROVED	T. S	DEC/07/04	TITLE ROME-4 SVT-R (V0.91)		
CLASS	T. S	DEC/07/04	ATI M24 (5/6) : VCC		
THIS DOCUMENT IS THE PROPERTY OF IBM. ITS USE IS AUTHORIZED ONLY FOR RESPONDING TO A REQUEST FOR QUOTATION OR FOR THE PERFORMANCE OF WORK FOR IBM. ALL QUESTIONS MUST BE REFERRED TO THE IBM PURCHASING DEPARTMENT.					IBM CONFIDENTIAL

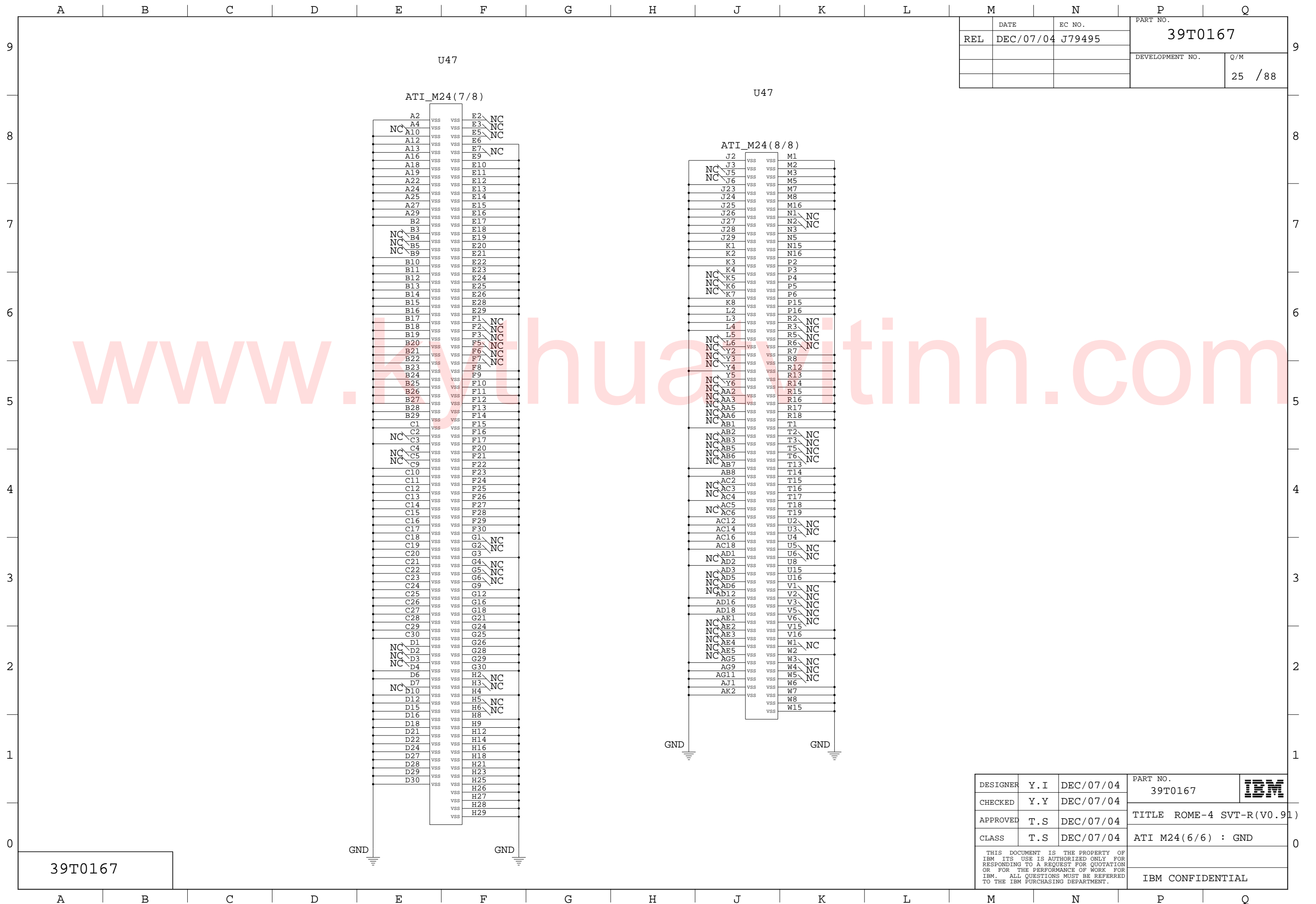

	DATE	EC NO.	PART NO.
REL	DEC/07/04	J79495	39T0167
			DEVELOPMENT NO.
			Q/M
			25 / 88

39T0167

DESIGNER	Y. I	DEC/07/04	PART NO.	39T0167	IBM
CHECKED	Y. Y	DEC/07/04			
APPROVED	T. S	DEC/07/04	TITLE ROME-4 SVT-R (V0.91)		
CLASS	T. S	DEC/07/04	ATI M24(6/6) : GND		
THIS DOCUMENT IS THE PROPERTY OF IBM. ITS USE IS AUTHORIZED ONLY FOR RESPONDING TO A REQUEST FOR QUOTATION OR FOR THE PERFORMANCE OF WORK FOR IBM. ALL QUESTIONS MUST BE REFERRED TO THE IBM PURCHASING DEPARTMENT.				IBM CONFIDENTIAL	

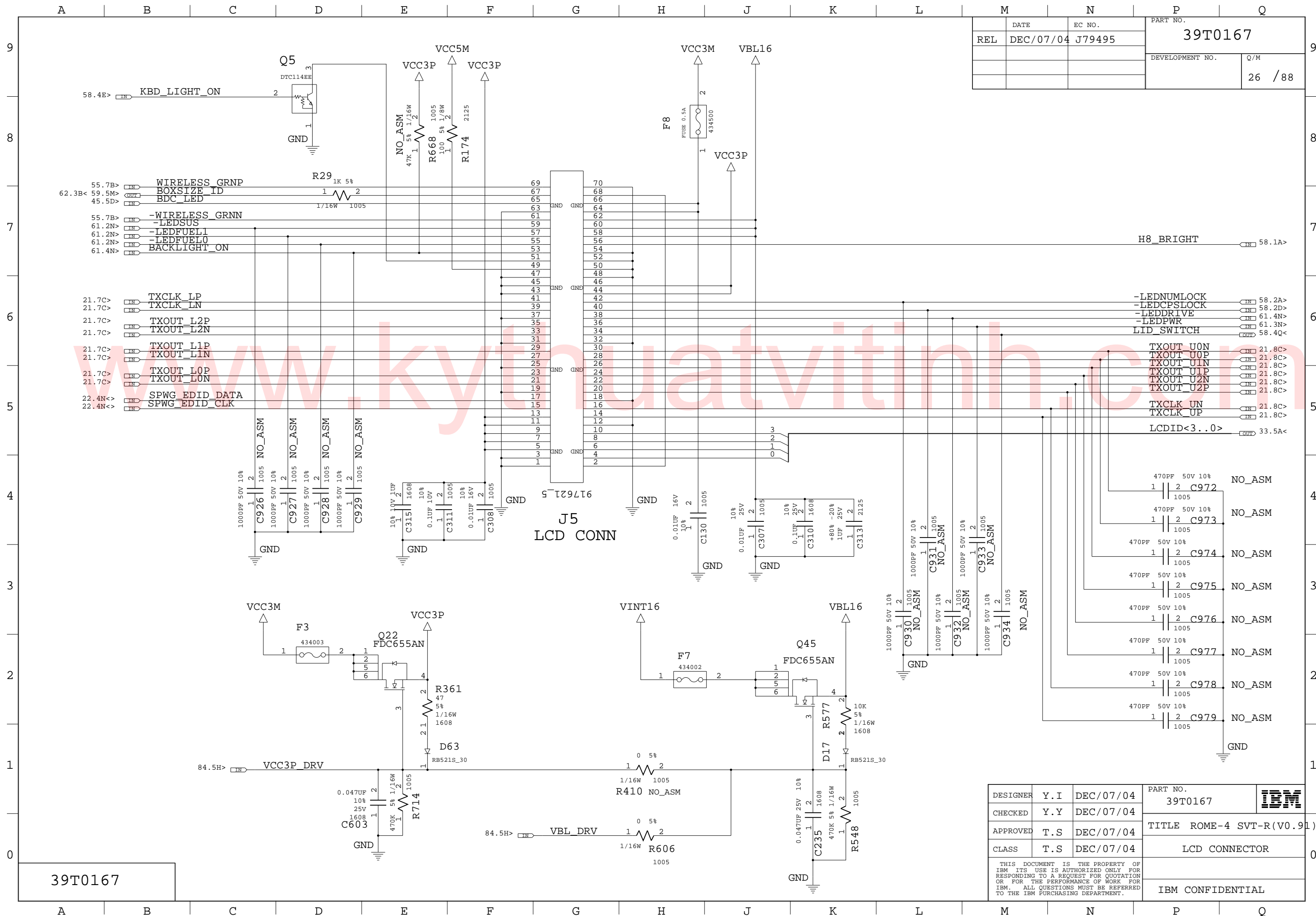

REL	DATE	EC NO.	PART NO.
	DEC/07/04	J79495	39T0167
			DEVELOPMENT NO.
			Q/M
			26 / 88

39T0167

DESIGNER	Y.I	DEC/07/04	PART NO.	39T0167	IBM
CHECKED	Y.Y	DEC/07/04			
APPROVED	T.S	DEC/07/04	TITLE ROME-4 SVT-R(V0.91)		
CLASS	T.S	DEC/07/04	LCD CONNECTOR		
THIS DOCUMENT IS THE PROPERTY OF IBM. ITS USE IS AUTHORIZED ONLY FOR RESPONDING TO A REQUEST FOR QUOTATION OR FOR THE PERFORMANCE OF WORK FOR IBM. ALL QUESTIONS MUST BE REFERRED TO THE IBM PURCHASING DEPARTMENT.					IBM CONFIDENTIAL

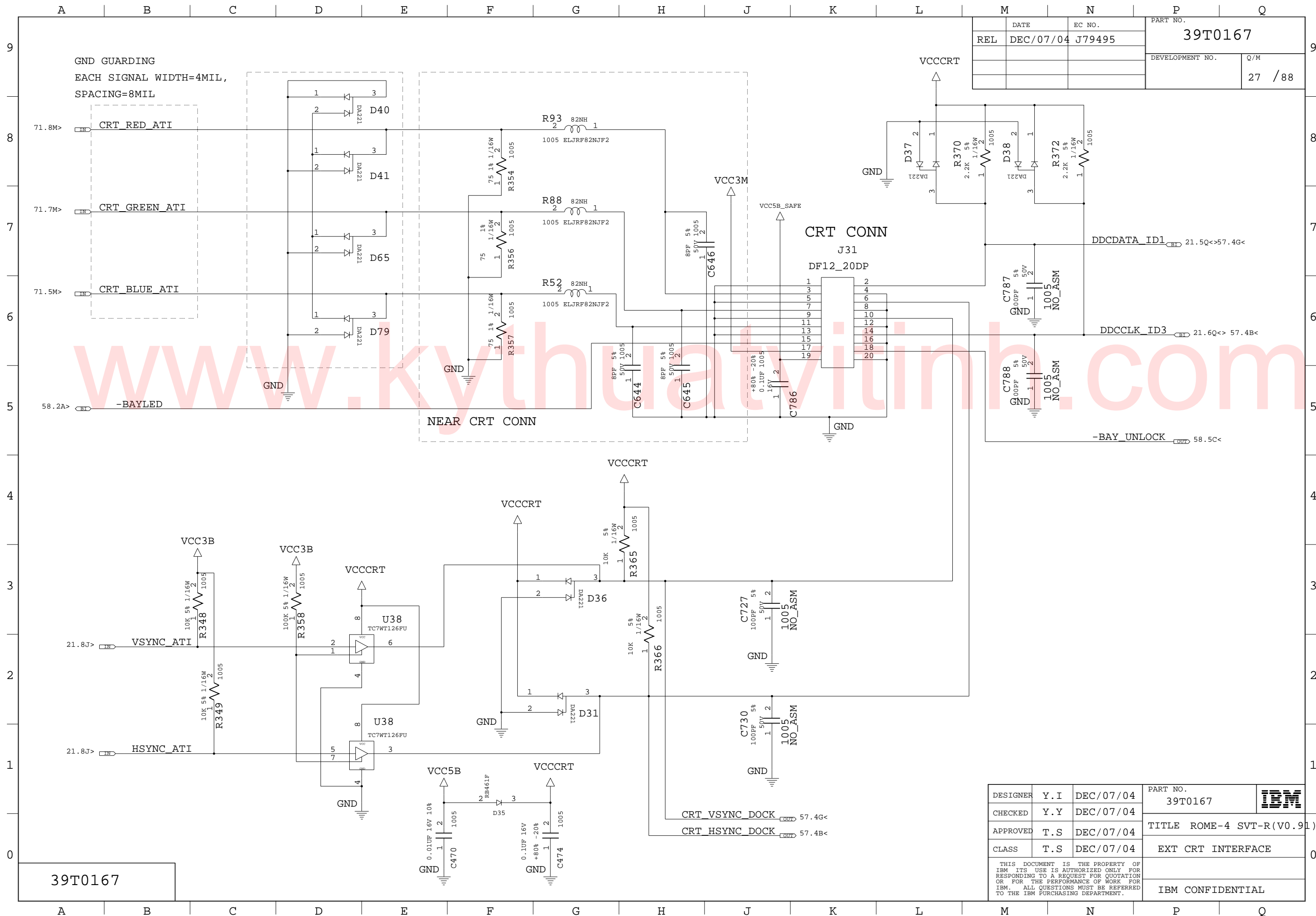

DATE	EC NO.	PART NO.
REL DEC/07/04	J79495	39T0167
DEVELOPMENT NO.		Q/M
		27 / 88

39T0167

DESIGNER	Y.I	DEC/07/04	PART NO.	39T0167	IBM
CHECKED	Y.Y	DEC/07/04			
APPROVED	T.S	DEC/07/04	TITLE ROME-4 SVT-R(V0.91)		
CLASS	T.S	DEC/07/04	EXT CRT INTERFACE		
THIS DOCUMENT IS THE PROPERTY OF IBM. ITS USE IS AUTHORIZED ONLY FOR RESPONDING TO A REQUEST FOR QUOTATION OR FOR THE PERFORMANCE OF WORK FOR IBM. ALL QUESTIONS MUST BE REFERRED TO THE IBM PURCHASING DEPARTMENT.					IBM CONFIDENTIAL

	DATE	EC NO.	PART NO.	
REL	DEC/07/04	J79495	39T0167	
			DEVELOPMENT NO.	Q/M
				28 / 88

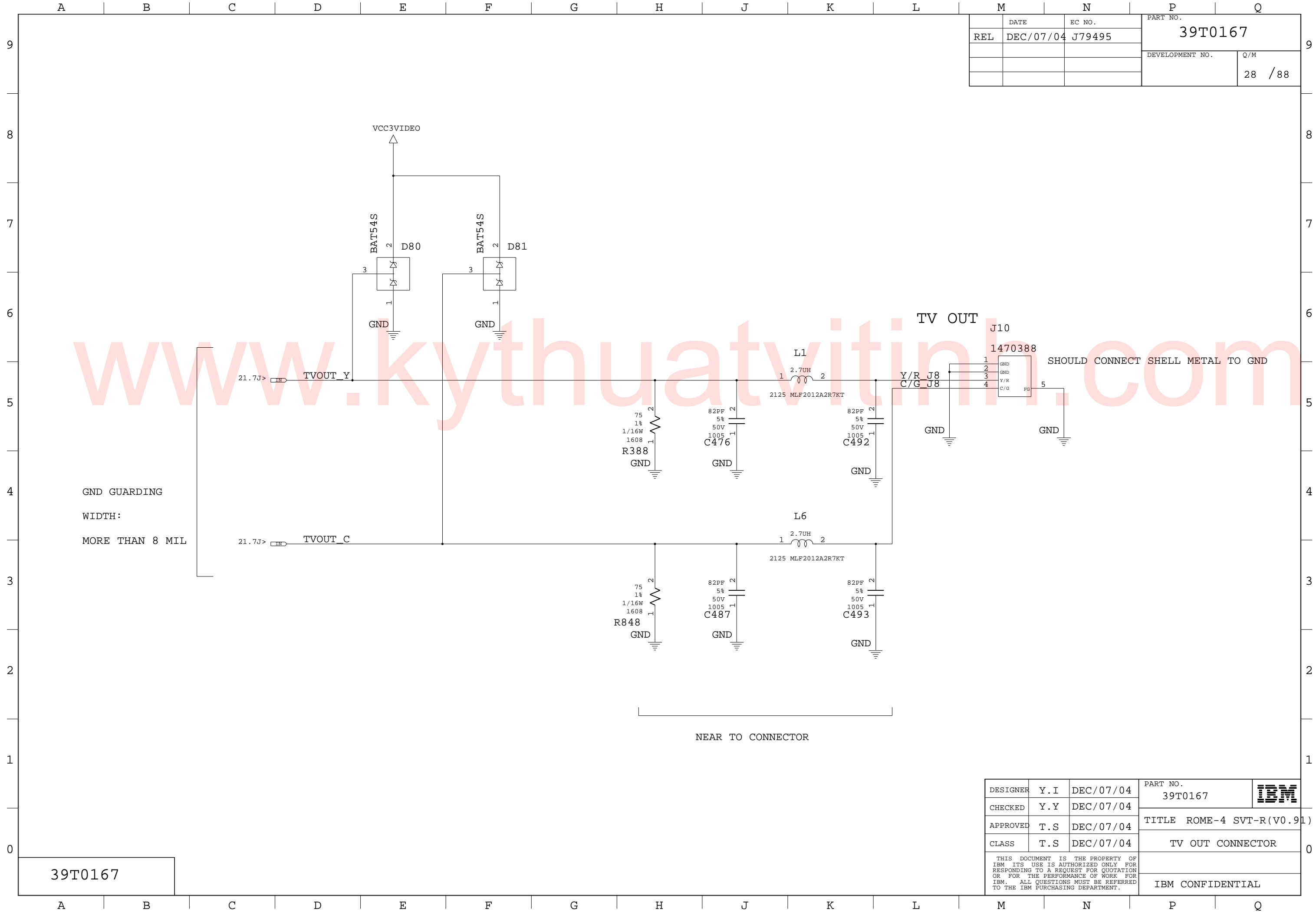

GND GUARDING
WIDTH:
MORE THAN 8 MIL

NEAR TO CONNECTOR

DESIGNER	Y.I	DEC/07/04	PART NO.	39T0167	IBM
CHECKED	Y.Y	DEC/07/04			
APPROVED	T.S	DEC/07/04	TITLE ROME-4 SVT-R(V0.91)		
CLASS	T.S	DEC/07/04	TV OUT CONNECTOR		
THIS DOCUMENT IS THE PROPERTY OF IBM ITS USE IS AUTHORIZED ONLY FOR RESPONDING TO A REQUEST FOR QUOTATION OR FOR THE PERFORMANCE OF WORK FOR IBM. ALL QUESTIONS MUST BE REFERRED TO THE IBM PURCHASING DEPARTMENT.				IBM CONFIDENTIAL	

39T0167

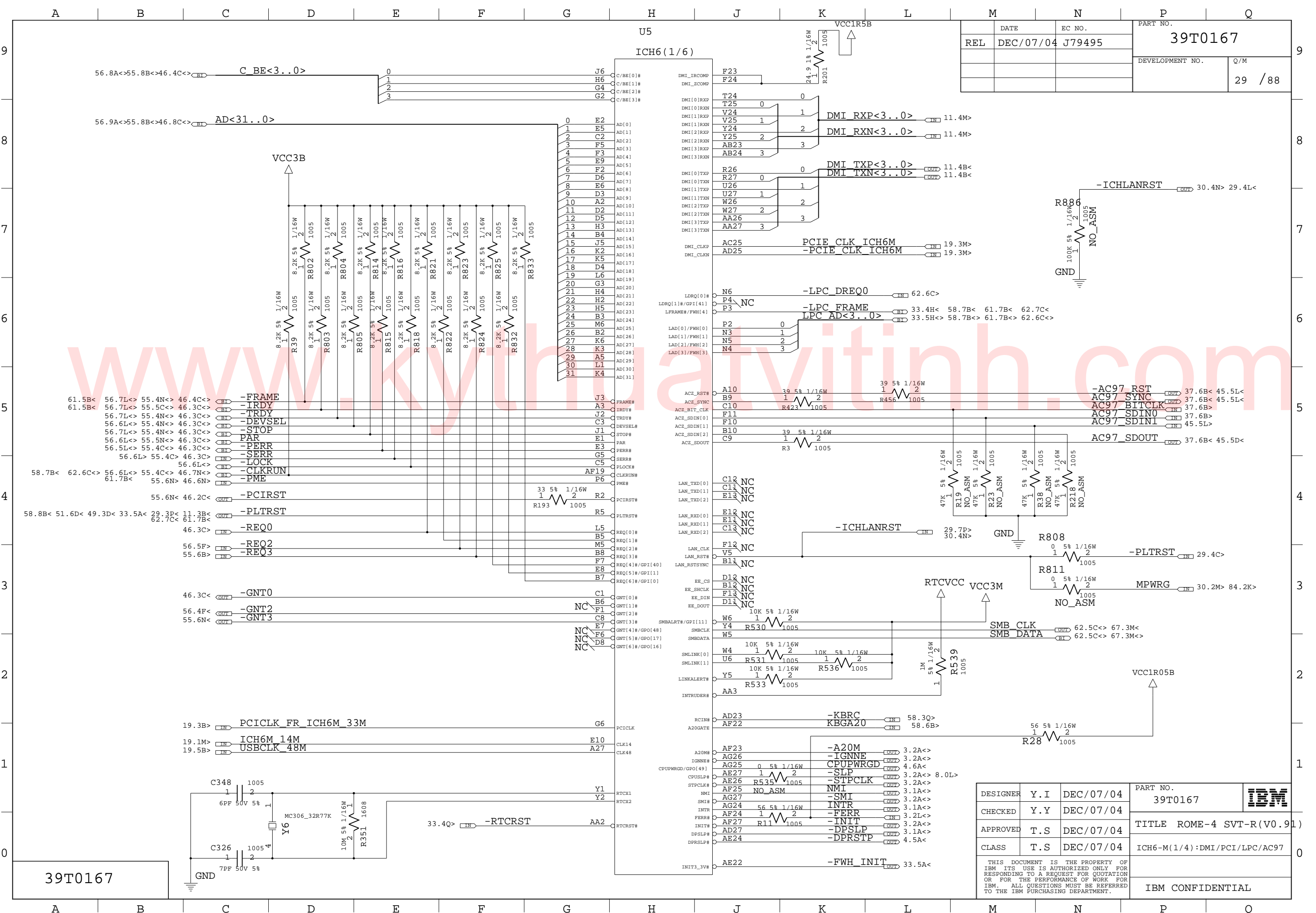

REL	DATE	EC NO.	PART NO.
	DEC/07/04	J79495	39T0167
			DEVELOPMENT NO.
			Q/M
			29 / 88

DESIGNER	Y.I	DEC/07/04	PART NO.	39T0167	IBM
CHECKED	Y.Y	DEC/07/04			
APPROVED	T.S	DEC/07/04	TITLE	ROME-4 SVT-R(V0.91)	
CLASS	T.S	DEC/07/04	ICH6-M(1/4):DMI/PCI/LPC/AC97		
THIS DOCUMENT IS THE PROPERTY OF IBM. ITS USE IS AUTHORIZED ONLY FOR RESPONDING TO A REQUEST FOR QUOTATION OR FOR THE PERFORMANCE OF WORK FOR IBM. ALL QUESTIONS MUST BE REFERRED TO THE IBM PURCHASING DEPARTMENT.				IBM CONFIDENTIAL	

39T0167

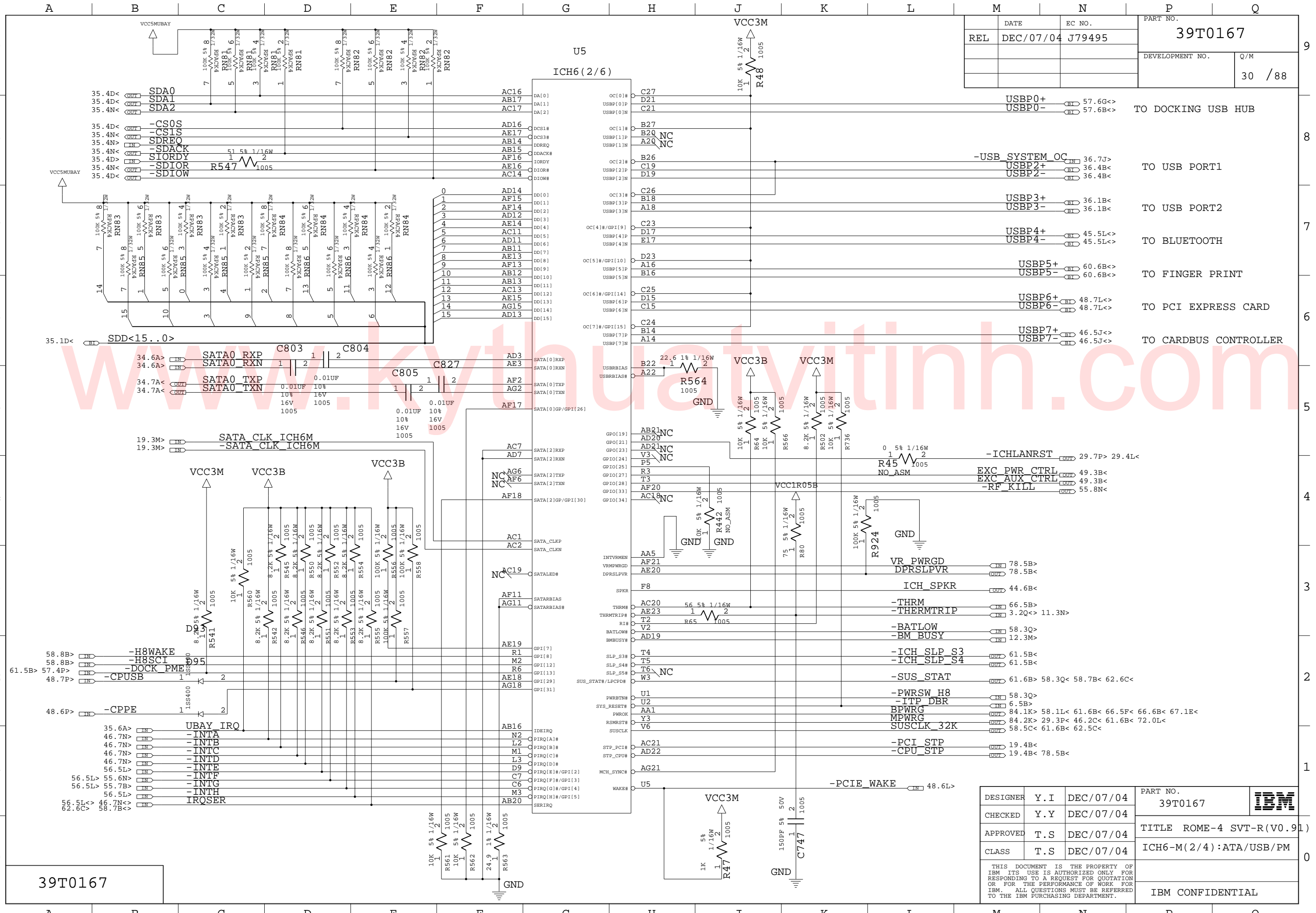

DATE	EC NO.	PART NO.
REL DEC/07/04	J79495	39T0167
DEVELOPMENT NO.		Q/M
		30 / 88

39T0167

DESIGNER	Y.I	DEC/07/04	PART NO.	39T0167	
CHECKED	Y.Y	DEC/07/04	TITLE ROME-4 SVT-R(V0.91)		
APPROVED	T.S	DEC/07/04	ICH6-M(2/4):ATA/USB/PM		
CLASS	T.S	DEC/07/04			
THIS DOCUMENT IS THE PROPERTY OF IBM ITS USE IS AUTHORIZED ONLY FOR RESPONDING TO A REQUEST FOR QUOTATION OR FOR THE PERFORMANCE OF WORK FOR IBM. ALL QUESTIONS MUST BE REFERRED TO THE IBM PURCHASING DEPARTMENT.					IBM CONFIDENTIAL

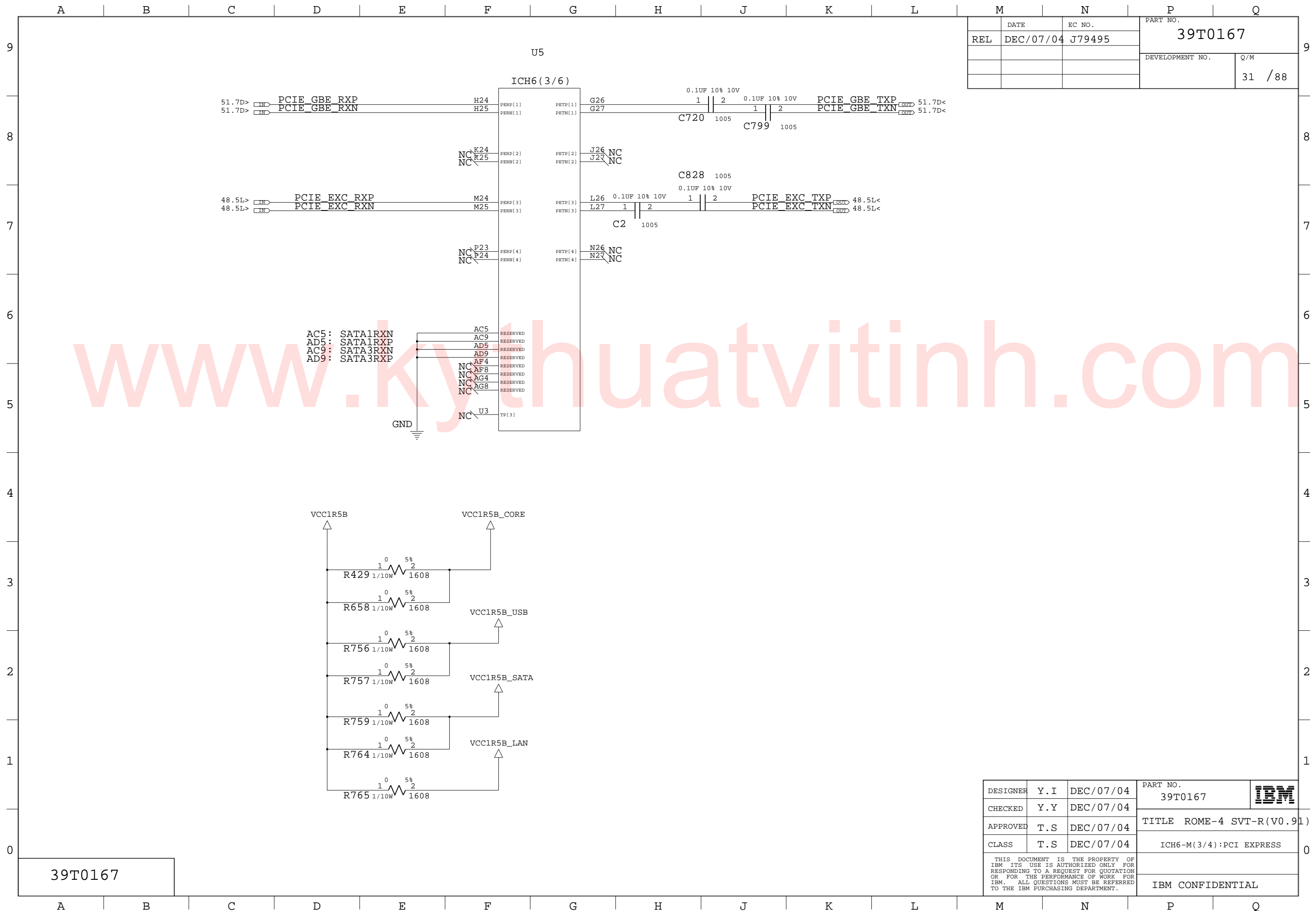

REL	DATE	EC NO.	PART NO.
	DEC/07/04	J79495	39T0167
			DEVELOPMENT NO.
			Q/M
			31 / 88

www.kyathuatvith.com

39T0167

DESIGNER	Y. I	DEC/07/04	PART NO.	39T0167	IBM
CHECKED	Y. Y	DEC/07/04			
APPROVED	T. S	DEC/07/04	TITLE ROME-4 SVT-R (V0.91)		
CLASS	T. S	DEC/07/04	ICH6-M(3/4):PCI EXPRESS		
THIS DOCUMENT IS THE PROPERTY OF IBM. ITS USE IS AUTHORIZED ONLY FOR RESPONDING TO A REQUEST FOR QUOTATION OR FOR THE PERFORMANCE OF WORK FOR IBM. ALL QUESTIONS MUST BE REFERRED TO THE IBM PURCHASING DEPARTMENT.				IBM CONFIDENTIAL	

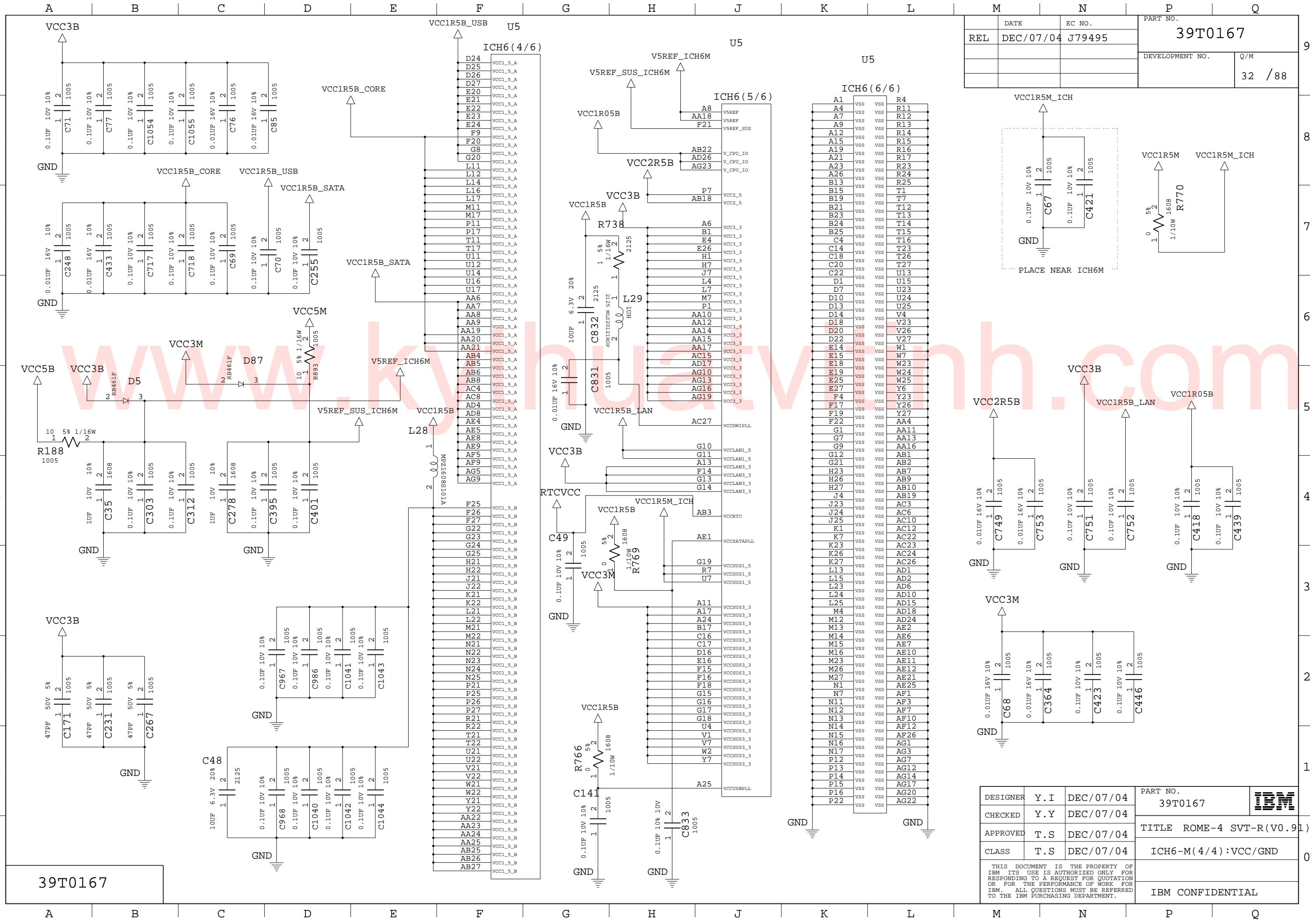

REL	DATE	EC NO.	PART NO.
	DEC/07/04	J79495	39T0167
			DEVELOPMENT NO.
			Q/M
			32 / 88

39T0167

DESIGNER	Y.I	DEC/07/04	PART NO.	39T0167	
CHECKED	Y.Y	DEC/07/04			
APPROVED	T.S	DEC/07/04	TITLE	ROME-4 SVT-R (V0.91)	
CLASS	T.S	DEC/07/04	ICH6-M(4/4):VCC/GND		
THIS DOCUMENT IS THE PROPERTY OF IBM ITS USE IS AUTHORIZED ONLY FOR RESPONDING TO A REQUEST FOR QUOTATION OR FOR THE PERFORMANCE OF WORK FOR IBM. ALL QUESTIONS MUST BE REFERRED TO THE IBM PURCHASING DEPARTMENT.				IBM CONFIDENTIAL	

	DATE	EC NO.	PART NO.	
REL	DEC/07/04	J79495	39T0167	
			DEVELOPMENT NO.	Q/M
				33 / 88

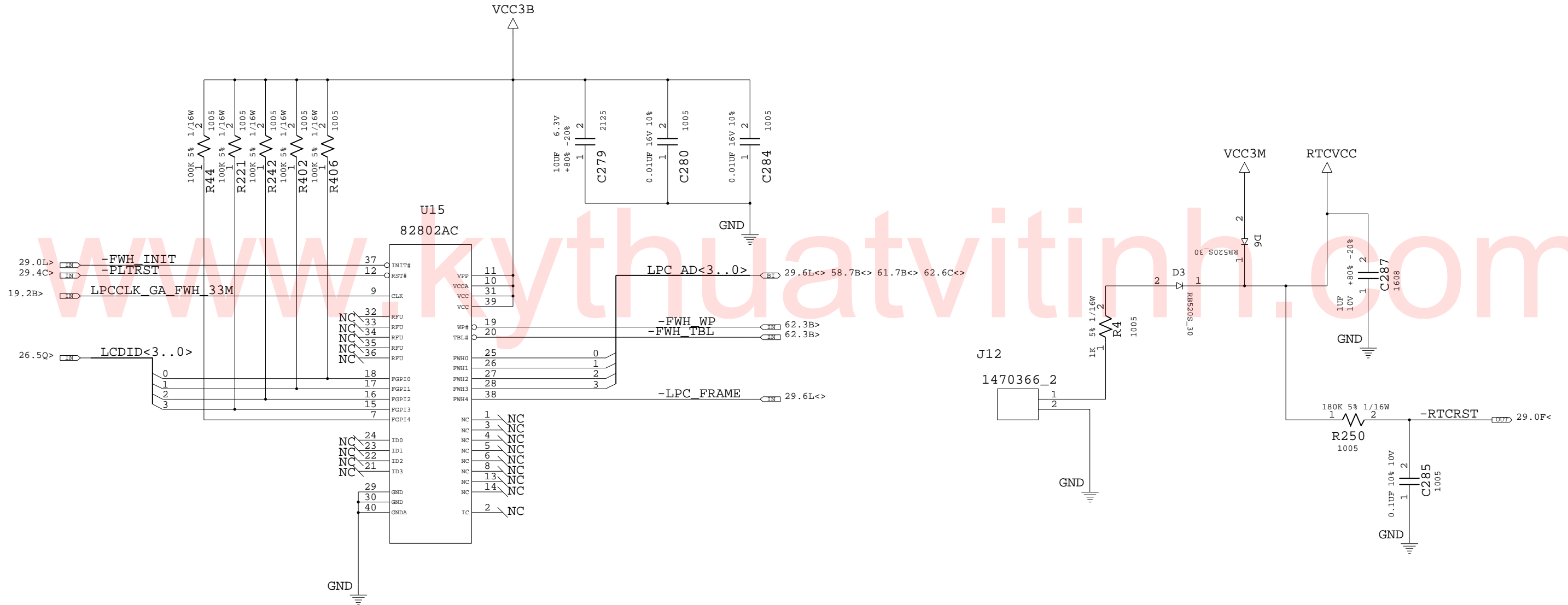

39T0167

DESIGNER	Y. I	DEC/07/04	PART NO.	39T0167	
CHECKED	Y. Y	DEC/07/04			
APPROVED	T. S	DEC/07/04	TITLE ROME-4 SVT-R (V0.91)		
CLASS	T. S	DEC/07/04	FWH, RTC BATTERY		
THIS DOCUMENT IS THE PROPERTY OF IBM ITS USE IS AUTHORIZED ONLY FOR RESPONDING TO A REQUEST FOR QUOTATION OR FOR THE PERFORMANCE OF WORK FOR IBM. ALL QUESTIONS MUST BE REFERRED TO THE IBM PURCHASING DEPARTMENT.				IBM CONFIDENTIAL	

REL	DATE	EC NO.	PART NO.
	DEC/07/04	J79495	39T0167
			DEVELOPMENT NO.
			Q/M
			34 / 88

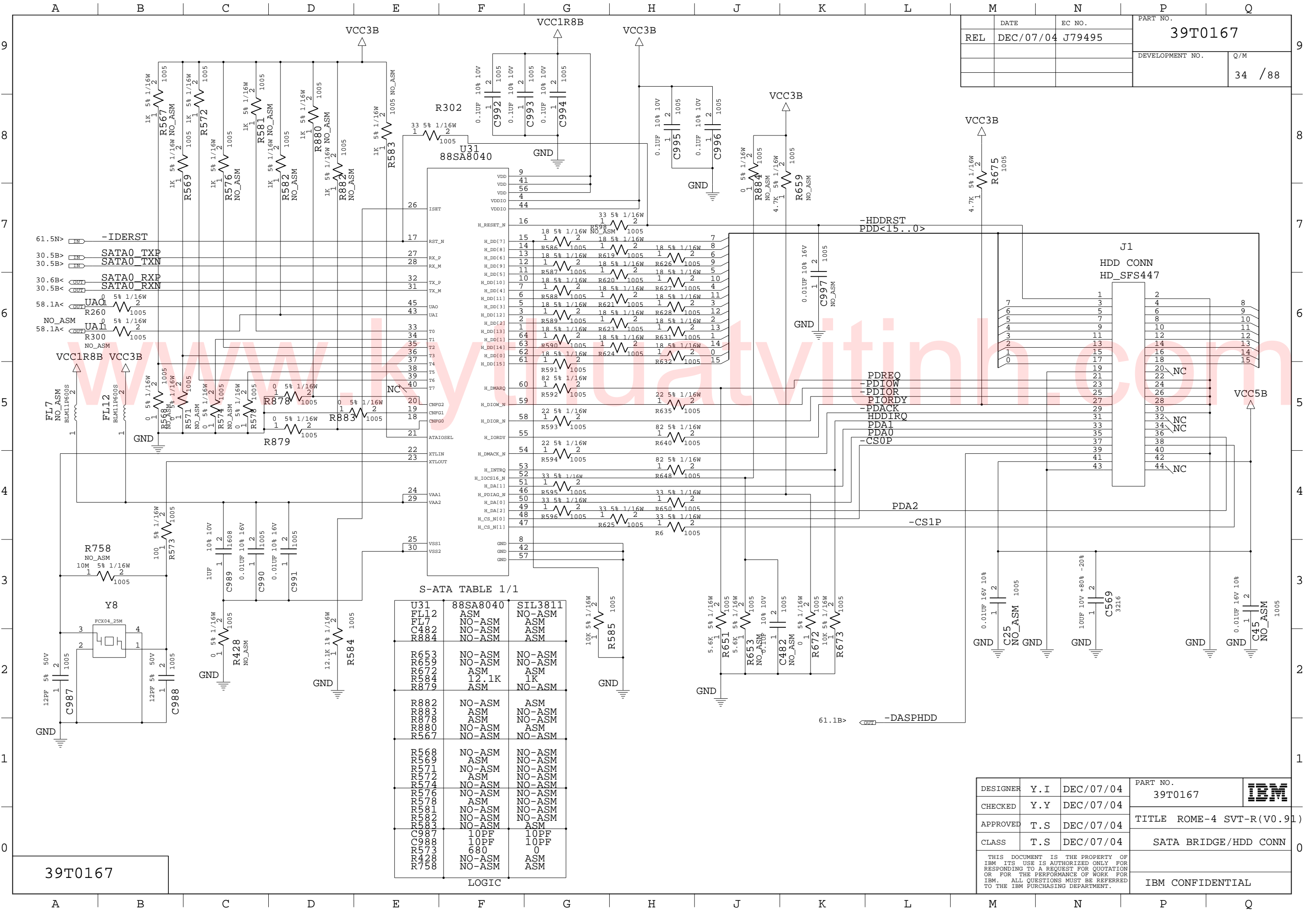

S-ATA TABLE 1/1

U31	88SA8040	SIL3811
FL12	ASM	NO-ASM
FL7	NO-ASM	ASM
C482	NO-ASM	ASM
R884	NO-ASM	ASM
R653	NO-ASM	NO-ASM
R651	NO-ASM	NO-ASM
R652	NO-ASM	NO-ASM
R653	NO-ASM	NO-ASM
R654	NO-ASM	NO-ASM
R655	NO-ASM	NO-ASM
R656	NO-ASM	NO-ASM
R657	NO-ASM	NO-ASM
R658	NO-ASM	NO-ASM
R659	NO-ASM	NO-ASM
R660	NO-ASM	NO-ASM
R661	NO-ASM	NO-ASM
R662	NO-ASM	NO-ASM
R663	NO-ASM	NO-ASM
R664	NO-ASM	NO-ASM
R665	NO-ASM	NO-ASM
R666	NO-ASM	NO-ASM
R667	NO-ASM	NO-ASM
R668	NO-ASM	NO-ASM
R669	NO-ASM	NO-ASM
R670	NO-ASM	NO-ASM
R671	NO-ASM	NO-ASM
R672	NO-ASM	NO-ASM
R673	NO-ASM	NO-ASM
R674	NO-ASM	NO-ASM
R675	NO-ASM	NO-ASM
R676	NO-ASM	NO-ASM
R677	NO-ASM	NO-ASM
R678	NO-ASM	NO-ASM
R679	NO-ASM	NO-ASM
R680	NO-ASM	NO-ASM
R681	NO-ASM	NO-ASM
R682	NO-ASM	NO-ASM
R683	NO-ASM	NO-ASM
R684	NO-ASM	NO-ASM
R685	NO-ASM	NO-ASM
R686	NO-ASM	NO-ASM
R687	NO-ASM	NO-ASM
R688	NO-ASM	NO-ASM
R689	NO-ASM	NO-ASM
R690	NO-ASM	NO-ASM
R691	NO-ASM	NO-ASM
R692	NO-ASM	NO-ASM
R693	NO-ASM	NO-ASM
R694	NO-ASM	NO-ASM
R695	NO-ASM	NO-ASM
R696	NO-ASM	NO-ASM
R697	NO-ASM	NO-ASM
R698	NO-ASM	NO-ASM
R699	NO-ASM	NO-ASM
R700	NO-ASM	NO-ASM
R701	NO-ASM	NO-ASM
R702	NO-ASM	NO-ASM
R703	NO-ASM	NO-ASM
R704	NO-ASM	NO-ASM
R705	NO-ASM	NO-ASM
R706	NO-ASM	NO-ASM
R707	NO-ASM	NO-ASM
R708	NO-ASM	NO-ASM
R709	NO-ASM	NO-ASM
R710	NO-ASM	NO-ASM
R711	NO-ASM	NO-ASM
R712	NO-ASM	NO-ASM
R713	NO-ASM	NO-ASM
R714	NO-ASM	NO-ASM
R715	NO-ASM	NO-ASM
R716	NO-ASM	NO-ASM
R717	NO-ASM	NO-ASM
R718	NO-ASM	NO-ASM
R719	NO-ASM	NO-ASM
R720	NO-ASM	NO-ASM
R721	NO-ASM	NO-ASM
R722	NO-ASM	NO-ASM
R723	NO-ASM	NO-ASM
R724	NO-ASM	NO-ASM
R725	NO-ASM	NO-ASM
R726	NO-ASM	NO-ASM
R727	NO-ASM	NO-ASM
R728	NO-ASM	NO-ASM
R729	NO-ASM	NO-ASM
R730	NO-ASM	NO-ASM
R731	NO-ASM	NO-ASM
R732	NO-ASM	NO-ASM
R733	NO-ASM	NO-ASM
R734	NO-ASM	NO-ASM
R735	NO-ASM	NO-ASM
R736	NO-ASM	NO-ASM
R737	NO-ASM	NO-ASM
R738	NO-ASM	NO-ASM
R739	NO-ASM	NO-ASM
R740	NO-ASM	NO-ASM
R741	NO-ASM	NO-ASM
R742	NO-ASM	NO-ASM
R743	NO-ASM	NO-ASM
R744	NO-ASM	NO-ASM
R745	NO-ASM	NO-ASM
R746	NO-ASM	NO-ASM
R747	NO-ASM	NO-ASM
R748	NO-ASM	NO-ASM
R749	NO-ASM	NO-ASM
R750	NO-ASM	NO-ASM
R751	NO-ASM	NO-ASM
R752	NO-ASM	NO-ASM
R753	NO-ASM	NO-ASM
R754	NO-ASM	NO-ASM
R755	NO-ASM	NO-ASM
R756	NO-ASM	NO-ASM
R757	NO-ASM	NO-ASM
R758	NO-ASM	NO-ASM

DESIGNER	Y.I	DEC/07/04	PART NO.	39T0167	IBM
CHECKED	Y.Y	DEC/07/04			
APPROVED	T.S	DEC/07/04	TITLE ROME-4 SVT-R(V0.91)		
CLASS	T.S	DEC/07/04	SATA BRIDGE/HDD CONN		
THIS DOCUMENT IS THE PROPERTY OF IBM. ITS USE IS AUTHORIZED ONLY FOR RESPONDING TO A REQUEST FOR QUOTATION OR FOR THE PERFORMANCE OF WORK FOR IBM. ALL QUESTIONS MUST BE REFERRED TO THE IBM PURCHASING DEPARTMENT.					IBM CONFIDENTIAL

39T0167

LOGIC

	DATE	EC NO.	PART NO.
REL	DEC/07/04	J79495	39T0167
			DEVELOPMENT NO.
			Q/M
			35 / 88

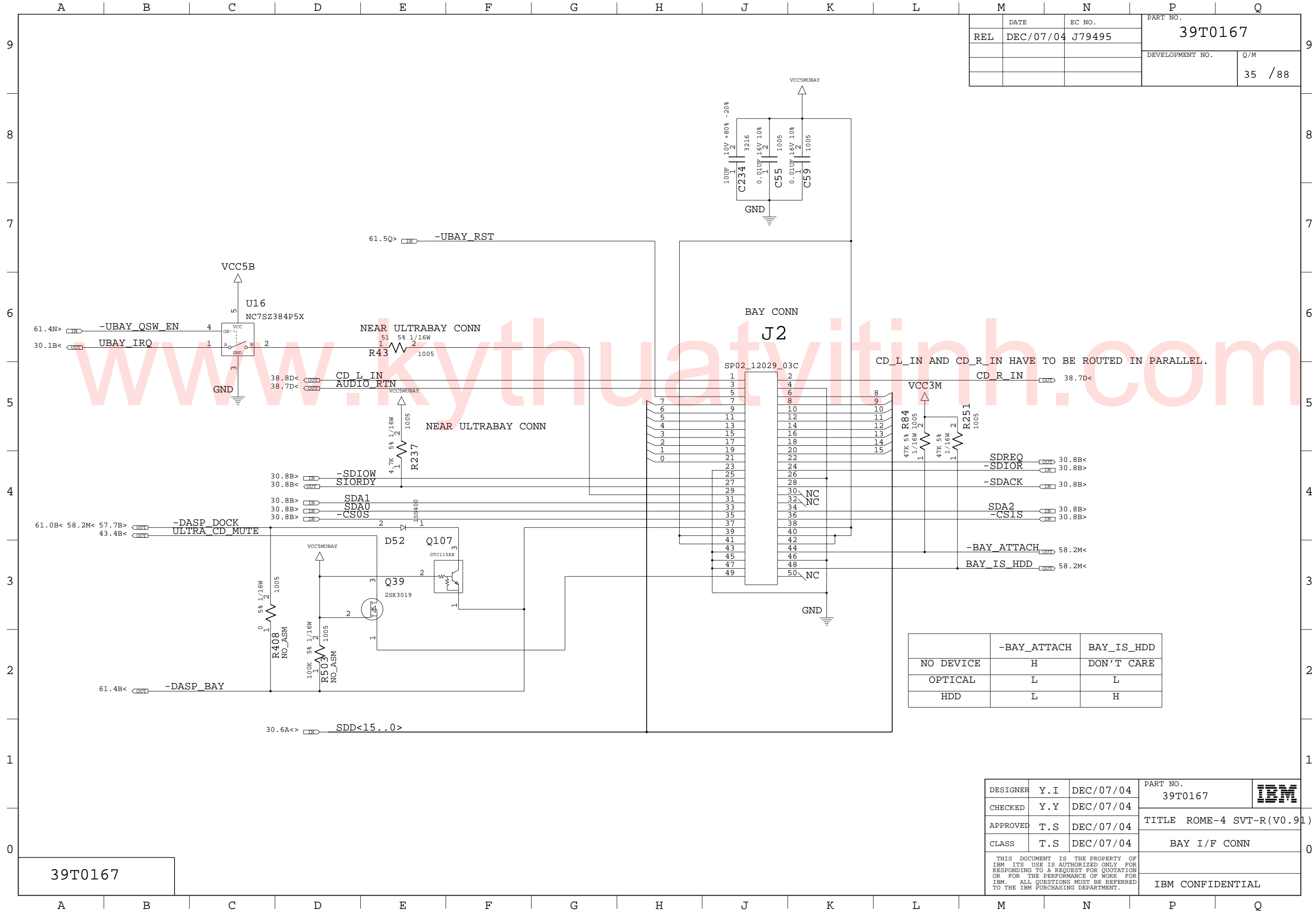

	-BAY_ATTACH	BAY_IS_HDD
NO DEVICE	H	DON'T CARE
OPTICAL	L	L
HDD	L	H

39T0167

DESIGNER	Y.I	DEC/07/04	PART NO.	39T0167	IBM
CHECKED	Y.Y	DEC/07/04			
APPROVED	T.S	DEC/07/04	TITLE ROME-4 SVT-R(V0.91)		
CLASS	T.S	DEC/07/04	BAY I/F CONN		
THIS DOCUMENT IS THE PROPERTY OF IBM ITS USE IS AUTHORIZED ONLY FOR RESPONDING TO A REQUEST FOR QUOTATION OR FOR THE PERFORMANCE OF WORK FOR IBM. ALL QUESTIONS MUST BE REFERRED TO THE IBM PURCHASING DEPARTMENT.					IBM CONFIDENTIAL

	DATE	EC NO.	PART NO.
REL	DEC/07/04	J79495	39T0167
			DEVELOPMENT NO.
			Q/M
			36 / 88

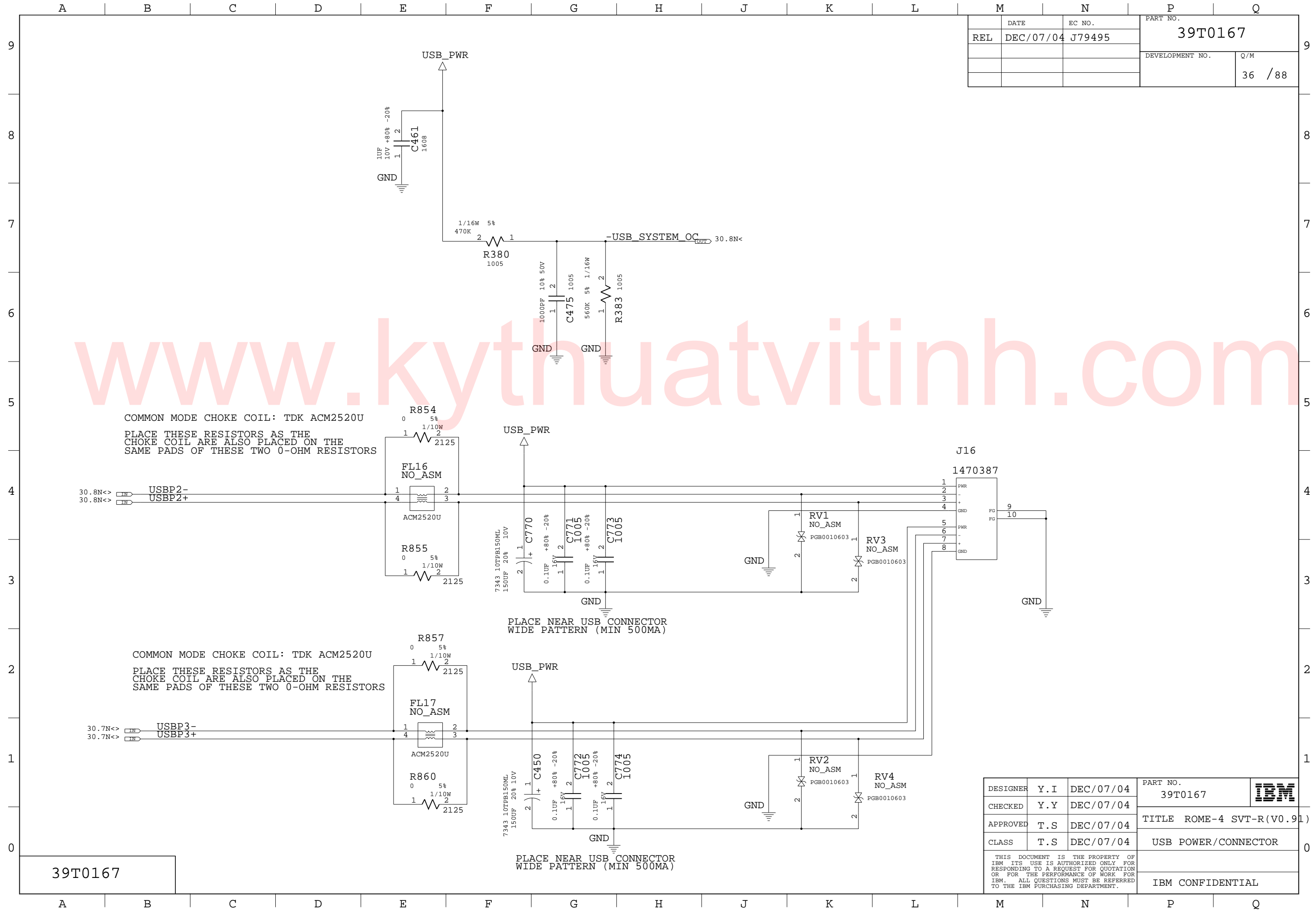

COMMON MODE CHOKE COIL: TDK ACM2520U

PLACE THESE RESISTORS AS THE CHOKE COIL ARE ALSO PLACED ON THE SAME PADS OF THESE TWO 0-OHM RESISTORS

PLACE NEAR USB CONNECTOR WIDE PATTERN (MIN 500MA)

COMMON MODE CHOKE COIL: TDK ACM2520U

PLACE THESE RESISTORS AS THE CHOKE COIL ARE ALSO PLACED ON THE SAME PADS OF THESE TWO 0-OHM RESISTORS

PLACE NEAR USB CONNECTOR WIDE PATTERN (MIN 500MA)

39T0167

DESIGNER	Y.I	DEC/07/04	PART NO.	39T0167	
CHECKED	Y.Y	DEC/07/04			
APPROVED	T.S	DEC/07/04	TITLE ROME-4 SVT-R(V0.91)		
CLASS	T.S	DEC/07/04	USB POWER/CONNECTOR		
THIS DOCUMENT IS THE PROPERTY OF IBM ITS USE IS AUTHORIZED ONLY FOR RESPONDING TO A REQUEST FOR QUOTATION OR FOR THE PERFORMANCE OF WORK FOR IBM. ALL QUESTIONS MUST BE REFERRED TO THE IBM PURCHASING DEPARTMENT.				IBM CONFIDENTIAL	

DATE	EC NO.	PART NO.
REL DEC/07/04	J79495	39T0167
		DEVELOPMENT NO.
		Q/M
		37 / 88

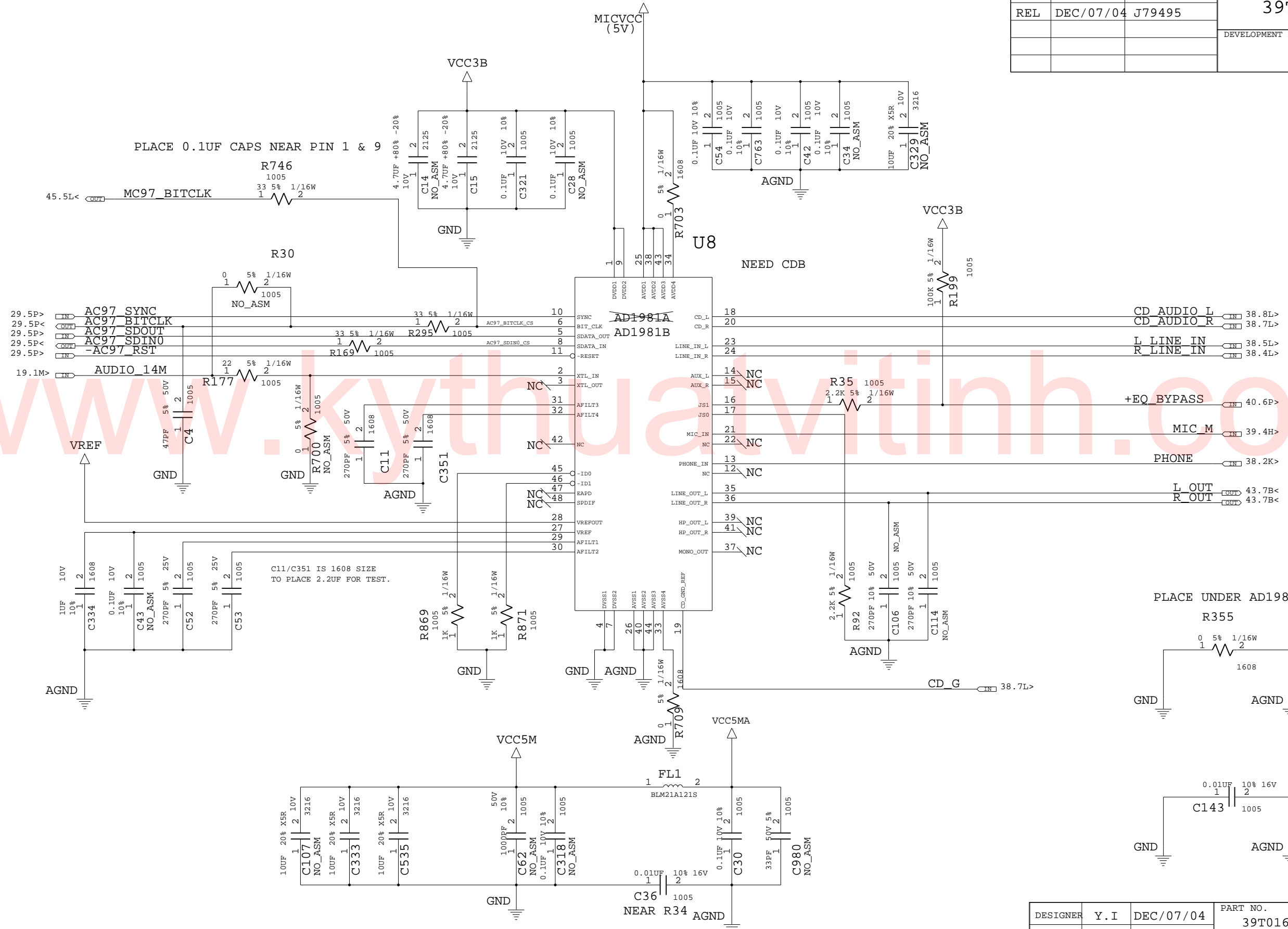

39T0167

DESIGNER	Y.I	DEC/07/04	PART NO.	39T0167	IBM
CHECKED	Y.Y	DEC/07/04			
APPROVED	T.S	DEC/07/04	TITLE ROME-4 SVT-R(V0.91)		
CLASS	T.S	DEC/07/04	AUDIO AD1981B		
THIS DOCUMENT IS THE PROPERTY OF IBM ITS USE IS AUTHORIZED ONLY FOR RESPONDING TO A REQUEST FOR QUOTATION OR FOR THE PERFORMANCE OF WORK FOR IBM. ALL QUESTIONS MUST BE REFERRED TO THE IBM PURCHASING DEPARTMENT.				IBM CONFIDENTIAL	

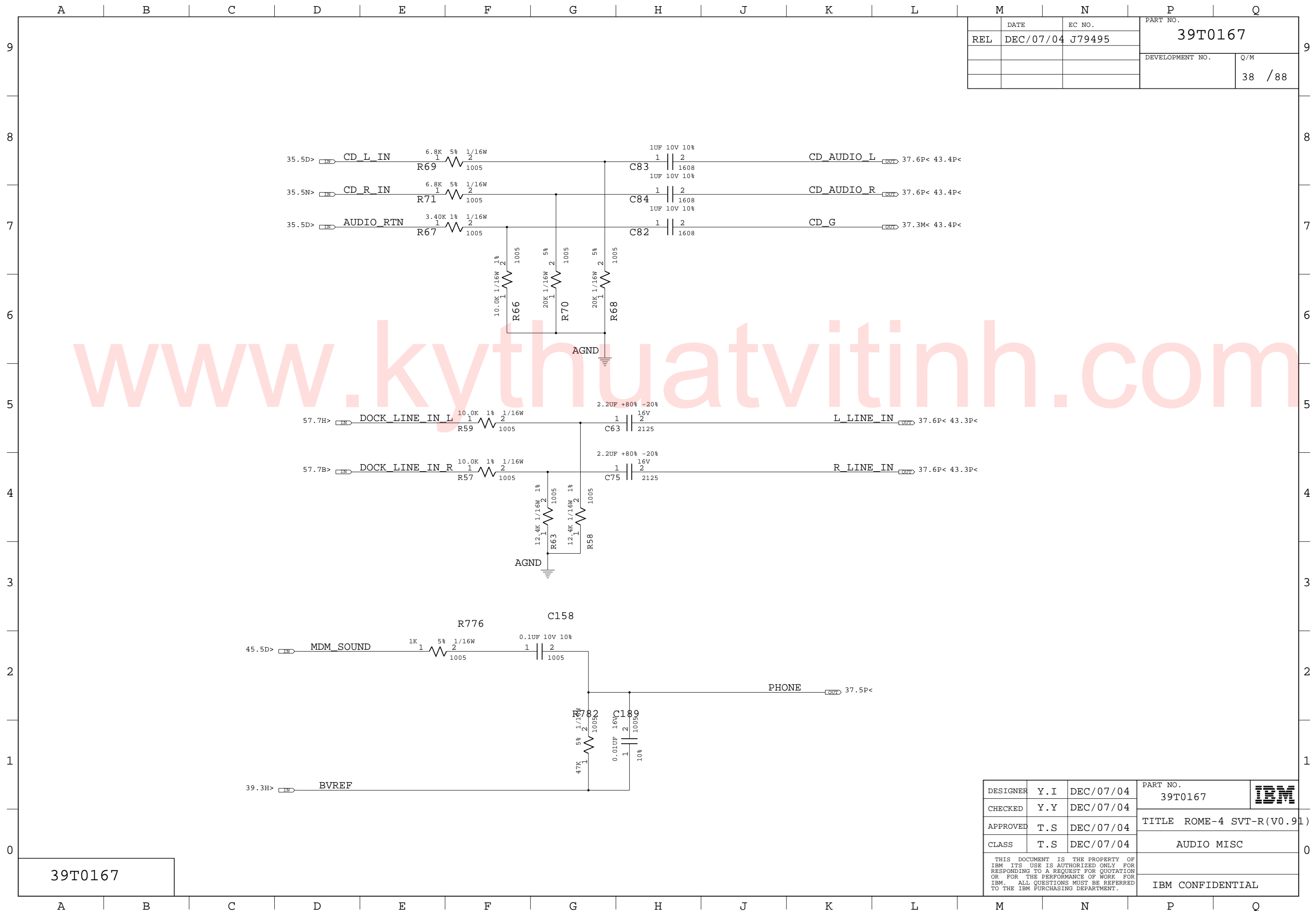

REL	DATE	EC NO.	PART NO.	
	DEC/07/04	J79495	39T0167	
			DEVELOPMENT NO.	Q/M
				38 / 88

39T0167

DESIGNER	Y. I	DEC/07/04	PART NO.	39T0167	
CHECKED	Y. Y	DEC/07/04			
APPROVED	T. S	DEC/07/04	TITLE ROME-4 SVT-R (V0.91)		
CLASS	T. S	DEC/07/04	AUDIO MISC		
THIS DOCUMENT IS THE PROPERTY OF IBM ITS USE IS AUTHORIZED ONLY FOR RESPONDING TO A REQUEST FOR QUOTATION OR FOR THE PERFORMANCE OF WORK FOR IBM. ALL QUESTIONS MUST BE REFERRED TO THE IBM PURCHASING DEPARTMENT.				IBM CONFIDENTIAL	

DATE	EC NO.	PART NO.
REL DEC/07/04	J79495	39T0167
		DEVELOPMENT NO.
		Q/M
		39 / 88

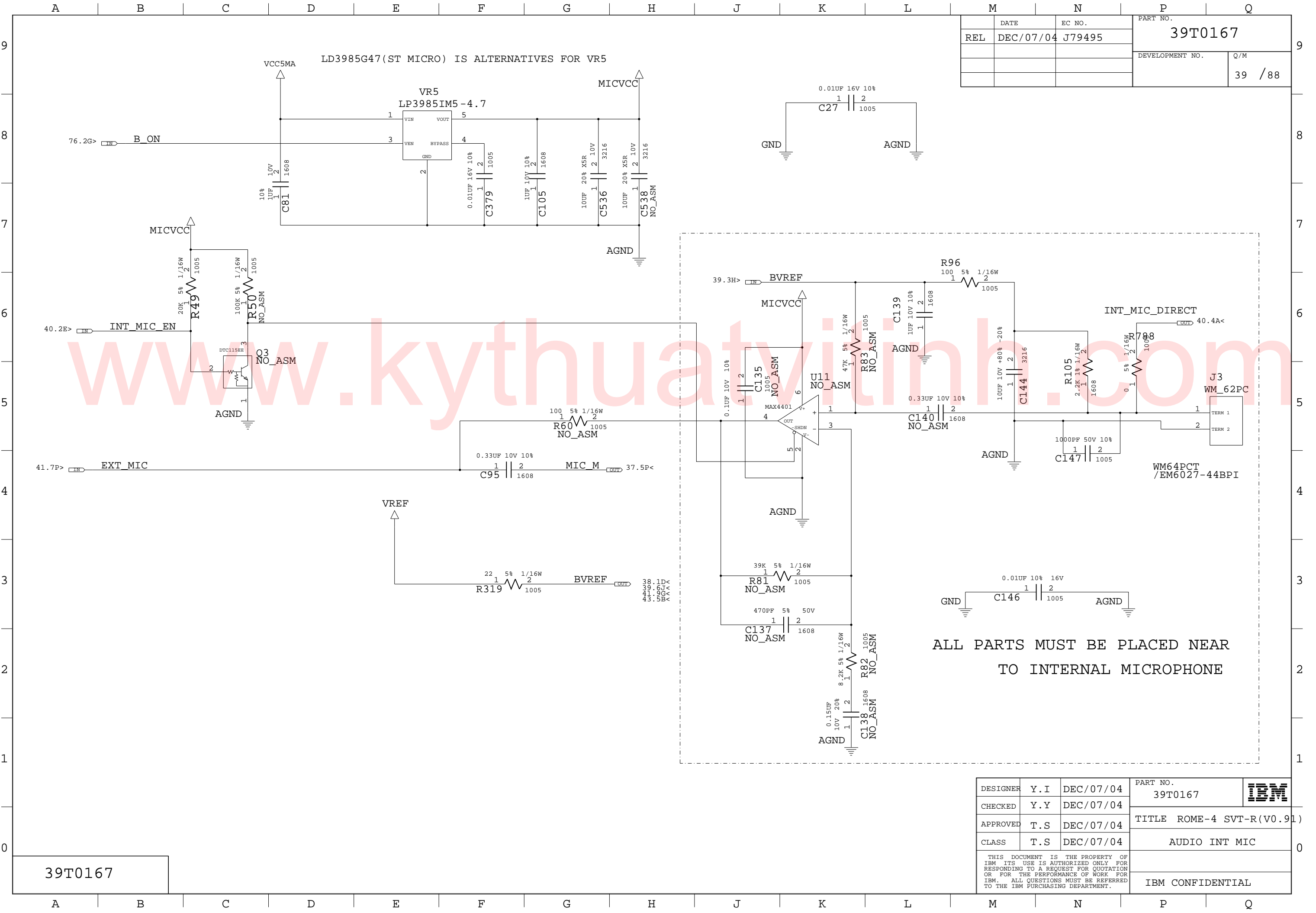

39T0167

DESIGNER	Y.I	DEC/07/04	PART NO.	39T0167	IBM
CHECKED	Y.Y	DEC/07/04			
APPROVED	T.S	DEC/07/04	TITLE ROME-4 SVT-R(V0.91)		
CLASS	T.S	DEC/07/04	AUDIO INT MIC		
THIS DOCUMENT IS THE PROPERTY OF IBM ITS USE IS AUTHORIZED ONLY FOR RESPONDING TO A REQUEST FOR QUOTATION OR FOR THE PERFORMANCE OF WORK FOR IBM. ALL QUESTIONS MUST BE REFERRED TO THE IBM PURCHASING DEPARTMENT.				IBM CONFIDENTIAL	

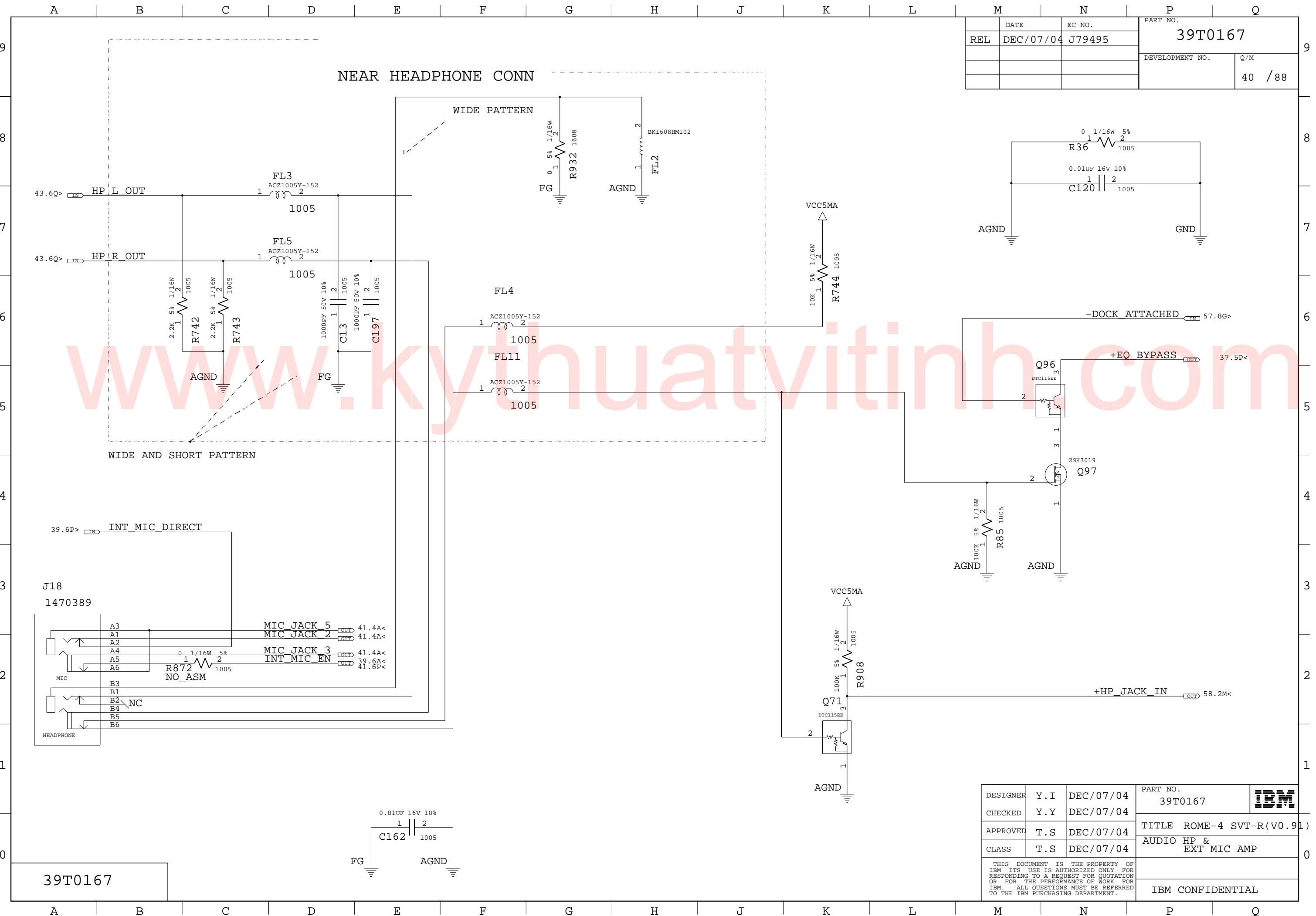

DATE	EC NO.	PART NO.
REL DEC/07/04	J79495	39T0167
		DEVELOPMENT NO.
		Q/M
		40 / 88

39T0167

DESIGNER	Y.I	DEC/07/04	PART NO.	39T0167	IBM
CHECKED	Y.Y	DEC/07/04			
APPROVED	T.S	DEC/07/04	TITLE	ROME-4 SVT-R (V0.91)	
CLASS	T.S	DEC/07/04		AUDIO HP & EXT MIC AMP	
THIS DOCUMENT IS THE PROPERTY OF IBM. ITS USE IS AUTHORIZED ONLY FOR RESPONDING TO A REQUEST FOR QUOTATION OR FOR THE PERFORMANCE OF WORK FOR IBM. ALL QUESTIONS MUST BE REFERRED TO THE IBM PURCHASING DEPARTMENT.				IBM CONFIDENTIAL	

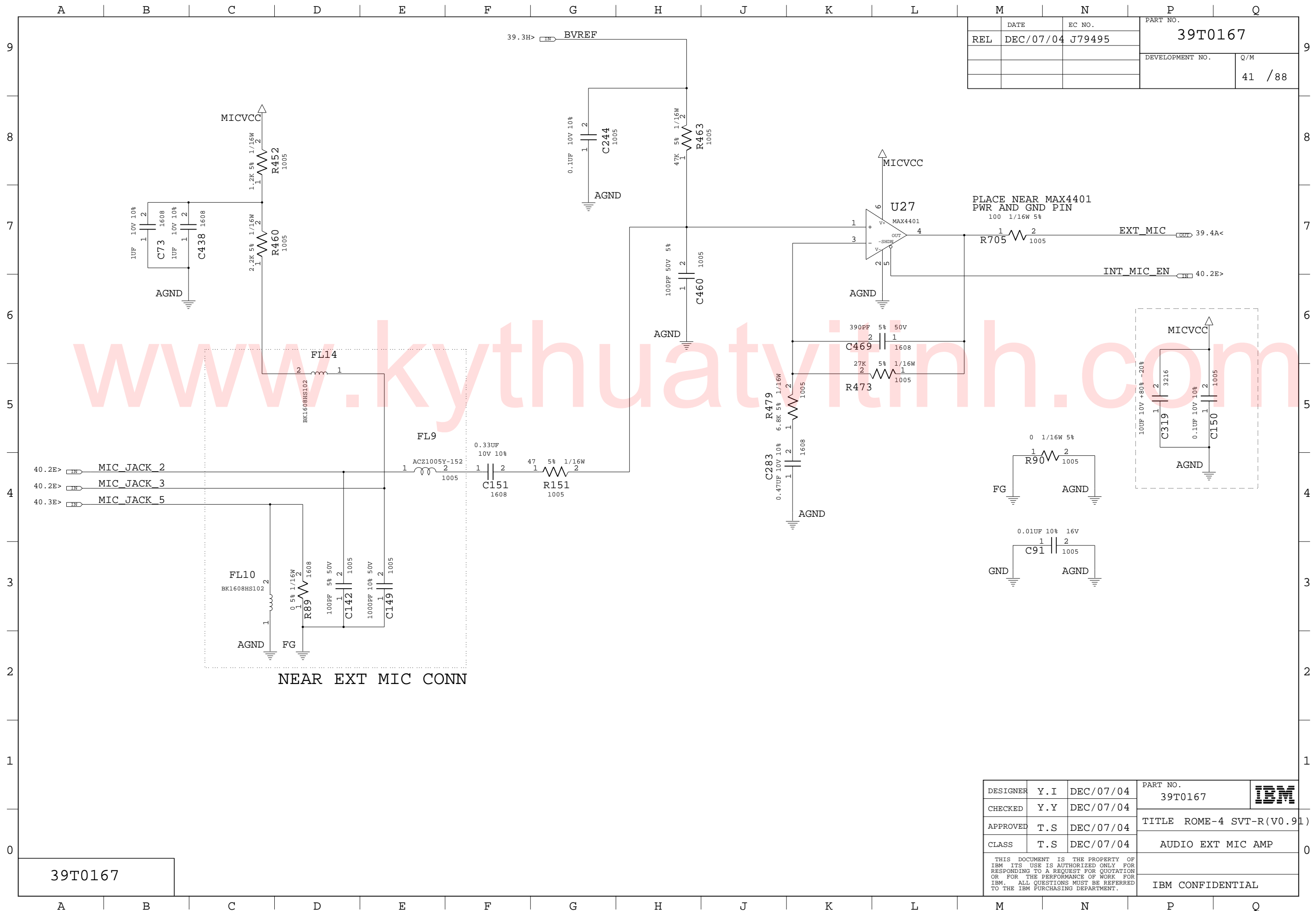

DATE	EC NO.	PART NO.
REL DEC/07/04	J79495	39T0167
		DEVELOPMENT NO.
		Q/M
		41 / 88

PLACE NEAR MAX4401
PWR AND GND PIN
100 1/16W 5%

NEAR EXT MIC CONN

39T0167

DESIGNER	Y.I	DEC/07/04	PART NO.	39T0167	IBM
CHECKED	Y.Y	DEC/07/04			
APPROVED	T.S	DEC/07/04	TITLE ROME-4 SVT-R(V0.91)		
CLASS	T.S	DEC/07/04	AUDIO EXT MIC AMP		
THIS DOCUMENT IS THE PROPERTY OF IBM ITS USE IS AUTHORIZED ONLY FOR RESPONDING TO A REQUEST FOR QUOTATION OR FOR THE PERFORMANCE OF WORK FOR IBM. ALL QUESTIONS MUST BE REFERRED TO THE IBM PURCHASING DEPARTMENT.				IBM CONFIDENTIAL	

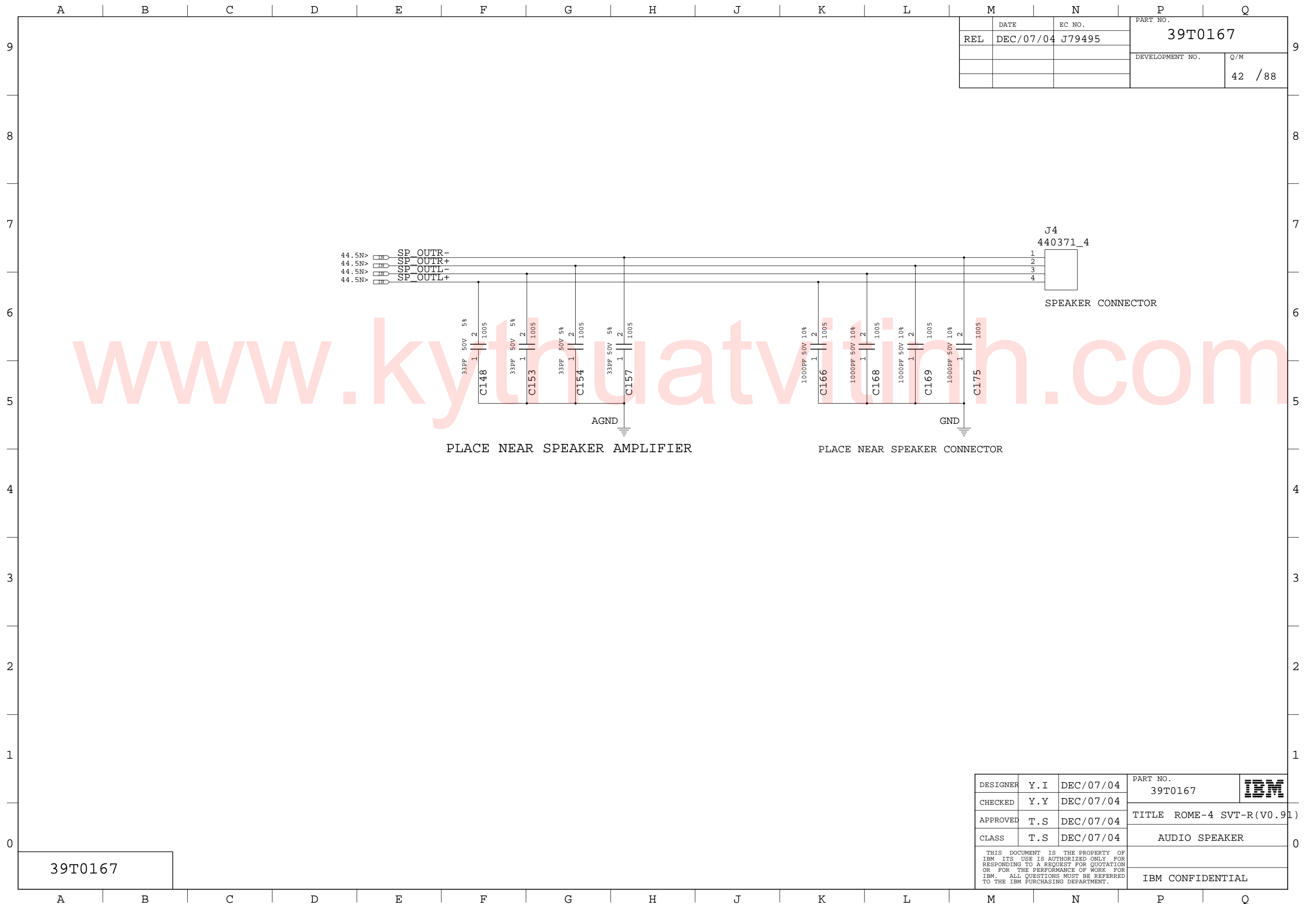

	DATE	EC NO.	PART NO.	
REL	DEC/07/04	J79495	39T0167	
			DEVELOPMENT NO.	Q/M
				42 / 88

39T0167

DESIGNER	Y. I	DEC/07/04	PART NO.	39T0167	IBM
CHECKED	Y. Y	DEC/07/04			
APPROVED	T. S	DEC/07/04	TITLE ROME-4 SVT-R(V0.91)		
CLASS	T. S	DEC/07/04	AUDIO SPEAKER		
THIS DOCUMENT IS THE PROPERTY OF IBM ITS USE IS AUTHORIZED ONLY FOR RESPONDING TO A REQUEST FOR QUOTATION OR FOR THE PERFORMANCE OF WORK FOR IBM. ALL QUESTIONS MUST BE REFERRED TO THE IBM PURCHASING DEPARTMENT.				IBM CONFIDENTIAL	

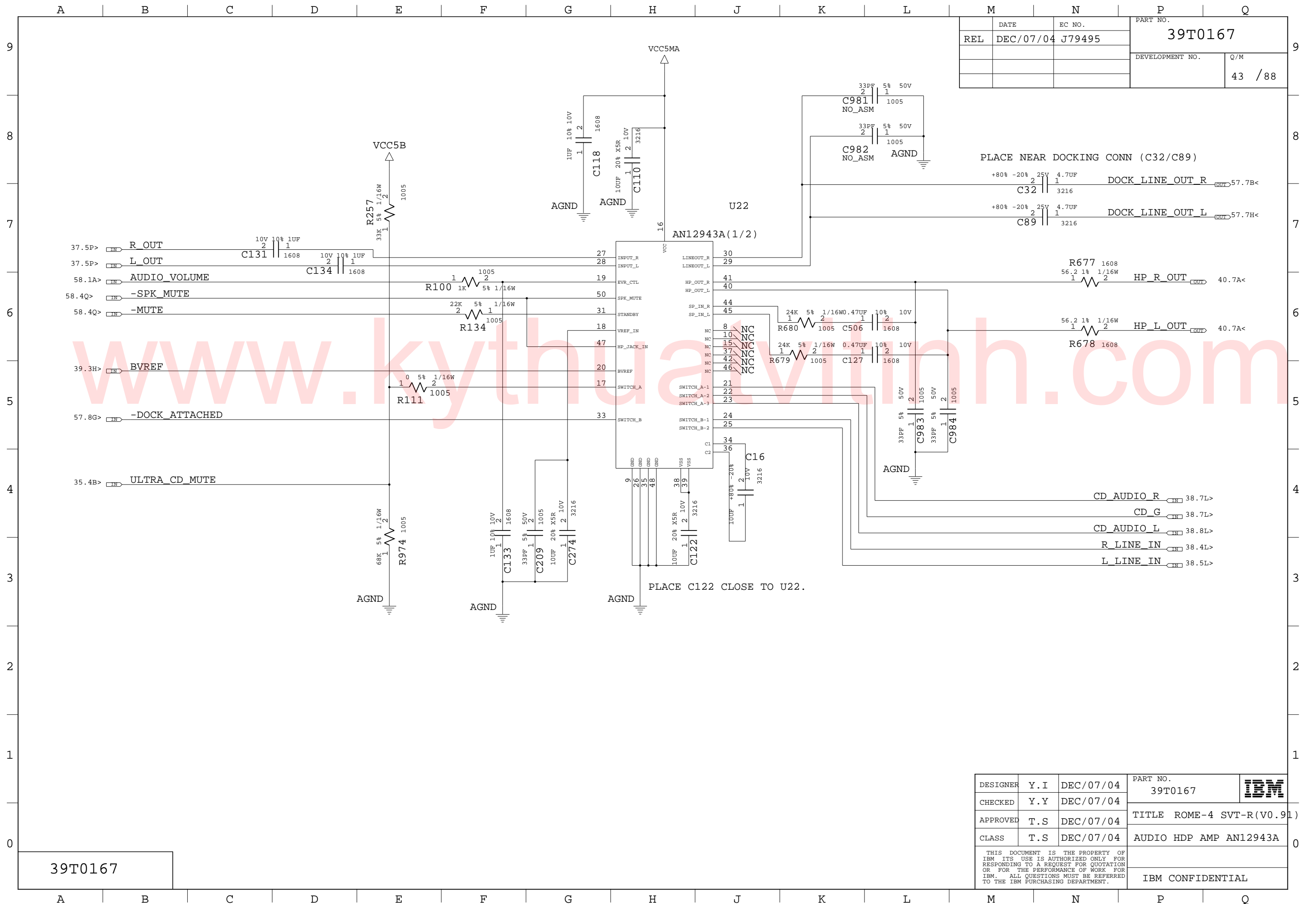

DATE	DEC/07/04	EC NO.	J79495	PART NO.	39T0167
REL				DEVELOPMENT NO.	Q/M
					43 / 88

PLACE NEAR DOCKING CONN (C32/C89)

+80% -20% 25V 4.7UF DOCK_LINE_OUT_R (OUT) 57.7B<

+80% -20% 25V 4.7UF DOCK_LINE_OUT_L (OUT) 57.7H<

R677 1608 56.2 1% 1/16W HP_R_OUT (OUT) 40.7A<

R678 1608 56.2 1% 1/16W HP_L_OUT (OUT) 40.7A<

CD_AUDIO_R (IN) 38.7L>

CD_G (IN) 38.7L>

CD_AUDIO_L (IN) 38.8L>

R_LINE_IN (IN) 38.4L>

L_LINE_IN (IN) 38.5L>

PLACE C122 CLOSE TO U22.

39T0167

DESIGNER	Y.I	DEC/07/04	PART NO.	39T0167	
CHECKED	Y.Y	DEC/07/04	TITLE	ROME-4 SVT-R(V0.91)	
APPROVED	T.S	DEC/07/04	CLASS	AUDIO HDP AMP AN12943A	
THIS DOCUMENT IS THE PROPERTY OF IBM ITS USE IS AUTHORIZED ONLY FOR RESPONDING TO A REQUEST FOR QUOTATION OR FOR THE PERFORMANCE OF WORK FOR IBM. ALL QUESTIONS MUST BE REFERRED TO THE IBM PURCHASING DEPARTMENT.				IBM CONFIDENTIAL	

	DATE	EC NO.	PART NO.	
REL	DEC/07/04	J79495	39T0167	
			DEVELOPMENT NO.	Q/M
				44 / 88

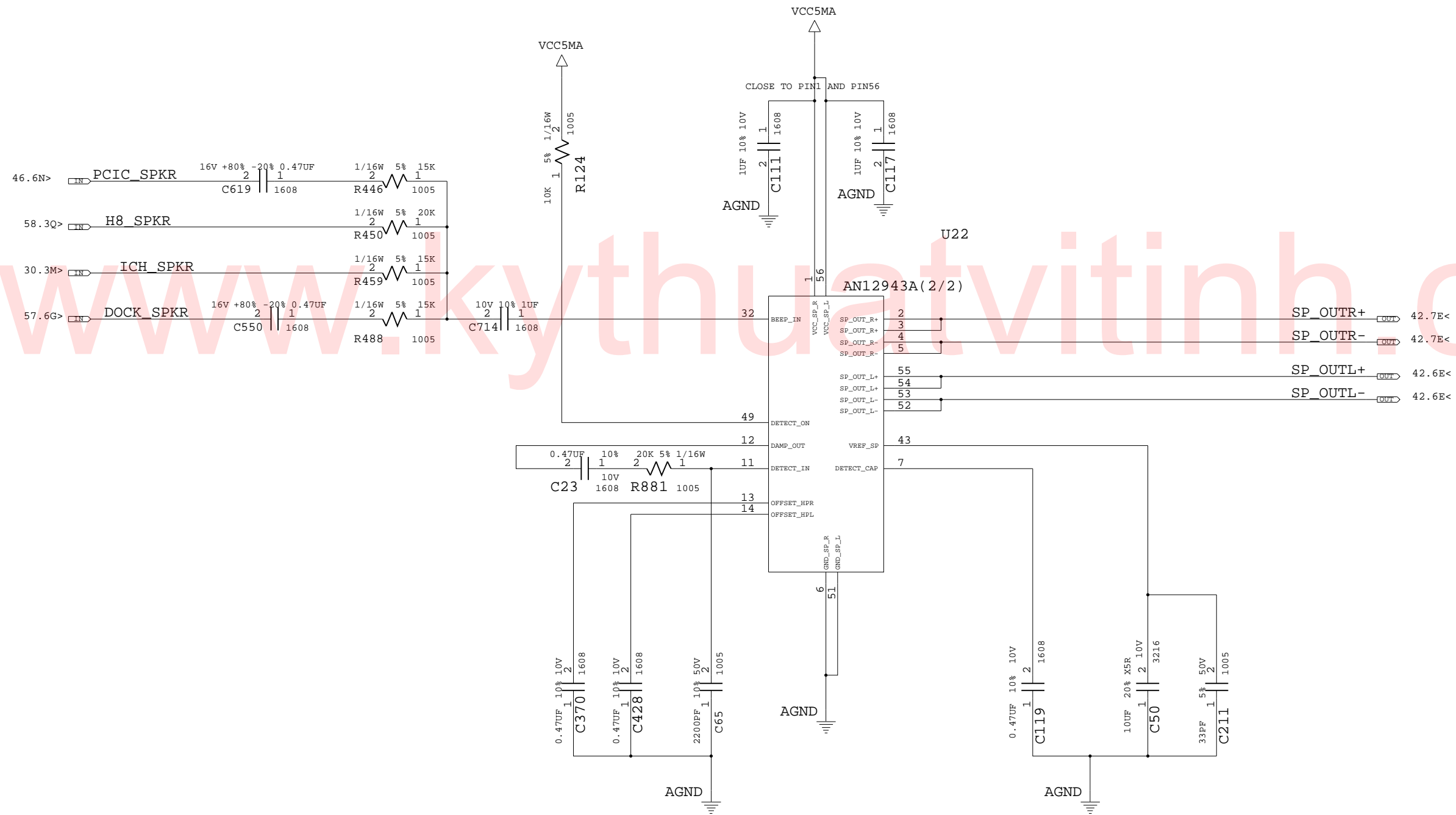

39T0167

DESIGNER	Y.I	DEC/07/04	PART NO.	39T0167	
CHECKED	Y.Y	DEC/07/04			
APPROVED	T.S	DEC/07/04	TITLE ROME-4 SVT-R(V0.91)		
CLASS	T.S	DEC/07/04	AUDIO HDP AMP AN12943A		
THIS DOCUMENT IS THE PROPERTY OF IBM ITS USE IS AUTHORIZED ONLY FOR RESPONDING TO A REQUEST FOR QUOTATION OR FOR THE PERFORMANCE OF WORK FOR IBM. ALL QUESTIONS MUST BE REFERRED TO THE IBM PURCHASING DEPARTMENT.				IBM CONFIDENTIAL	

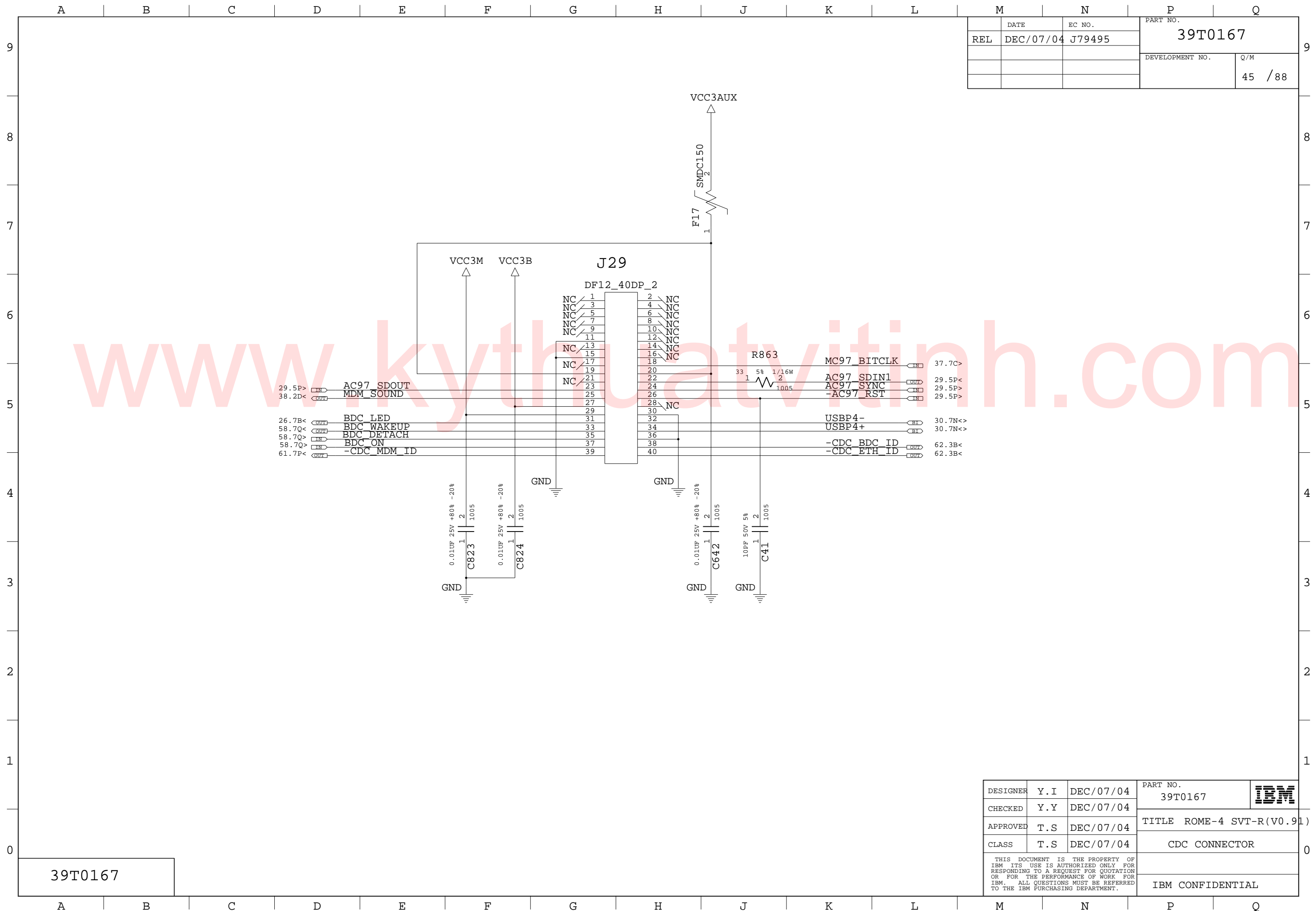

	DATE	EC NO.	PART NO.	
REL	DEC/07/04	J79495	39T0167	
			DEVELOPMENT NO.	Q/M
				45 / 88

39T0167

DESIGNER	Y. I	DEC/07/04	PART NO.	39T0167	
CHECKED	Y. Y	DEC/07/04			
APPROVED	T. S	DEC/07/04	TITLE ROME-4 SVT-R(V0.91)		
CLASS	T. S	DEC/07/04	CDC CONNECTOR		
THIS DOCUMENT IS THE PROPERTY OF IBM. ITS USE IS AUTHORIZED ONLY FOR RESPONDING TO A REQUEST FOR QUOTATION OR FOR THE PERFORMANCE OF WORK FOR IBM. ALL QUESTIONS MUST BE REFERRED TO THE IBM PURCHASING DEPARTMENT.				IBM CONFIDENTIAL	

DATE	DEC/07/04	EC NO.	J79495	PART NO.	39T0167
REL				DEVELOPMENT NO.	46 / 88
				Q/M	

56.9A<> 55.8B<> 29.8C<> AD<31..0>

TABLE 1394 1/1
N-1394 Y-1394

U20	R5C821	R5C851
FL6	NO-ASM	ASM
C943	NO-ASM	ASM
C945	NO-ASM	ASM
R399	NO-ASM	ASM
C942	NO-ASM	ASM
R944	NO-ASM	ASM
C256	NO-ASM	ASM
R946	NO-ASM	ASM
R947	NO-ASM	ASM
R949	NO-ASM	ASM
R950	NO-ASM	ASM
C949	NO-ASM	ASM
R948	NO-ASM	ASM
C946	NO-ASM	ASM
C951	NO-ASM	ASM
J20	NO-ASM	ASM
C944	NO-ASM	ASM
R945	NO-ASM	ASM
Y7	NO-ASM	ASM
C947	NO-ASM	ASM
C948	NO-ASM	ASM
R948	NO-ASM	ASM

PAGE 62

LOGIC

56.8A<> 55.8B<> 29.9C<> C BE<3..0>

- 61.5B< 56.7L<> 55.4N<> 29.5C<> -FRAME
- 61.5B< 56.7L<> 55.5C<> 29.5C<> -IRDY
- 56.7L<> 55.4N<> 29.5C<> -TRDY
- 56.6L<> 55.4N<> 29.5C<> -DEVSEL
- 56.7L<> 55.4N<> 29.5C<> -STOP
- 56.6L<> 55.5N<> 29.5C<> -PAR
- 56.5L<> 55.4C<> 29.5C<> -PERR
- 29.4C< 56.6L> 55.4C> -SERR
- 29.4C< -REQ
- 29.3C> -GNT
- 19.2B> PCICLK CB 33M
- 29.4C> -PCIRST
- 84.2K> 30.2M> MPWRG
- 61.7P> -CARDBUSPDN

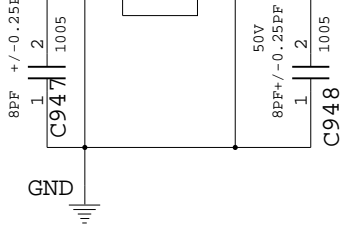
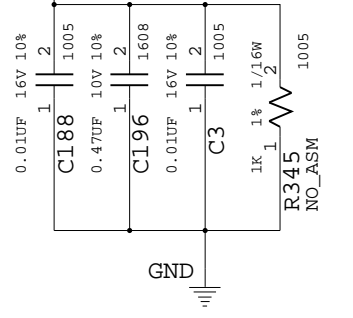
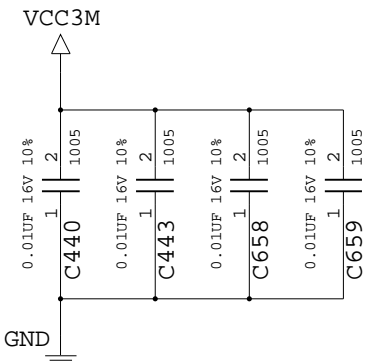
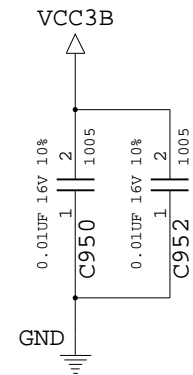
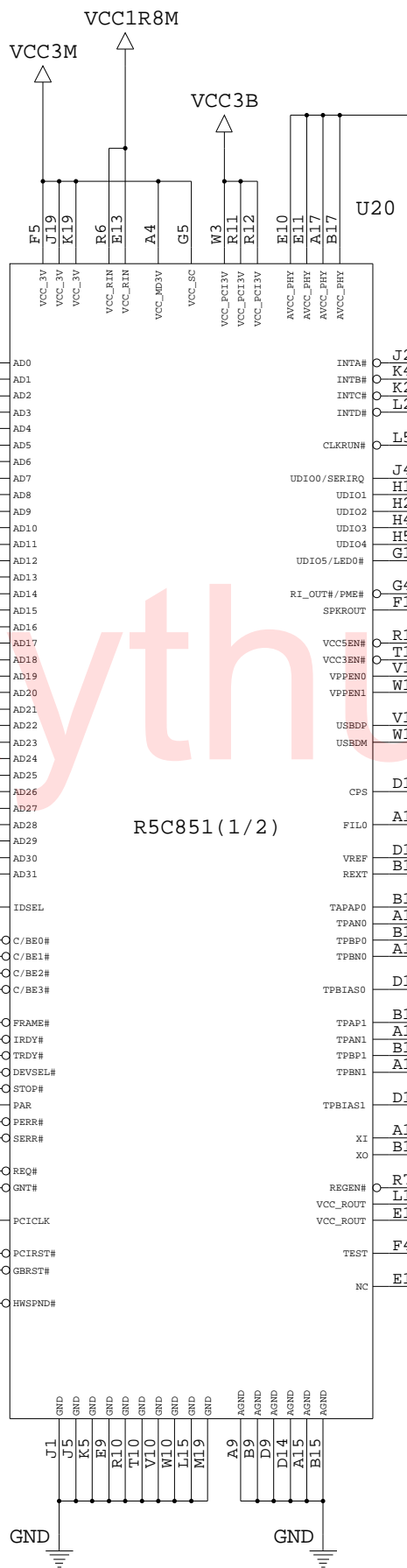

DESIGNER	Y.I	DEC/07/04	PART NO.	39T0167	
CHECKED	Y.Y	DEC/07/04			
APPROVED	T.S	DEC/07/04	TITLE ROME-4 SVT-R(V0.91)		
CLASS	T.S	DEC/07/04	CARD BUS CONTROLLER(1/2)		
THIS DOCUMENT IS THE PROPERTY OF IBM ITS USE IS AUTHORIZED ONLY FOR RESPONDING TO A REQUEST FOR QUOTATION OR FOR THE PERFORMANCE OF WORK FOR IBM. ALL QUESTIONS MUST BE REFERRED TO THE IBM PURCHASING DEPARTMENT.					IBM CONFIDENTIAL

39T0167

REL	DATE DEC/07/04	EC NO. J79495	PART NO. 39T0167
			DEVELOPMENT NO. Q/M 47 / 88

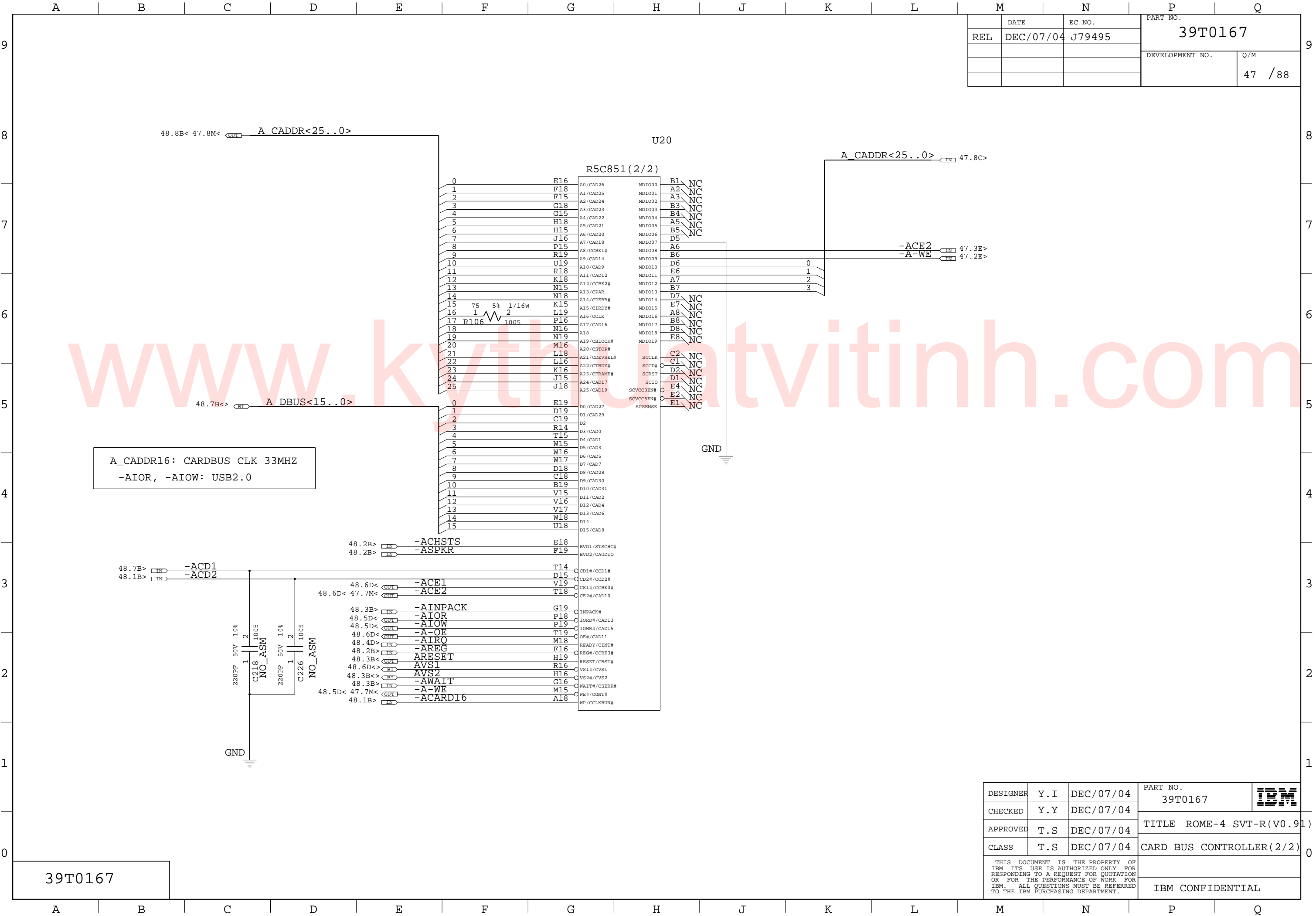

A_CADDR16: CARDBUS CLK 33MHZ
-AIOR, -AIOW: USB2.0

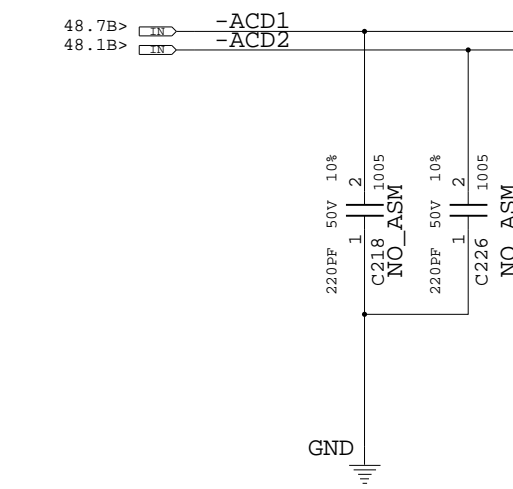

39T0167

DESIGNER	Y.I	DEC/07/04	PART NO. 39T0167	IBM
CHECKED	Y.Y	DEC/07/04		
APPROVED	T.S	DEC/07/04	TITLE ROME-4 SVT-R(V0.91)	
CLASS	T.S	DEC/07/04	CARD BUS CONTROLLER(2/2)	
THIS DOCUMENT IS THE PROPERTY OF IBM ITS USE IS AUTHORIZED ONLY FOR RESPONDING TO A REQUEST FOR QUOTATION OR FOR THE PERFORMANCE OF WORK FOR IBM. ALL QUESTIONS MUST BE REFERRED TO THE IBM PURCHASING DEPARTMENT.				IBM CONFIDENTIAL

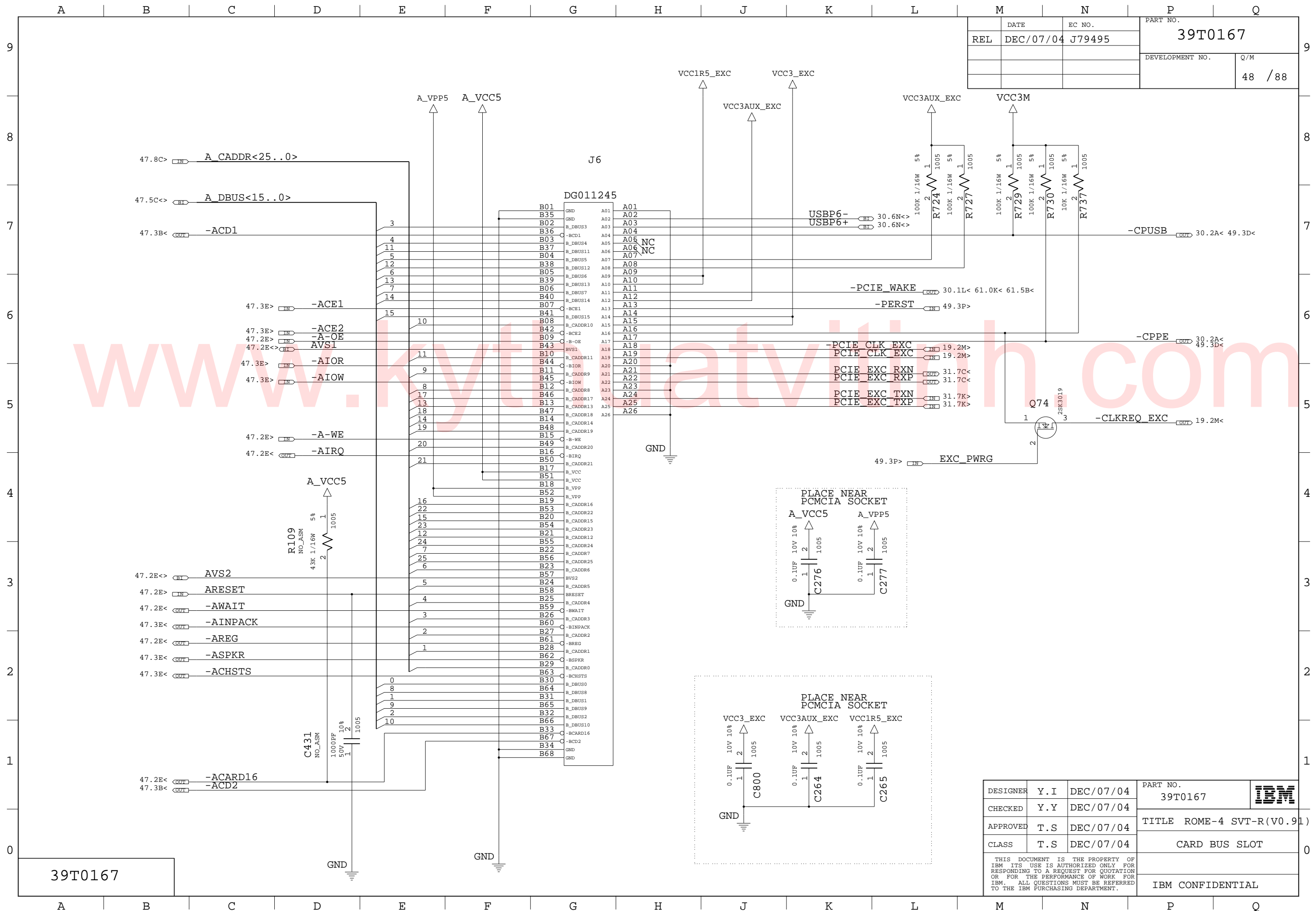

DATE	EC NO.	PART NO.
REL DEC/07/04	J79495	39T0167
DEVELOPMENT NO.		Q/M
		48 / 88

39T0167

DESIGNER	Y.I	DEC/07/04	PART NO.	39T0167	
CHECKED	Y.Y	DEC/07/04			
APPROVED	T.S	DEC/07/04	TITLE ROME-4 SVT-R(V0.91)		
CLASS	T.S	DEC/07/04	CARD BUS SLOT		
THIS DOCUMENT IS THE PROPERTY OF IBM. ITS USE IS AUTHORIZED ONLY FOR RESPONDING TO A REQUEST FOR QUOTATION OR FOR THE PERFORMANCE OF WORK FOR IBM. ALL QUESTIONS MUST BE REFERRED TO THE IBM PURCHASING DEPARTMENT.				IBM CONFIDENTIAL	

	DATE	EC NO.	PART NO.
REL	DEC/07/04	J79495	39T0167
			DEVELOPMENT NO.
			Q/M
			49 / 88

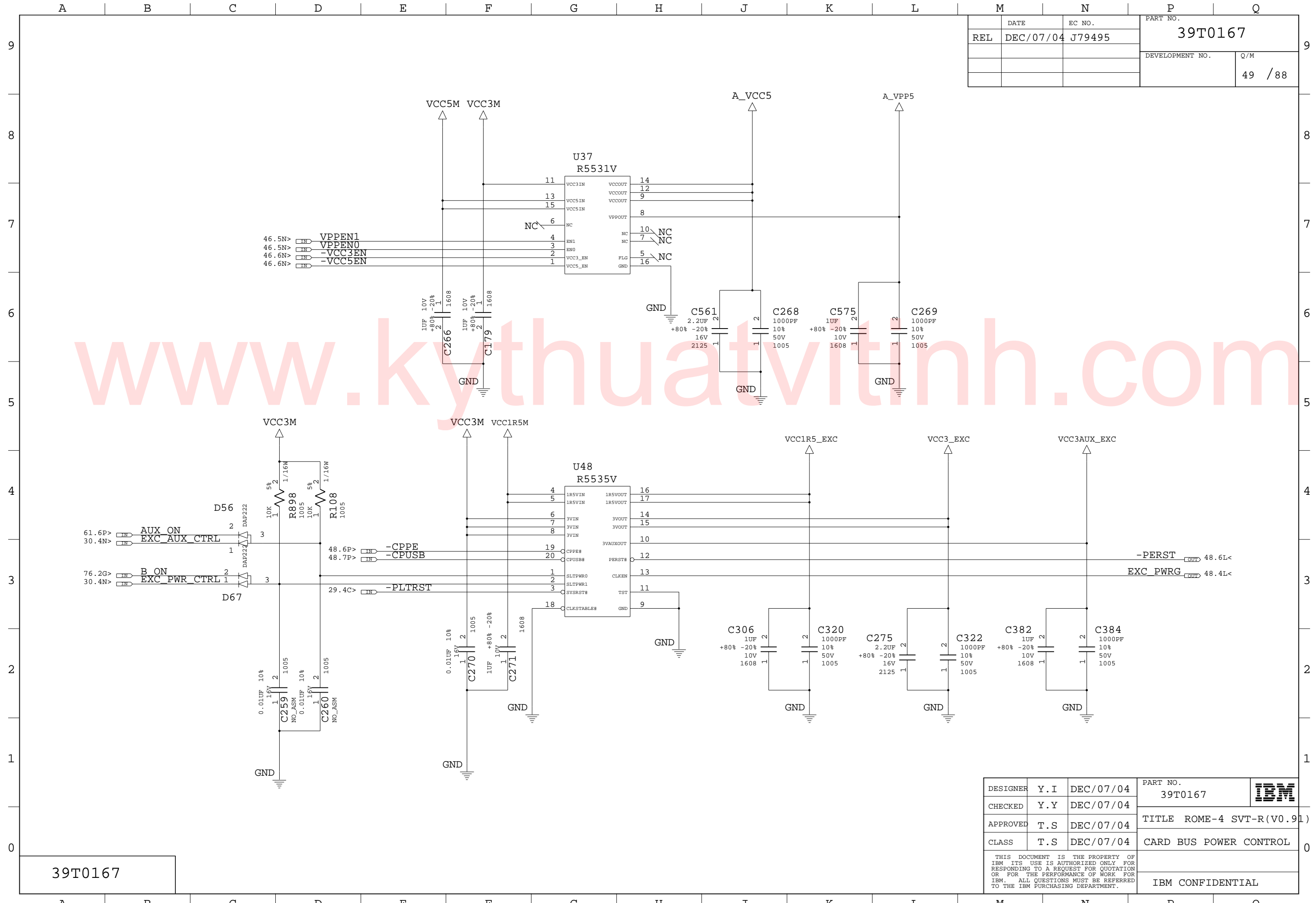

39T0167

DESIGNER	Y.I	DEC/07/04	PART NO.	39T0167	IBM
CHECKED	Y.Y	DEC/07/04			
APPROVED	T.S	DEC/07/04	TITLE ROME-4 SVT-R(V0.91)		
CLASS	T.S	DEC/07/04	CARD BUS POWER CONTROL		
THIS DOCUMENT IS THE PROPERTY OF IBM ITS USE IS AUTHORIZED ONLY FOR RESPONDING TO A REQUEST FOR QUOTATION OR FOR THE PERFORMANCE OF WORK FOR IBM. ALL QUESTIONS MUST BE REFERRED TO THE IBM PURCHASING DEPARTMENT.				IBM CONFIDENTIAL	

REL	DATE	EC NO.	PART NO.
	DEC/07/04	J79495	39T0167
			DEVELOPMENT NO.
			Q/M
			51 / 88

BCM5751M	B0/B1
R16	NO_ASM
R45	NO_ASM
R345	NO_ASM
R347	NO_ASM
R681	NO_ASM
R682	NO_ASM
R683	NO_ASM
R684	NO_ASM

ASM
ASM

LOGIC

C999	C998	U10
10V 10% 0.1UF	10V 10% 0.1UF	BCM5751M(1/3)
31.8C<	PCIE_GBE_RXP	N06
31.8C<	PCIE_GBE_RXN	P06
31.8L>	PCIE_GBE_TXP	P10
31.8L>	PCIE_GBE_TXN	N10
	-PCIE_WAKE_GBE	A06
29.4C>	-PLTRST	C02
19.3M>	PCIE_CLK_GBE	N08
19.3M>	-PCIE_CLK_GBE	P08

U10

BCM5751M(1/3)

TRD3-	E14	MDI1-3	BI	53.7B<>
TRD3+	E13	MDI1-3	BI	53.7B<>
TRD2-	D14	MDI1-3	BI	53.7B<>
TRD2+	D13	MDI1-3	BI	53.7B<>
TRD1-	C14	MDI1-3	BI	53.6B<>
TRD1+	C13	MDI1-3	BI	53.5B<>
TRD0-	B14	MDI1-3	BI	53.5B<>
TRD0+	B13	MDI1-3	BI	53.5B<>
PCIE_TST	D08			
LINKLED#	A11	-RJ45 LINKUP	OUT	54.3E< 57.3J<
SPD100LED#	B11			
SPD100LED#	A12	-RJ45 ACTIVITY	OUT	54.3E< 57.4J<
TRAFFICLED#	B10			
WL_LINK2_4G	C10	NC	NC	
WL_LINK5G	B09	NC	NC	
WL_ACTIVITY	A09	NC	NC	
PWR_INDS#	H02	NC	NC	
ATTN_INDS#	J02	NC	NC	
ATTN_BTN#	A02	NC	NC	
SMB_CLK	D10			
SMB_DATA	D09			
XTALO	N12			
XTALI	P12			
RDAC	A10			
GPIO0_TST_CLKOUT	G12			
GPIO1	H13			
GPIO2	G13			
ERDATA	L10			
ERCLK	K11			
REGSUP25	L14			
REGOUT25	M14			
REGSUP12	K14	NC	NC	
REGCTL12	J13	NC	NC	
REGSEN12	J14	NC	NC	
LOW_PWR	L06			
VALXPRST	J12			
WOL_INRSH	P14	NC	NC	
VALX_ON#	M13	NC	NC	
VMAIN_ON#	N14	NC	NC	
TRST#	D12			
TCK	D07	NC	NC	
TDI	H12	NC	NC	
TDO	D06	NC	NC	
TMS	C13	NC	NC	

VCC3AUX

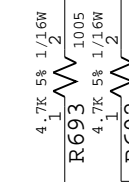

BROADCOM FAE RECOMMENDED

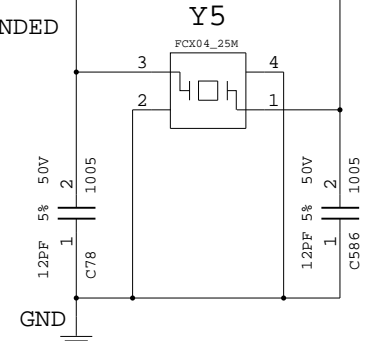

CRYSTAL LOAD CAP VALUES WILL VARY WITH PAD SIZE AND STACKUP ADJUST CRYSTAL DISCRETE LOADING CAPS TO PROVIDE 25.000MHZ(+/- 50PPM) AT THE SILICON XTAL 2PIN

BCM5751M	A1/B0
R713	ASM

LOGIC

39T0167

DESIGNER	Y.I	DEC/07/04	PART NO.	39T0167	IBM
CHECKED	Y.Y	DEC/07/04	TITLE	ROME-4 SVT-R(V0.91)	
APPROVED	T.S	DEC/07/04		GBE BCM5751M(1/2)	
CLASS	T.S	DEC/07/04			
THIS DOCUMENT IS THE PROPERTY OF IBM. ITS USE IS AUTHORIZED ONLY FOR RESPONDING TO A REQUEST FOR QUOTATION OR FOR THE PERFORMANCE OF WORK FOR IBM. ALL QUESTIONS MUST BE REFERRED TO THE IBM PURCHASING DEPARTMENT.					IBM CONFIDENTIAL

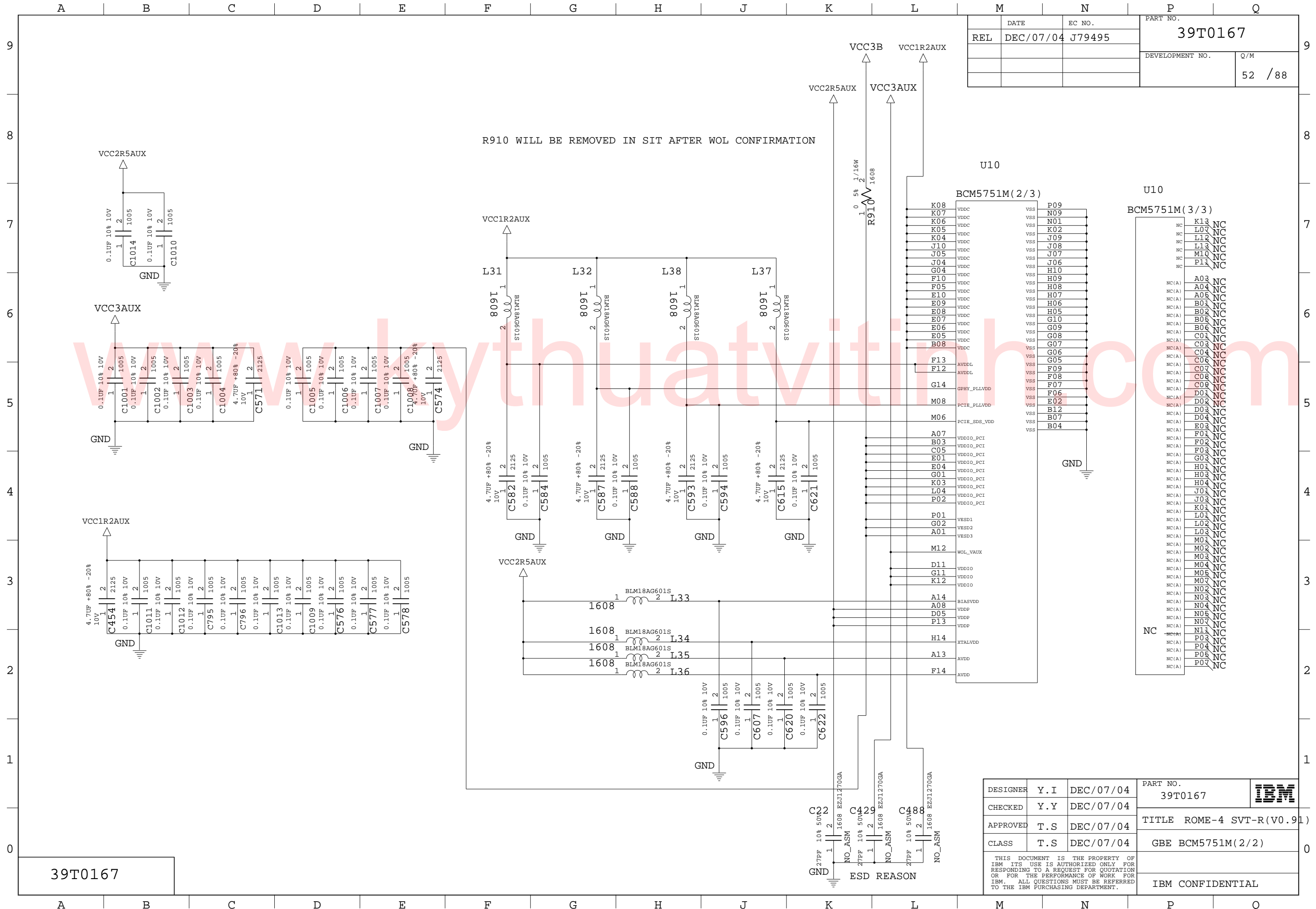

DATE	DEC/07/04	EC NO.	J79495	PART NO.	39T0167
REL				DEVELOPMENT NO.	Q/M
					52 / 88

R910 WILL BE REMOVED IN SIT AFTER WOL CONFIRMATION

DESIGNER	Y.I	DEC/07/04	PART NO.	39T0167	
CHECKED	Y.Y	DEC/07/04	TITLE ROME-4 SVT-R (V0.91)		
APPROVED	T.S	DEC/07/04	GBE BCM5751M(2/2)		
CLASS	T.S	DEC/07/04	THIS DOCUMENT IS THE PROPERTY OF IBM. ITS USE IS AUTHORIZED ONLY FOR RESPONDING TO A REQUEST FOR QUOTATION OR FOR THE PERFORMANCE OF WORK FOR IBM. ALL QUESTIONS MUST BE REFERRED TO THE IBM PURCHASING DEPARTMENT.		IBM CONFIDENTIAL

39T0167

	DATE	EC NO.	PART NO.
REL	DEC/07/04	J79495	39T0167
			DEVELOPMENT NO.
			Q/M
			53 / 88

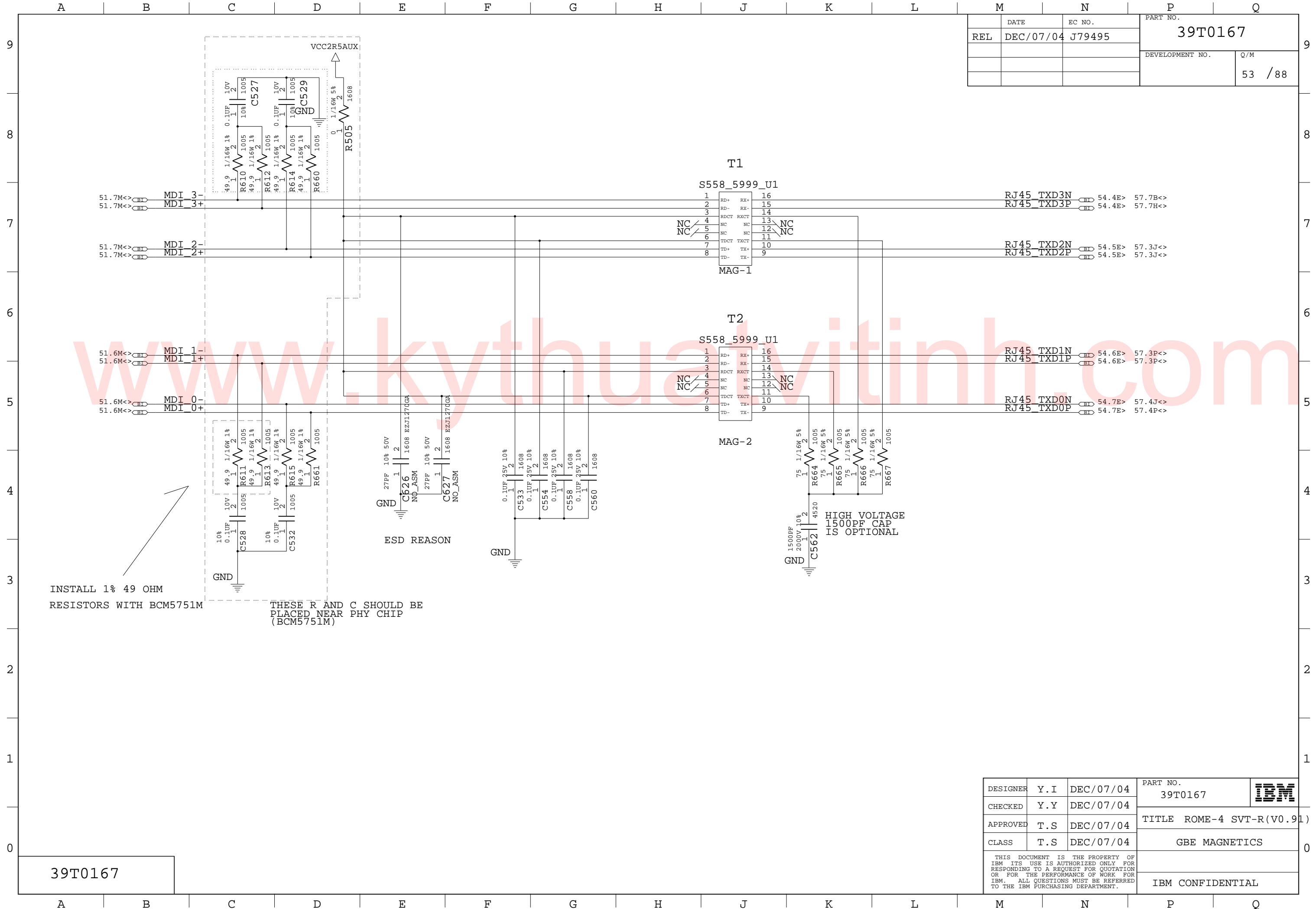

INSTALL 1% 49 OHM
RESISTORS WITH BCM5751M

THESE R AND C SHOULD BE
PLACED NEAR PHY CHIP
(BCM5751M)

ESD REASON

HIGH VOLTAGE
1500PF CAP
IS OPTIONAL

39T0167

DESIGNER	Y.I	DEC/07/04	PART NO.	IBM
CHECKED	Y.Y	DEC/07/04	39T0167	
APPROVED	T.S	DEC/07/04	TITLE ROME-4 SVT-R(V0.91)	
CLASS	T.S	DEC/07/04	GBE MAGNETICS	
THIS DOCUMENT IS THE PROPERTY OF IBM ITS USE IS AUTHORIZED ONLY FOR RESPONDING TO A REQUEST FOR QUOTATION OR FOR THE PERFORMANCE OF WORK FOR IBM. ALL QUESTIONS MUST BE REFERRED TO THE IBM PURCHASING DEPARTMENT.				IBM CONFIDENTIAL

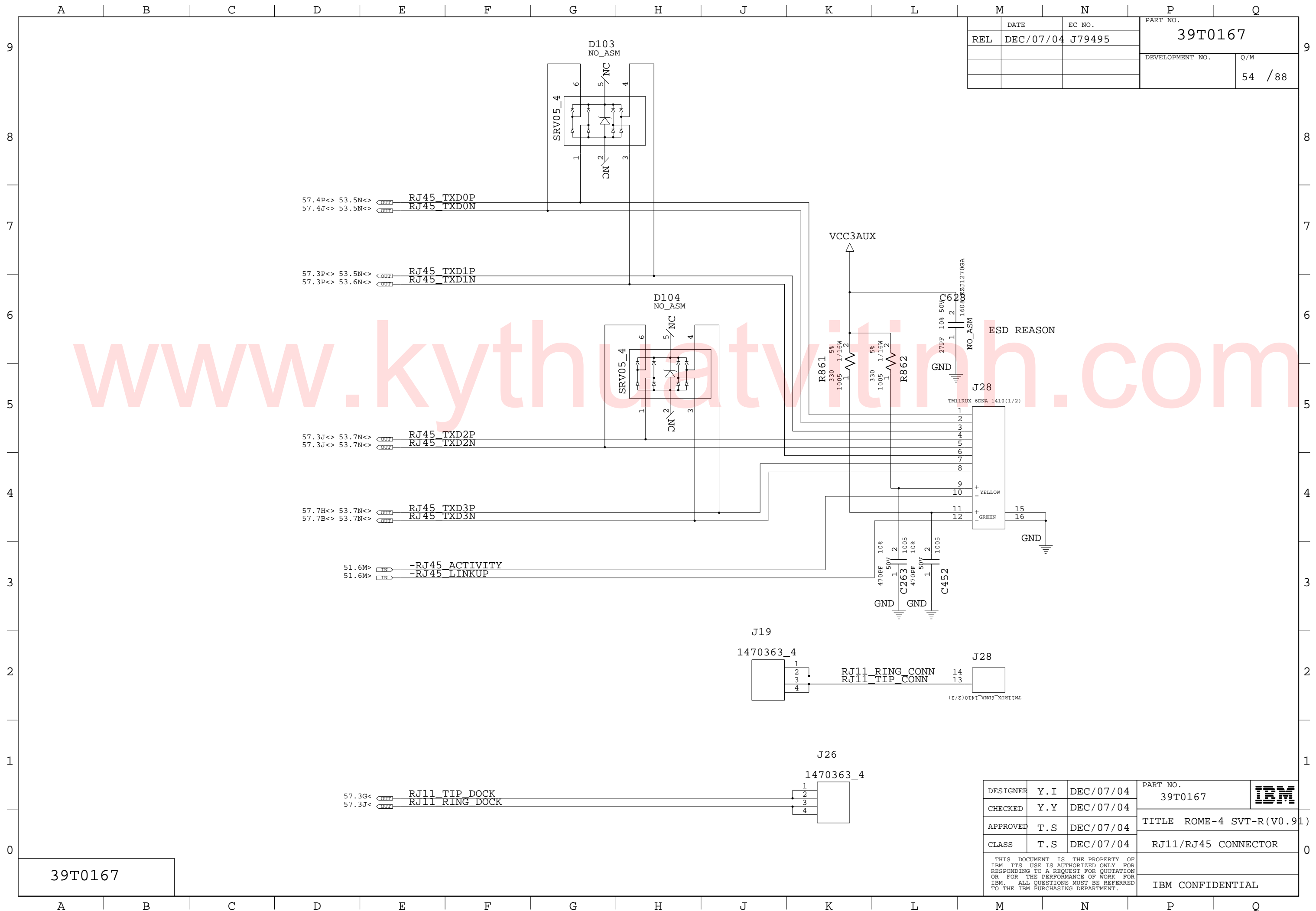

DATE	DEC/07/04	EC NO.	J79495	PART NO.	39T0167
REL				DEVELOPMENT NO.	54 / 88
				Q/M	

39T0167

DESIGNER	Y.I	DEC/07/04	PART NO.	39T0167	IBM
CHECKED	Y.Y	DEC/07/04	TITLE	ROME-4 SVT-R(V0.91)	
APPROVED	T.S	DEC/07/04	CLASS	RJ11/RJ45 CONNECTOR	
THIS DOCUMENT IS THE PROPERTY OF IBM. ITS USE IS AUTHORIZED ONLY FOR RESPONDING TO A REQUEST FOR QUOTATION OR FOR THE PERFORMANCE OF WORK FOR IBM. ALL QUESTIONS MUST BE REFERRED TO THE IBM PURCHASING DEPARTMENT.				IBM CONFIDENTIAL	

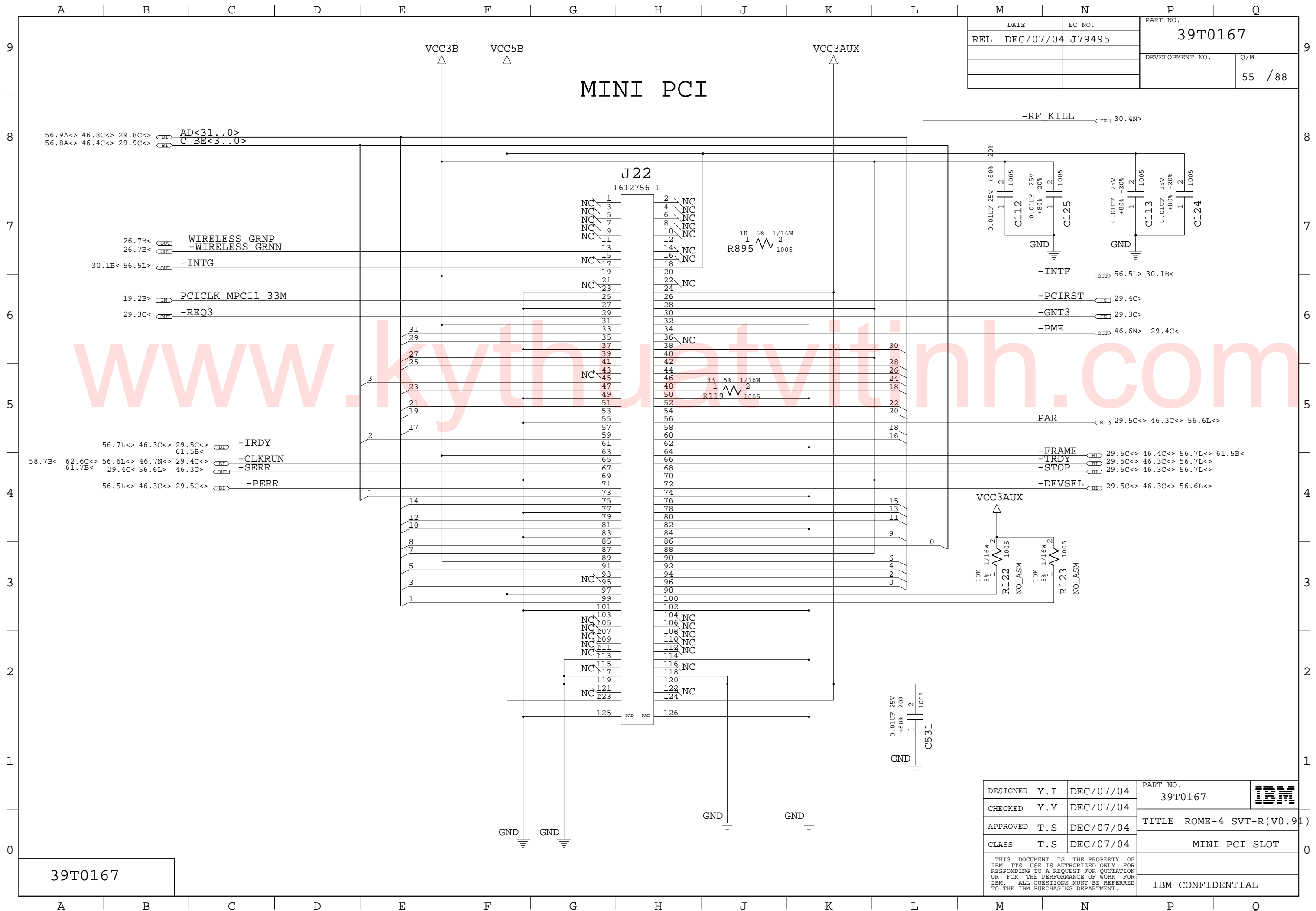

DATE	EC NO.	PART NO.
REL DEC/07/04	J79495	39T0167
DEVELOPMENT NO.		Q/M
		55 / 88

MINI PCI

J22

1612756_1

- 1 NC
- 2 NC
- 3 NC
- 4 NC
- 5 NC
- 6 NC
- 7 NC
- 8 NC
- 9 NC
- 10 NC
- 11 NC
- 12 NC
- 13 NC
- 14 NC
- 15 NC
- 16 NC
- 17 NC
- 18 NC
- 19 NC
- 20 NC
- 21 NC
- 22 NC
- 23 NC
- 24 NC
- 25 NC
- 26 NC
- 27 NC
- 28 NC
- 29 NC
- 30 NC
- 31 NC
- 32 NC
- 33 NC
- 34 NC
- 35 NC
- 36 NC
- 37 NC
- 38 NC
- 39 NC
- 40 NC
- 41 NC
- 42 NC
- 43 NC
- 44 NC
- 45 NC
- 46 NC
- 47 NC
- 48 NC
- 49 NC
- 50 NC
- 51 NC
- 52 NC
- 53 NC
- 54 NC
- 55 NC
- 56 NC
- 57 NC
- 58 NC
- 59 NC
- 60 NC
- 61 NC
- 62 NC
- 63 NC
- 64 NC
- 65 NC
- 66 NC
- 67 NC
- 68 NC
- 69 NC
- 70 NC
- 71 NC
- 72 NC
- 73 NC
- 74 NC
- 75 NC
- 76 NC
- 77 NC
- 78 NC
- 79 NC
- 80 NC
- 81 NC
- 82 NC
- 83 NC
- 84 NC
- 85 NC
- 86 NC
- 87 NC
- 88 NC
- 89 NC
- 90 NC
- 91 NC
- 92 NC
- 93 NC
- 94 NC
- 95 NC
- 96 NC
- 97 NC
- 98 NC
- 99 NC
- 100 NC
- 101 NC
- 102 NC
- 103 NC
- 104 NC
- 105 NC
- 106 NC
- 107 NC
- 108 NC
- 109 NC
- 110 NC
- 111 NC
- 112 NC
- 113 NC
- 114 NC
- 115 NC
- 116 NC
- 117 NC
- 118 NC
- 119 NC
- 120 NC
- 121 NC
- 122 NC
- 123 NC
- 124 NC
- 125 PAD
- 126 PAD

56.9A<> 46.8C<> 29.8C<>
56.8A<> 46.4C<> 29.9C<>

AD<31..0>
C BE<3..0>

26.7B< WIRELESS_GRP
26.7B< -WIRELESS_GRP

30.1B< 56.5L> -INTG

19.2B> PCICLK MPCII1_33M

29.3C< -REQ3

56.7L<> 46.3C<> 29.5C<> 61.5B<
58.7B< 62.6C<> 56.6L<> 46.7N<> 29.4C<>
61.7B< 29.4C< 56.6L> 46.3C>

-IRDY

-CLKRUN

-SERR

56.5L<> 46.3C<> 29.5C<> -PERR

-RF_KILL 30.4N>

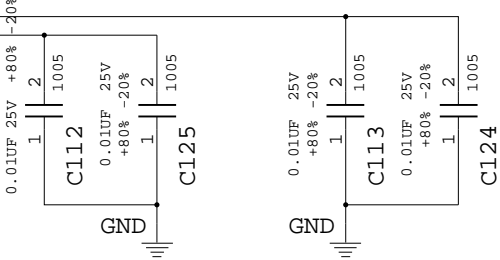

-INTF 56.5L> 30.1B<

-PCIRST 29.4C>

-GNT3 29.3C>

-PME 46.6N> 29.4C<

PAR 29.5C<> 46.3C<> 56.6L<>

-FRAME 29.5C<> 46.4C<> 56.7L<> 61.5B<

-TRDY 29.5C<> 46.3C<> 56.7L<>

-STOP 29.5C<> 46.3C<> 56.7L<>

-DEVSEL 29.5C<> 46.3C<> 56.6L<>

VCC3AUX

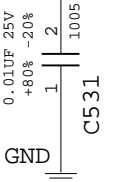
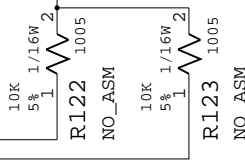

39T0167

DESIGNER	Y.I	DEC/07/04	PART NO.	39T0167	IBM
CHECKED	Y.Y	DEC/07/04			
APPROVED	T.S	DEC/07/04	TITLE ROME-4 SVT-R(V0.91)		
CLASS	T.S	DEC/07/04	MINI PCI SLOT		
THIS DOCUMENT IS THE PROPERTY OF IBM. ITS USE IS AUTHORIZED ONLY FOR RESPONDING TO A REQUEST FOR QUOTATION OR FOR THE PERFORMANCE OF WORK FOR IBM. ALL QUESTIONS MUST BE REFERRED TO THE IBM PURCHASING DEPARTMENT.				IBM CONFIDENTIAL	

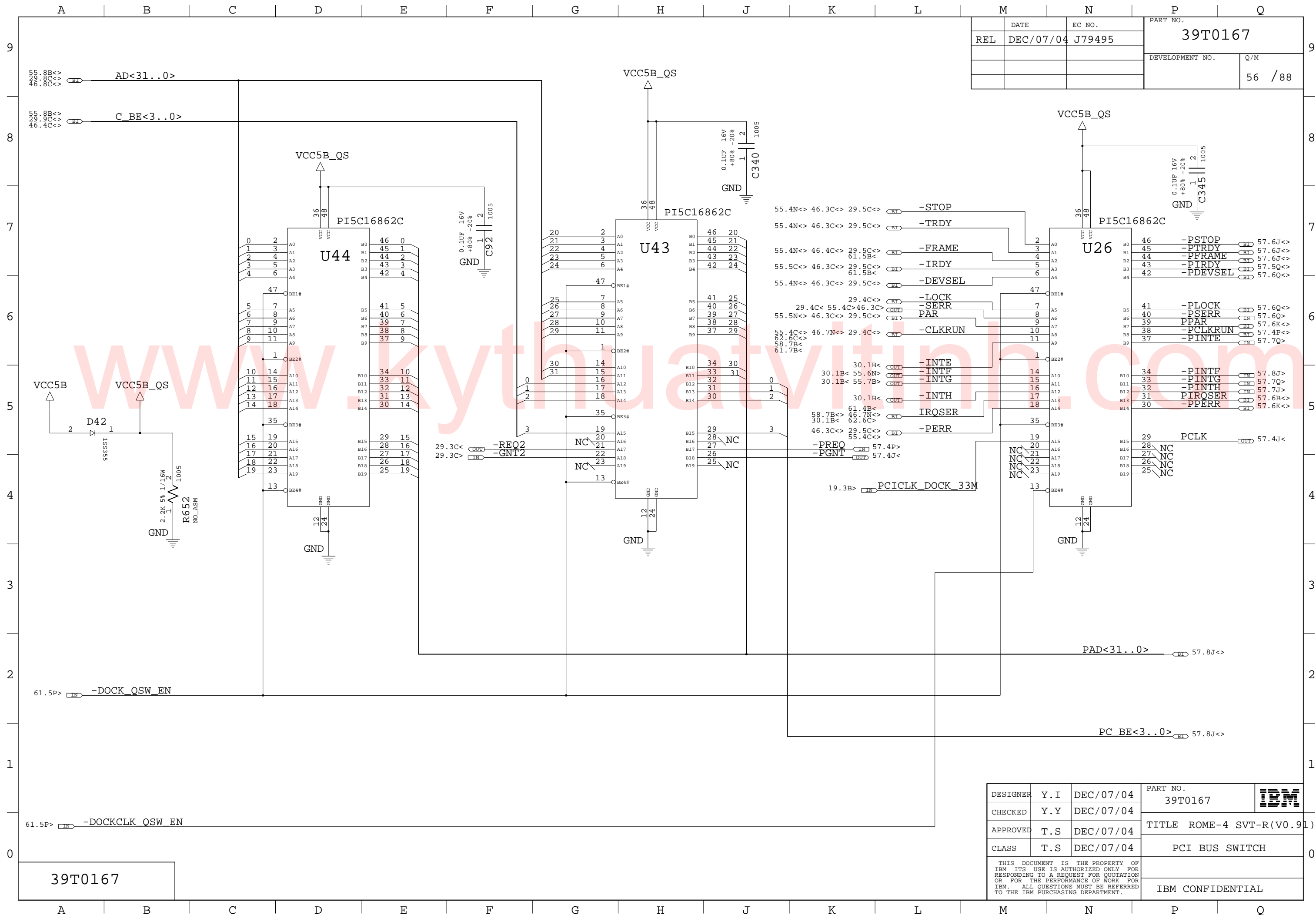

DATE	EC NO.	PART NO.
REL DEC/07/04	J79495	39T0167
DEVELOPMENT NO.		Q/M
		56 / 88

DESIGNER	Y.I	DEC/07/04	PART NO.	39T0167	IBM
CHECKED	Y.Y	DEC/07/04			
APPROVED	T.S	DEC/07/04	TITLE ROME-4 SVT-R (V0.91)		
CLASS	T.S	DEC/07/04	PCI BUS SWITCH		
THIS DOCUMENT IS THE PROPERTY OF IBM ITS USE IS AUTHORIZED ONLY FOR RESPONDING TO A REQUEST FOR QUOTATION OR FOR THE PERFORMANCE OF WORK FOR IBM. ALL QUESTIONS MUST BE REFERRED TO THE IBM PURCHASING DEPARTMENT.					IBM CONFIDENTIAL

39T0167

REL	DATE	EC NO.	PART NO.
	DEC/07/04	J79495	39T0167
			DEVELOPMENT NO.
			Q/M
			57 / 88

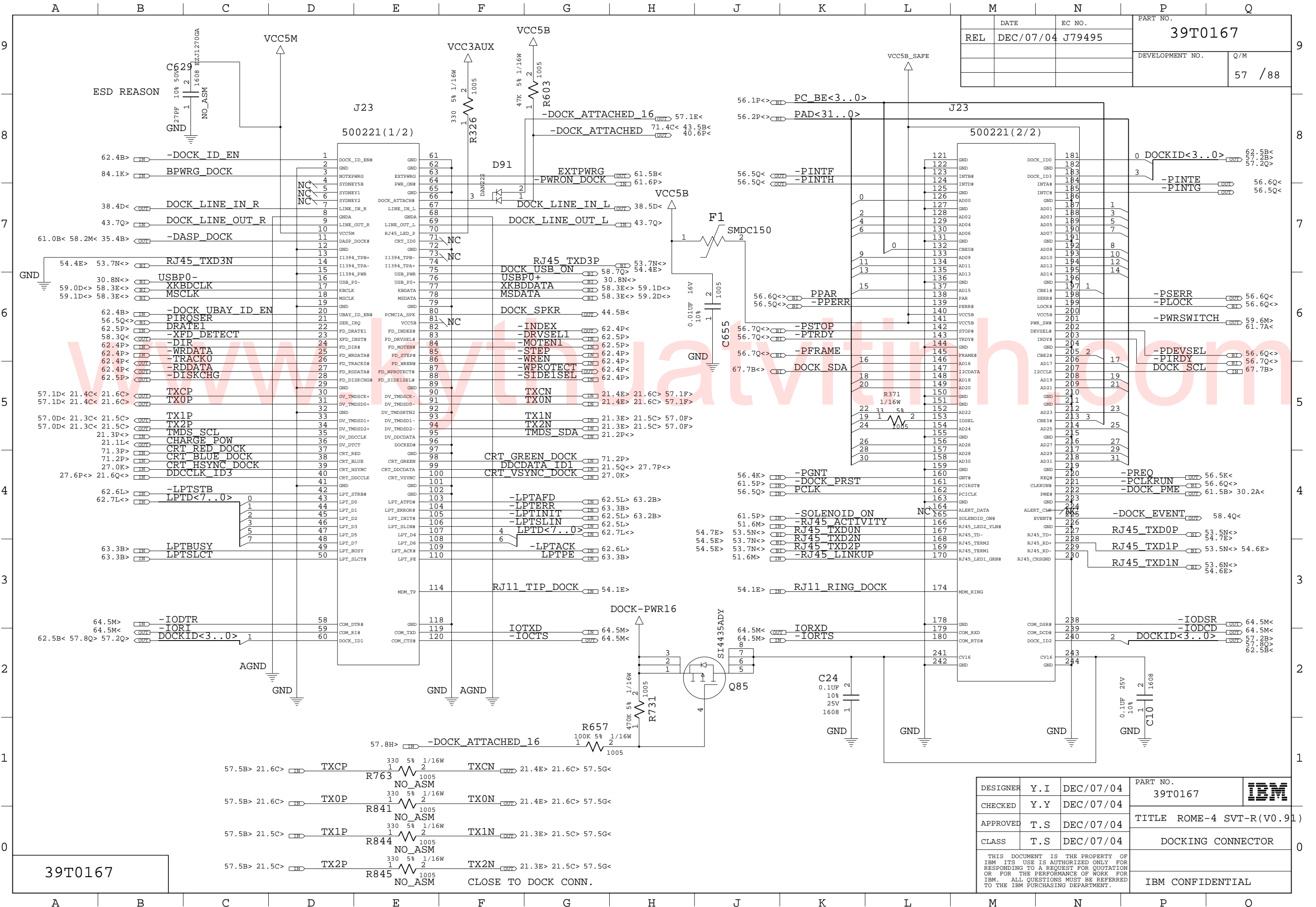

39T0167

DESIGNER	Y.I	DEC/07/04	PART NO.	39T0167	IBM
CHECKED	Y.Y	DEC/07/04			
APPROVED	T.S	DEC/07/04	TITLE ROME-4 SVT-R(V0.91)		
CLASS	T.S	DEC/07/04	DOCKING CONNECTOR		
THIS DOCUMENT IS THE PROPERTY OF IBM ITS USE IS AUTHORIZED ONLY FOR RESPONDING TO A REQUEST FOR QUOTATION OR FOR THE PERFORMANCE OF WORK FOR IBM. ALL QUESTIONS MUST BE REFERRED TO THE IBM PURCHASING DEPARTMENT.					IBM CONFIDENTIAL

REL	DATE	EC NO.	PART NO.
	DEC/07/04	J79495	39T0167
			DEVELOPMENT NO.
			Q/M
			58 / 88

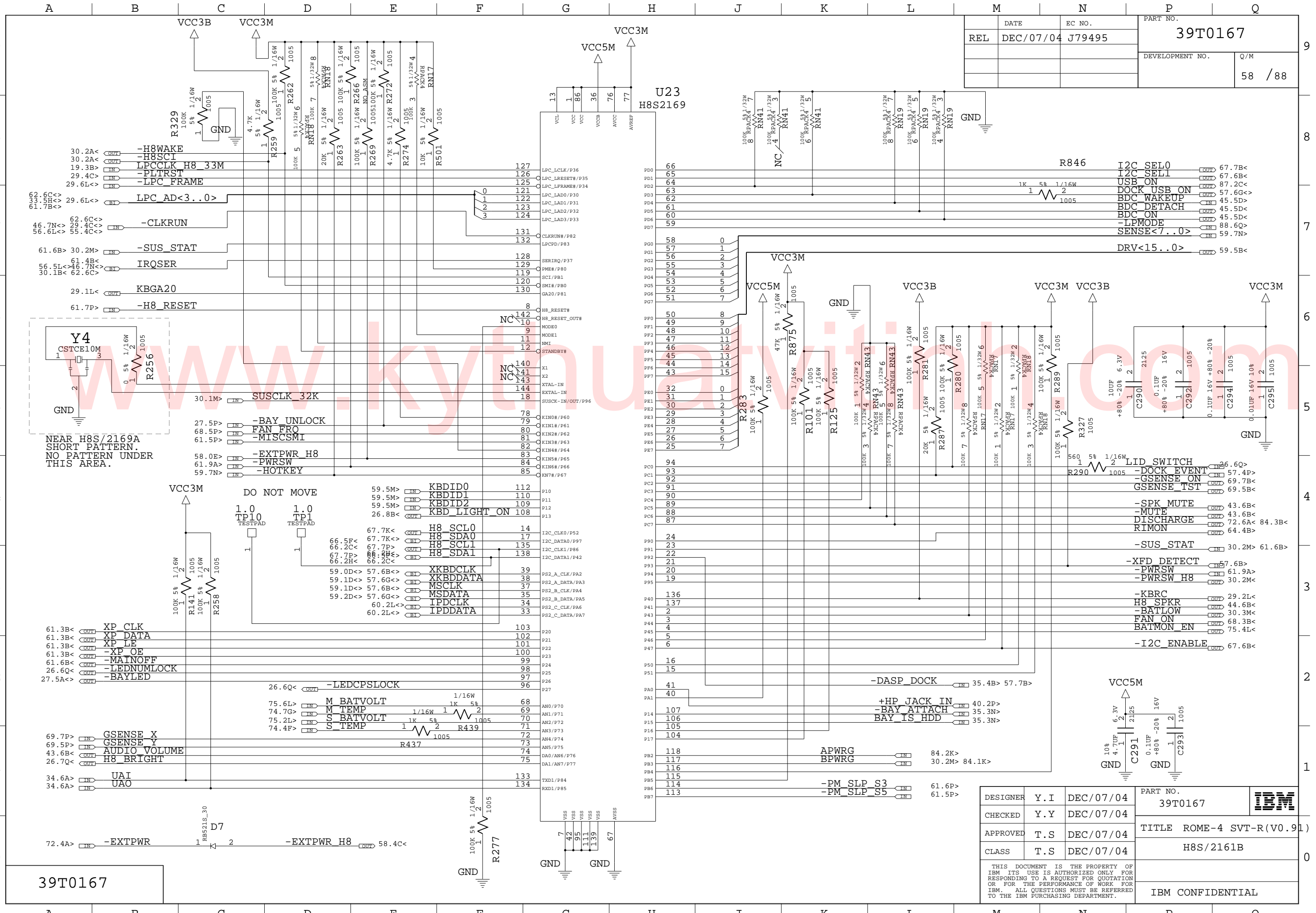

DESIGNER	Y.I	DEC/07/04	PART NO.	IBM
CHECKED	Y.Y	DEC/07/04	39T0167	
APPROVED	T.S	DEC/07/04	TITLE	ROME-4 SVT-R(V0.91)
CLASS	T.S	DEC/07/04		H8S/2161B
THIS DOCUMENT IS THE PROPERTY OF IBM ITS USE IS AUTHORIZED ONLY FOR RESPONDING TO A REQUEST FOR QUOTATION OR FOR THE PERFORMANCE OF WORK FOR IBM. ALL QUESTIONS MUST BE REFERRED TO THE IBM PURCHASING DEPARTMENT.				IBM CONFIDENTIAL

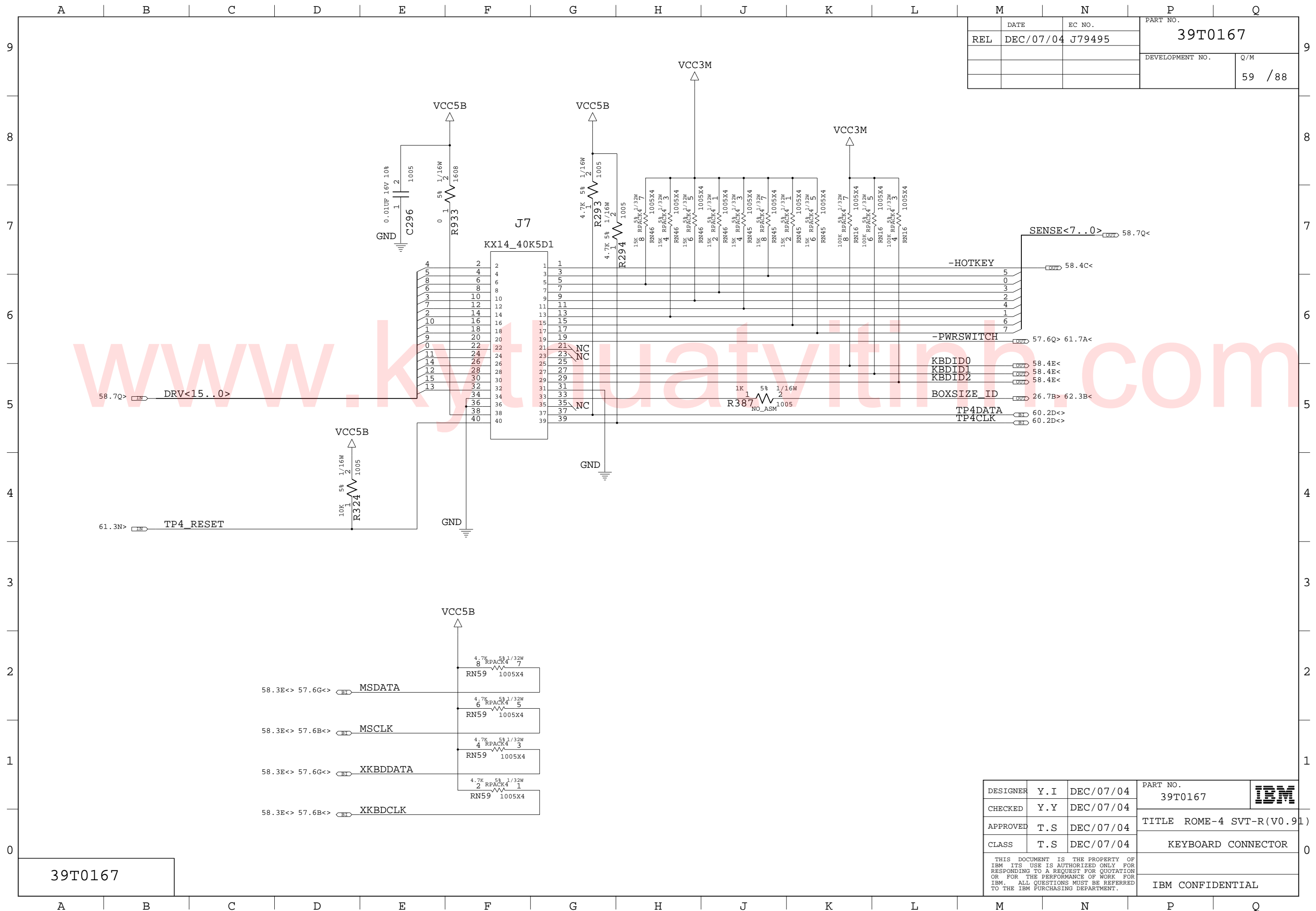

DATE	DEC/07/04	EC NO.	J79495	PART NO.	39T0167
REL				DEVELOPMENT NO.	Q/M
					59 / 88

39T0167

DESIGNER	Y.I	DEC/07/04	PART NO.	39T0167	IBM
CHECKED	Y.Y	DEC/07/04	TITLE ROME-4 SVT-R(V0.91)		
APPROVED	T.S	DEC/07/04	KEYBOARD CONNECTOR		
CLASS	T.S	DEC/07/04	IBM CONFIDENTIAL		

THIS DOCUMENT IS THE PROPERTY OF IBM. ITS USE IS AUTHORIZED ONLY FOR RESPONDING TO A REQUEST FOR QUOTATION OR FOR THE PERFORMANCE OF WORK FOR IBM. ALL QUESTIONS MUST BE REFERRED TO THE IBM PURCHASING DEPARTMENT.

	DATE	EC NO.	PART NO.
REL	DEC/07/04	J79495	39T0167
			DEVELOPMENT NO.
			Q/M
			60 / 88

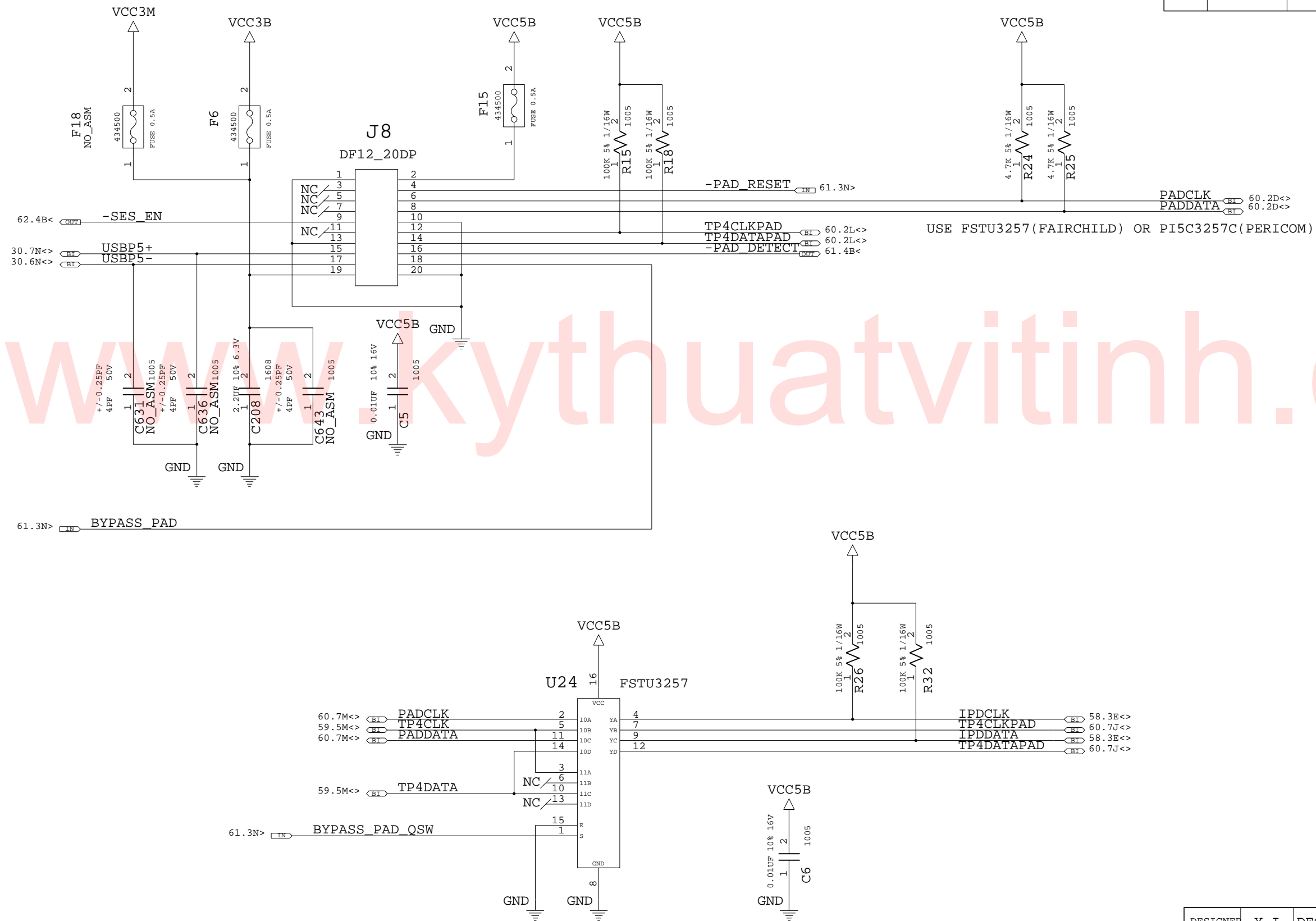

39T0167

DESIGNER	Y.I	DEC/07/04	PART NO.	IBM
CHECKED	Y.Y	DEC/07/04	39T0167	
APPROVED	T.S	DEC/07/04	TITLE ROME-4 SVT-R(V0.91)	
CLASS	T.S	DEC/07/04	TOUCH PAD CONNECTOR	
THIS DOCUMENT IS THE PROPERTY OF IBM ITS USE IS AUTHORIZED ONLY FOR RESPONDING TO A REQUEST FOR QUOTATION OR FOR THE PERFORMANCE OF WORK FOR IBM. ALL QUESTIONS MUST BE REFERRED TO THE IBM PURCHASING DEPARTMENT.				IBM CONFIDENTIAL

DATE		EC NO.		PART NO.	
REL	DEC/07/04	J79495		39T0167	
DEVELOPMENT NO.			Q/M		
61 / 88					

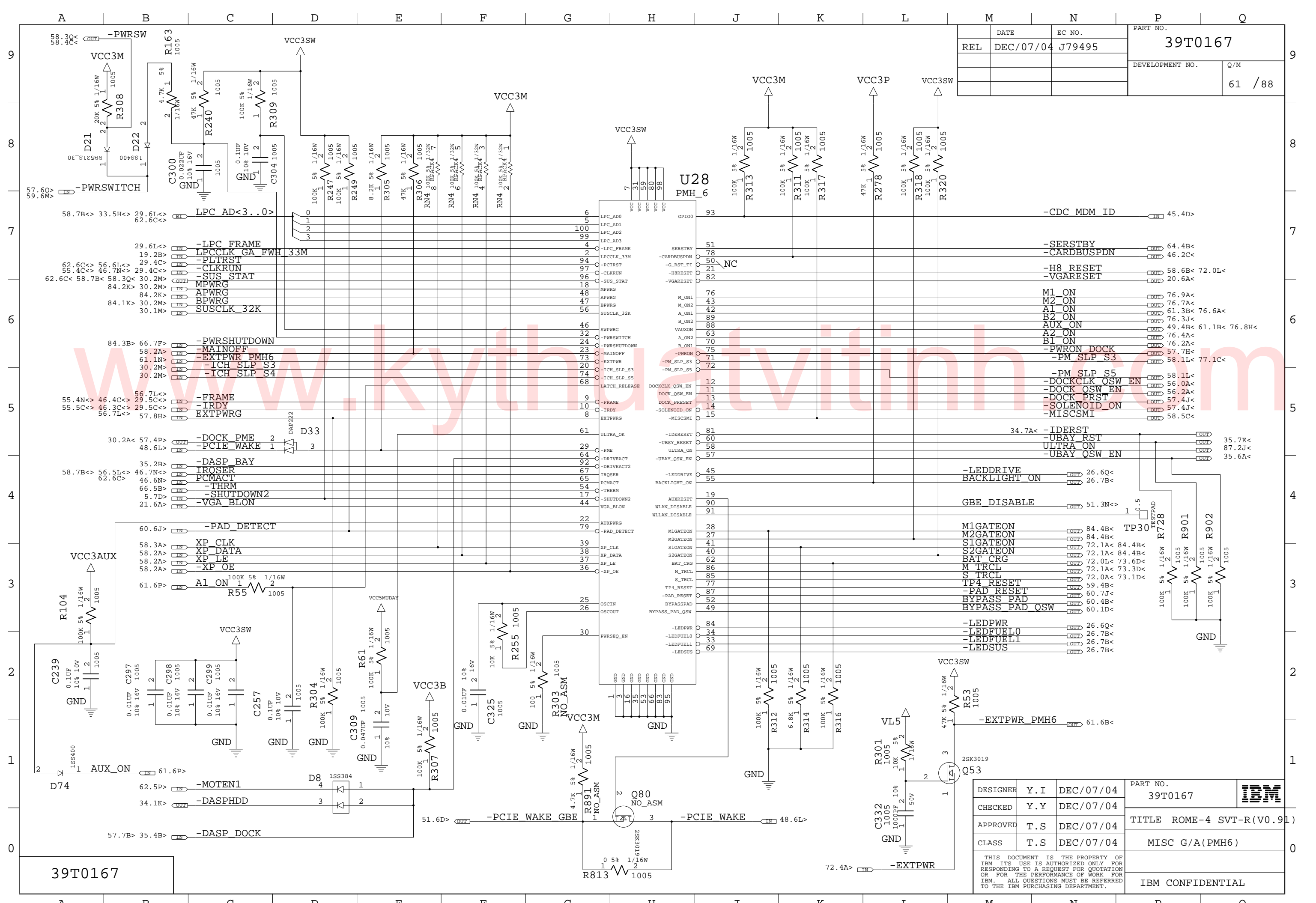

39T0167

DESIGNER	Y.I	DEC/07/04	PART NO.	39T0167	IBM
CHECKED	Y.Y	DEC/07/04	TITLE		
APPROVED	T.S	DEC/07/04	CLASS	MISC G/A (PMH6)	
THIS DOCUMENT IS THE PROPERTY OF IBM. ITS USE IS AUTHORIZED ONLY FOR RESPONDING TO A REQUEST FOR QUOTATION OR FOR THE PERFORMANCE OF WORK FOR IBM. ALL QUESTIONS MUST BE REFERRED TO THE IBM PURCHASING DEPARTMENT.				IBM CONFIDENTIAL	

DATE	EC NO.	PART NO.
REL DEC/07/04	J79495	39T0167
DEVELOPMENT NO.		Q/M
		62 / 88

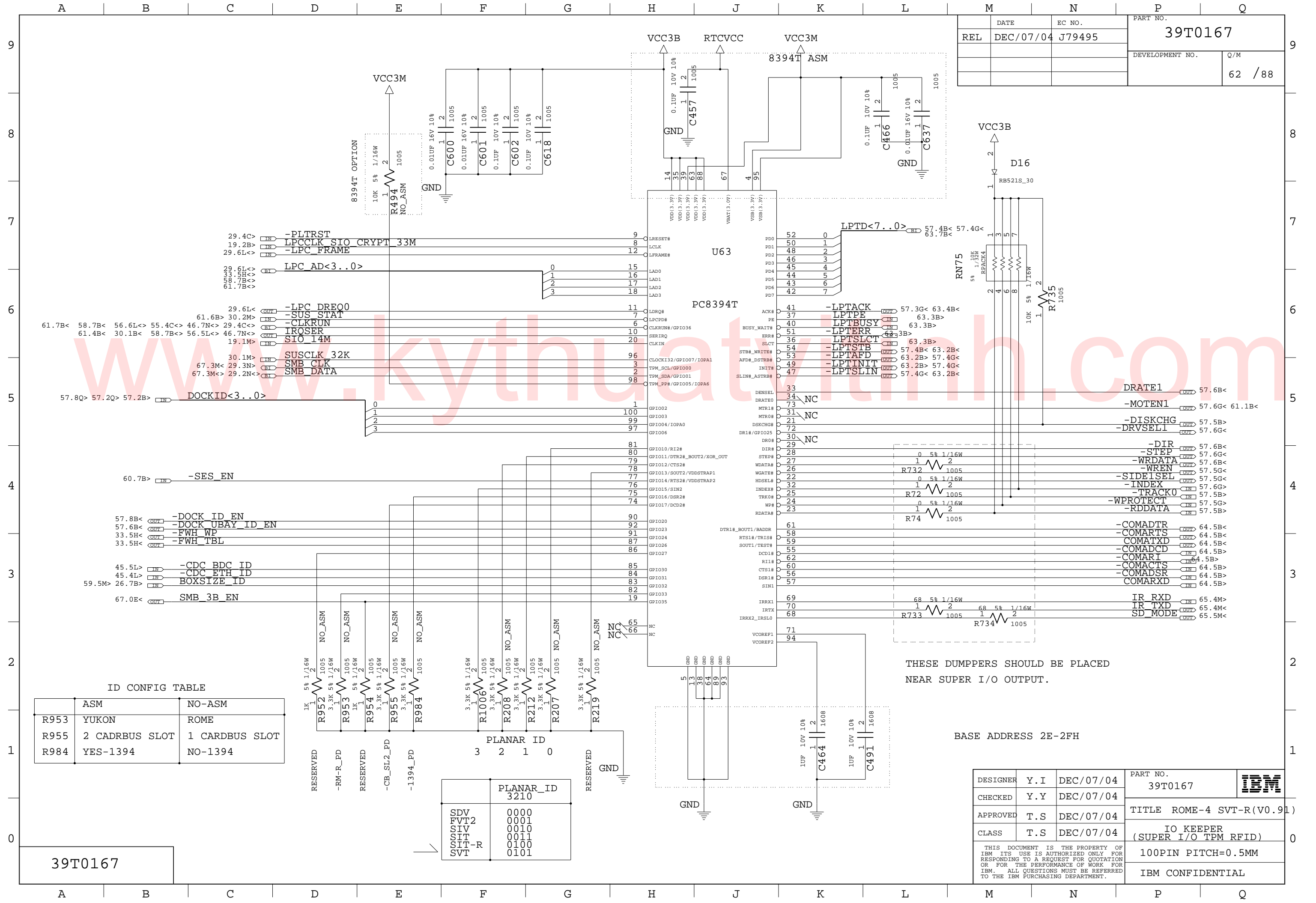

ID CONFIG TABLE

	ASM	NO-ASM
R953	YUKON	ROME
R955	2 CADDRBUS SLOT	1 CARDBUS SLOT
R984	YES-1394	NO-1394

PLANAR_ID	Value
3	0000
2	0001
1	0010
0	0011
	0100
	0101

THESE DUMPPERS SHOULD BE PLACED NEAR SUPER I/O OUTPUT.

BASE ADDRESS 2E-2FH

DESIGNER	Y.I	DEC/07/04	PART NO.	39T0167	
CHECKED	Y.Y	DEC/07/04	TITLE ROME-4 SVT-R(V0.91)		
APPROVED	T.S	DEC/07/04	IO KEEPER (SUPER I/O TPM RFID)		
CLASS	T.S	DEC/07/04	100PIN PITCH=0.5MM		
THIS DOCUMENT IS THE PROPERTY OF IBM ITS USE IS AUTHORIZED ONLY FOR RESPONDING TO A REQUEST FOR QUOTATION OR FOR THE PERFORMANCE OF WORK FOR IBM. ALL QUESTIONS MUST BE REFERRED TO THE IBM PURCHASING DEPARTMENT.					IBM CONFIDENTIAL

39T0167

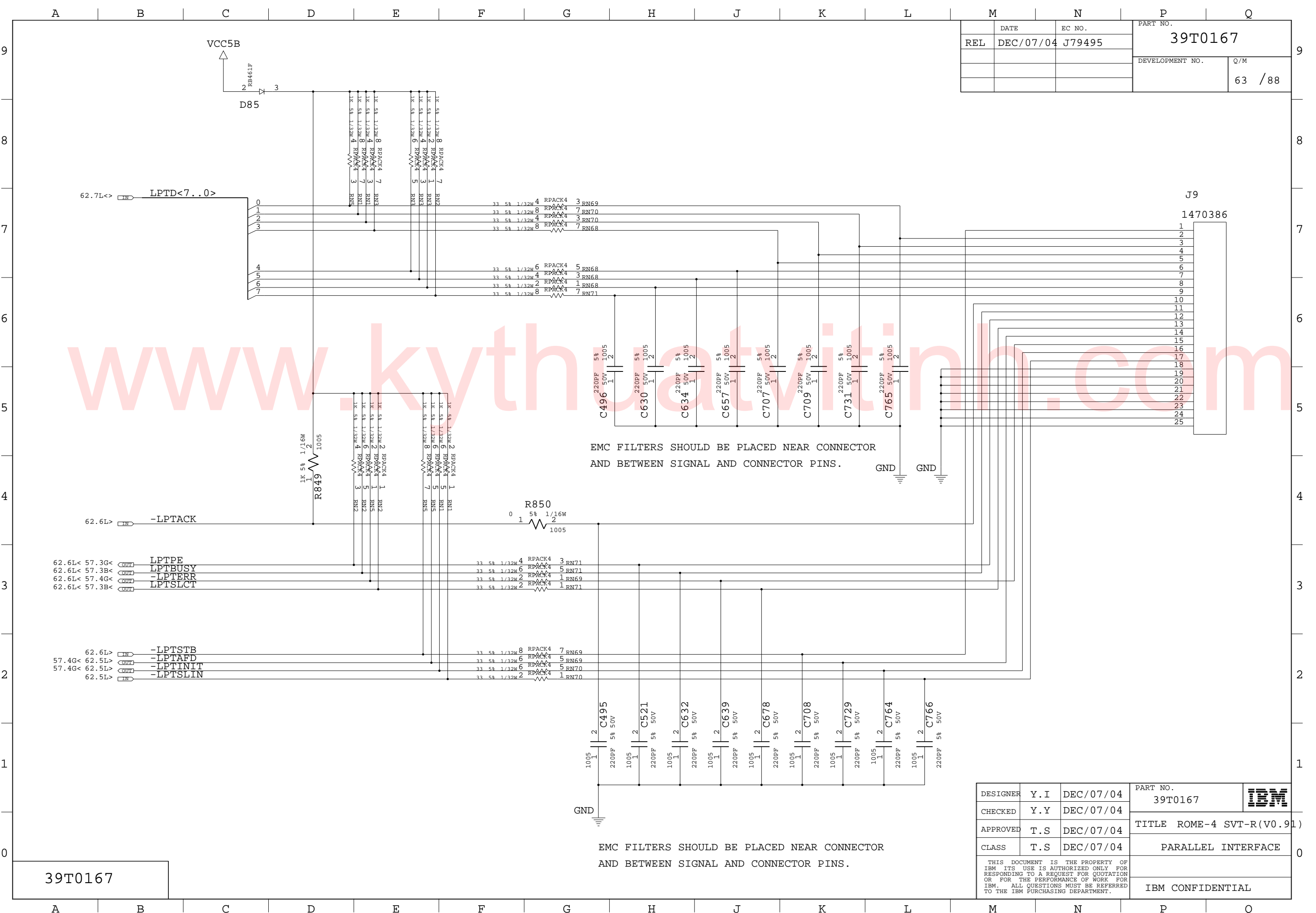

REL	DATE	EC NO.	PART NO.
	DEC/07/04	J79495	39T0167
			DEVELOPMENT NO.
			Q/M
			63 / 88

EMC FILTERS SHOULD BE PLACED NEAR CONNECTOR AND BETWEEN SIGNAL AND CONNECTOR PINS.

EMC FILTERS SHOULD BE PLACED NEAR CONNECTOR AND BETWEEN SIGNAL AND CONNECTOR PINS.

39T0167

DESIGNER	Y.I	DEC/07/04	PART NO.	IBM
CHECKED	Y.Y	DEC/07/04	39T0167	
APPROVED	T.S	DEC/07/04	TITLE ROME-4 SVT-R(V0.91)	
CLASS	T.S	DEC/07/04	PARALLEL INTERFACE	
THIS DOCUMENT IS THE PROPERTY OF IBM ITS USE IS AUTHORIZED ONLY FOR RESPONDING TO A REQUEST FOR QUOTATION OR FOR THE PERFORMANCE OF WORK FOR IBM. ALL QUESTIONS MUST BE REFERRED TO THE IBM PURCHASING DEPARTMENT.				IBM CONFIDENTIAL

REL	DATE DEC/07/04	EC NO. J79495	PART NO. 39T0167
			DEVELOPMENT NO. Q/M 64 /88

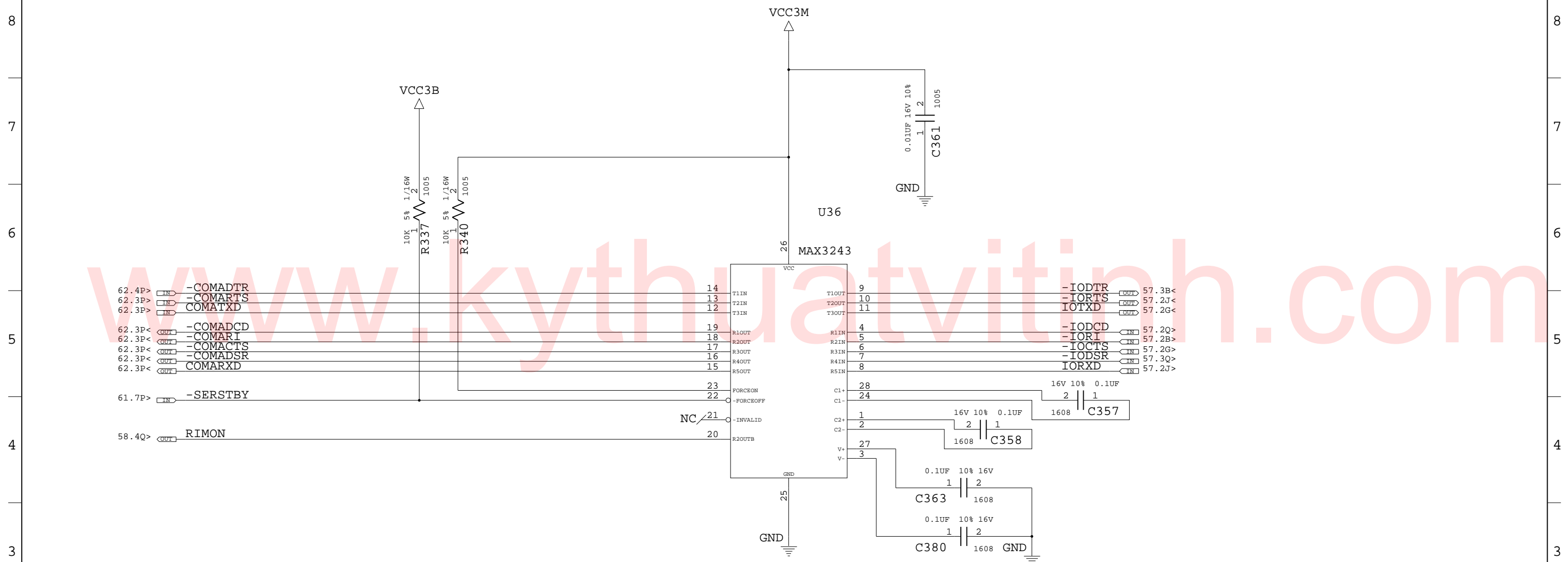

R1IN/R2IN/R3IN/R5IN HAVE INTERNAL PULLDOWN(5K OHM).
 DO NOT WIRE SIGNALS UNDER PINS (1/2/3/24/25/26/27/28)
 CHARGE PUMP CAPACITOR SHOULD BE PLACED NEAR PINS(1/2/3/24/27/28)
 ADD GND SHILED UNDER CHARGE PUMP CIRCUIT TO
 PROTECT POWER LINE NOISE
 CAPACITORS FOR CHARGE PUMP SHOULD BE USED TYPE B AND LOW ESR TYPE.

	NORMAL MODE	POWER DOWN MODE	AUTO POWER DOWN MODE
FORCEON	HIGH	DO NOT CARE	LOW
FOCEOFF	HIGH	LOW	HIGH

39T0167

DESIGNER	Y.I	DEC/07/04	PART NO. 39T0167	IBM
CHECKED	Y.Y	DEC/07/04	TITLE ROME-4 SVT-R(V0.91)	
APPROVED	T.S	DEC/07/04	SERIAL INTERFACE	
CLASS	T.S	DEC/07/04		
THIS DOCUMENT IS THE PROPERTY OF IBM ITS USE IS AUTHORIZED ONLY FOR RESPONDING TO A REQUEST FOR QUOTATION OR FOR THE PERFORMANCE OF WORK FOR IBM. ALL QUESTIONS MUST BE REFERRED TO THE IBM PURCHASING DEPARTMENT.				IBM CONFIDENTIAL

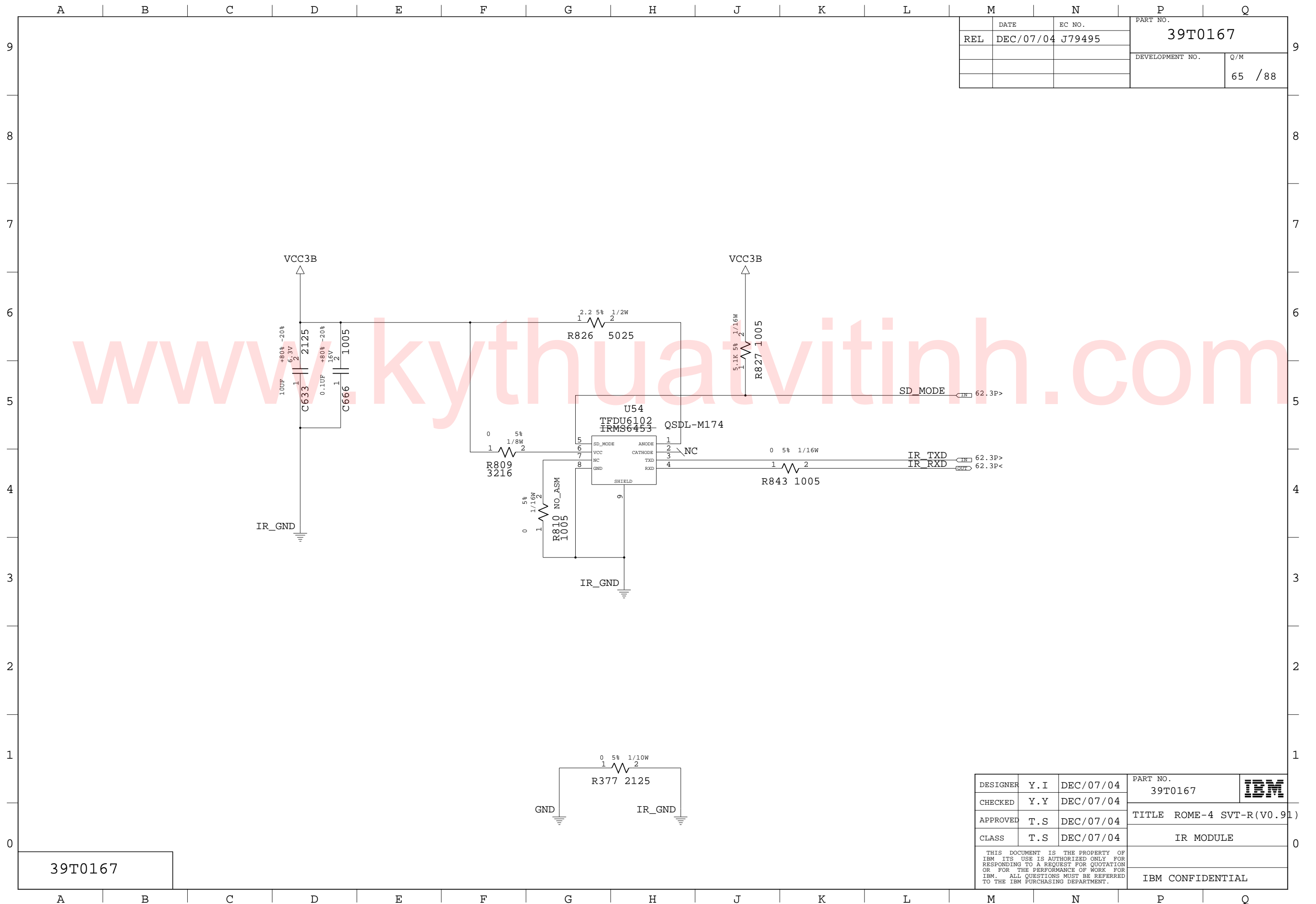

	DATE	EC NO.	PART NO.	
REL	DEC/07/04	J79495	39T0167	
			DEVELOPMENT NO.	Q/M
				65 / 88

39T0167

DESIGNER	Y. I	DEC/07/04	PART NO.	39T0167	IBM
CHECKED	Y. Y	DEC/07/04			
APPROVED	T. S	DEC/07/04	TITLE ROME-4 SVT-R (V0.91)		
CLASS	T. S	DEC/07/04	IR MODULE		
THIS DOCUMENT IS THE PROPERTY OF IBM. ITS USE IS AUTHORIZED ONLY FOR RESPONDING TO A REQUEST FOR QUOTATION OR FOR THE PERFORMANCE OF WORK FOR IBM. ALL QUESTIONS MUST BE REFERRED TO THE IBM PURCHASING DEPARTMENT.				IBM CONFIDENTIAL	

DATE	EC NO.	PART NO.
REL DEC/07/04	J79495	39T0167
DEVELOPMENT NO.		Q/M
		66 / 88

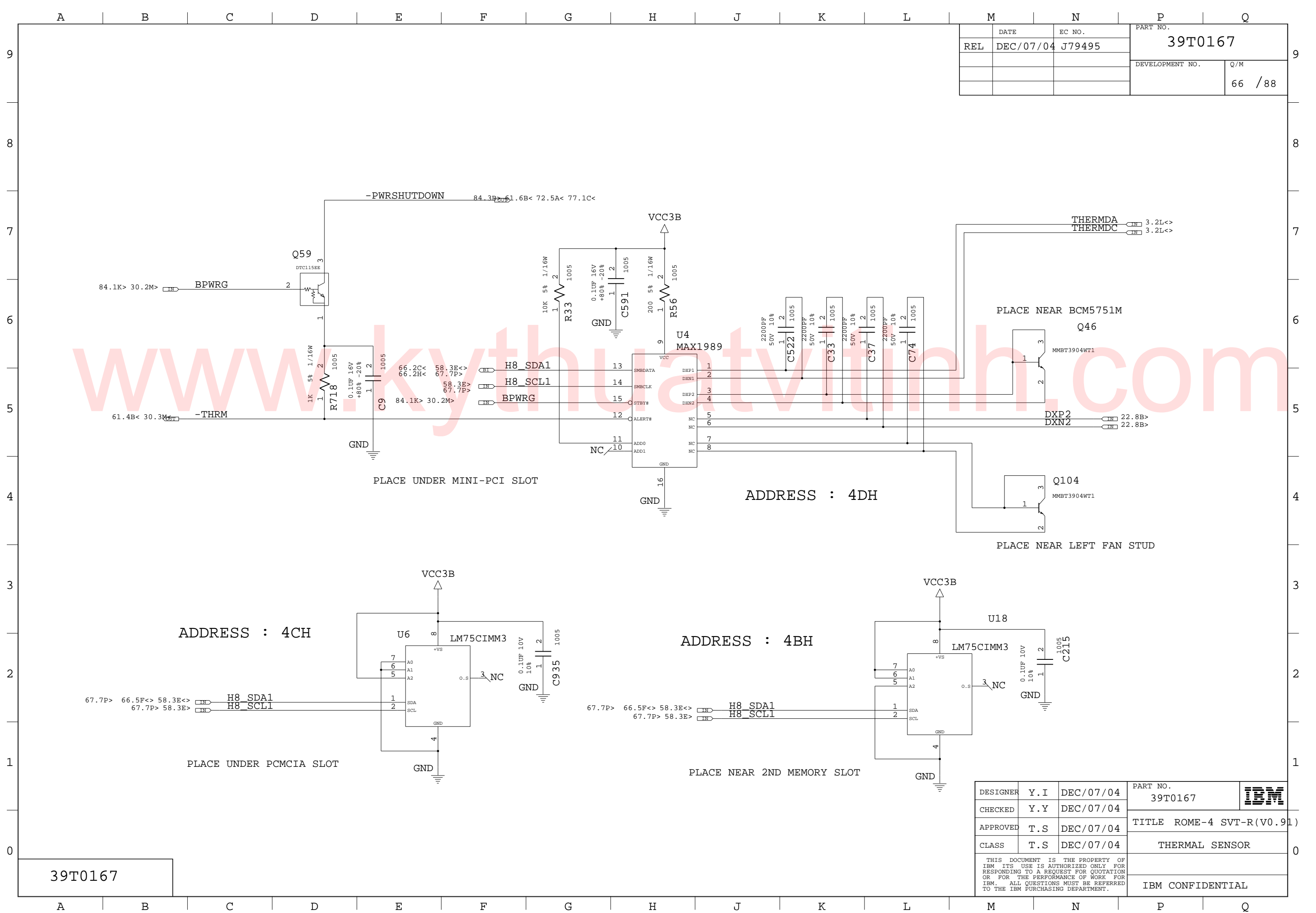

PLACE UNDER MINI-PCI SLOT

ADDRESS : 4DH

PLACE NEAR LEFT FAN STUD

ADDRESS : 4CH

PLACE UNDER PCMCIA SLOT

ADDRESS : 4BH

PLACE NEAR 2ND MEMORY SLOT

39T0167

DESIGNER	Y.I	DEC/07/04	PART NO.	39T0167	IBM
CHECKED	Y.Y	DEC/07/04			
APPROVED	T.S	DEC/07/04	TITLE ROME-4 SVT-R(V0.91)		
CLASS	T.S	DEC/07/04	THERMAL SENSOR		
THIS DOCUMENT IS THE PROPERTY OF IBM ITS USE IS AUTHORIZED ONLY FOR RESPONDING TO A REQUEST FOR QUOTATION OR FOR THE PERFORMANCE OF WORK FOR IBM. ALL QUESTIONS MUST BE REFERRED TO THE IBM PURCHASING DEPARTMENT.				IBM CONFIDENTIAL	

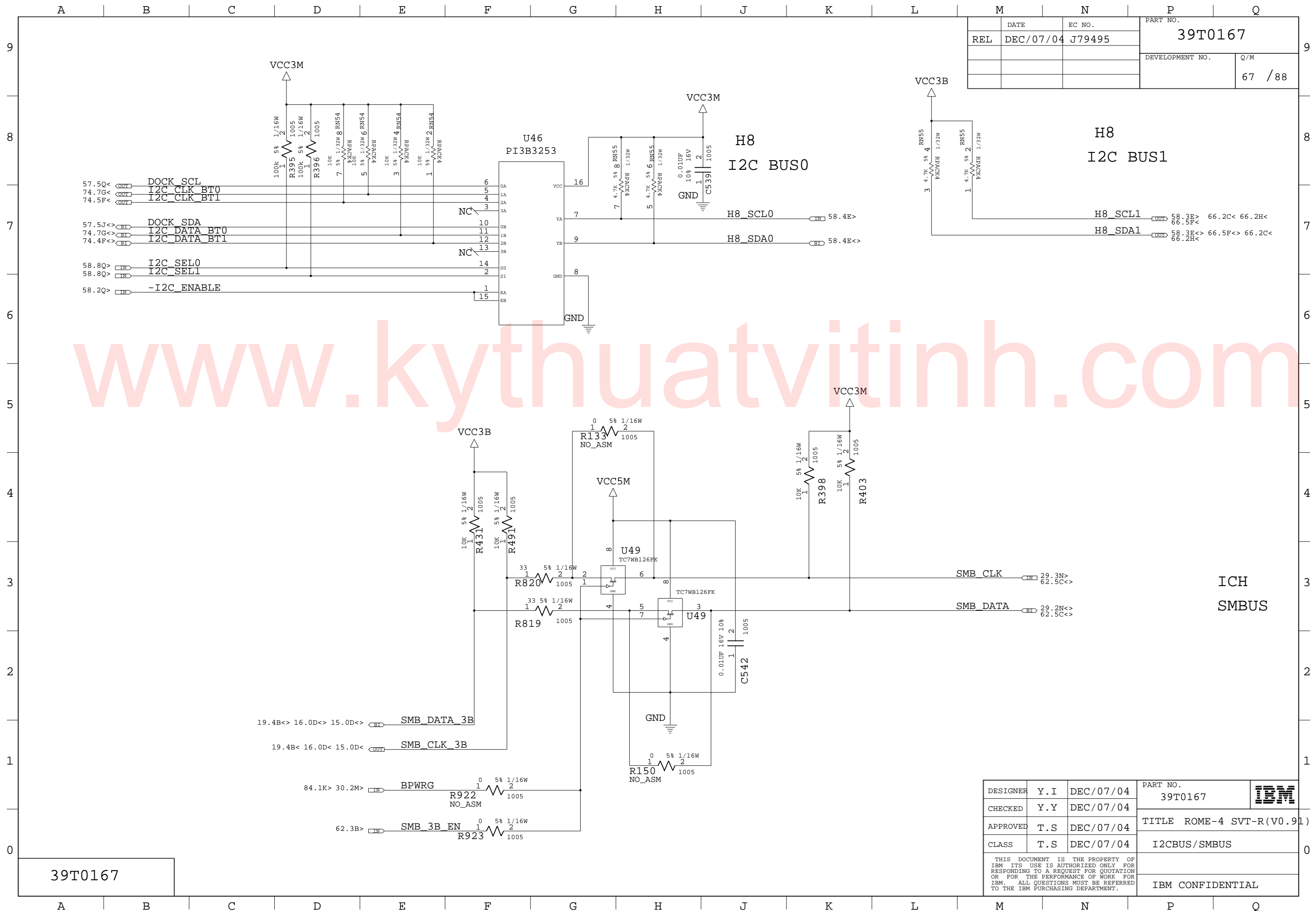

DATE	EC NO.	PART NO.	
REL DEC/07/04	J79495	39T0167	
		DEVELOPMENT NO.	Q/M
			67 / 88

DESIGNER	Y.I	DEC/07/04	PART NO.	39T0167	IBM
CHECKED	Y.Y	DEC/07/04			
APPROVED	T.S	DEC/07/04	TITLE ROME-4 SVT-R(V0.91)		
CLASS	T.S	DEC/07/04	I2CBUS/SMBUS		
THIS DOCUMENT IS THE PROPERTY OF IBM ITS USE IS AUTHORIZED ONLY FOR RESPONDING TO A REQUEST FOR QUOTATION OR FOR THE PERFORMANCE OF WORK FOR IBM. ALL QUESTIONS MUST BE REFERRED TO THE IBM PURCHASING DEPARTMENT.					IBM CONFIDENTIAL

39T0167

	DATE	EC NO.	PART NO.
REL	DEC/07/04	J79495	39T0167
			DEVELOPMENT NO.
			Q/M
			68 / 88

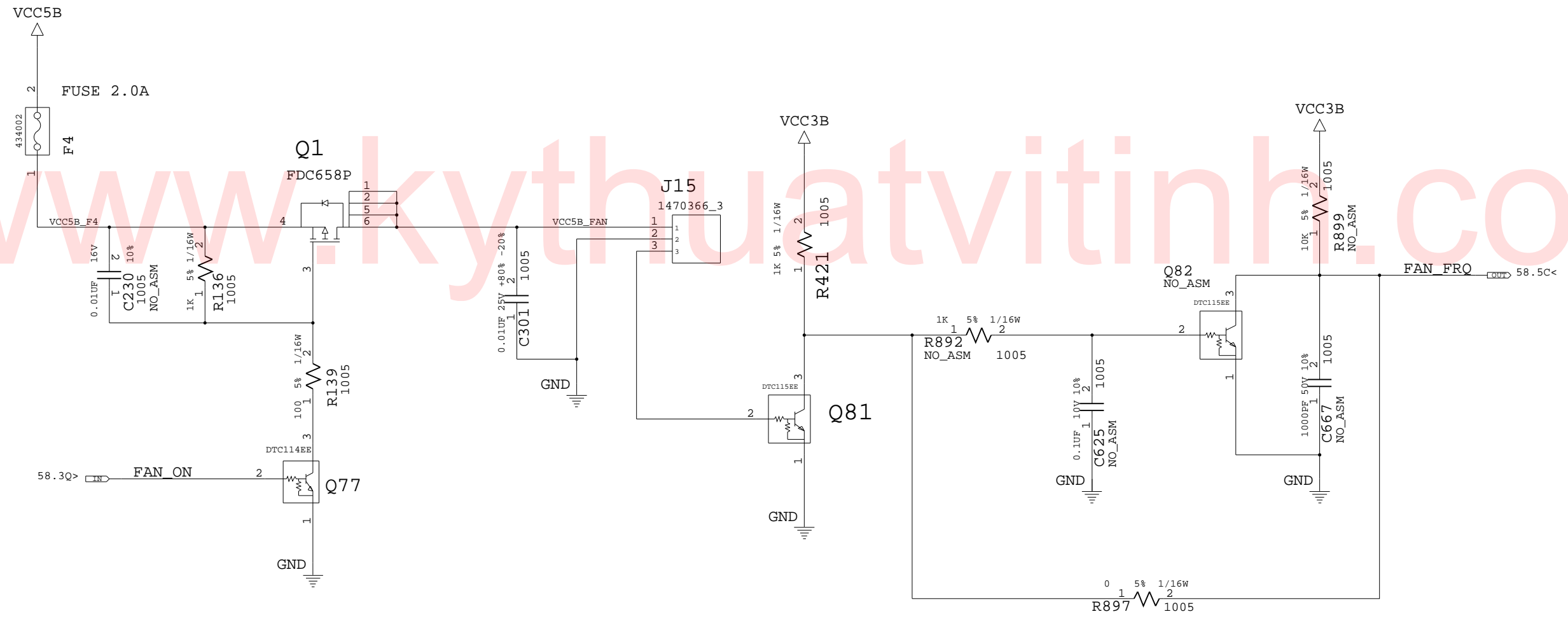

39T0167

DESIGNER	Y. I	DEC/07/04	PART NO.	39T0167	IBM
CHECKED	Y. Y	DEC/07/04			
APPROVED	T. S	DEC/07/04	TITLE ROME-4 SVT-R (V0.91)		
CLASS	T. S	DEC/07/04	FAN CONNECTOR		
THIS DOCUMENT IS THE PROPERTY OF IBM ITS USE IS AUTHORIZED ONLY FOR RESPONDING TO A REQUEST FOR QUOTATION OR FOR THE PERFORMANCE OF WORK FOR IBM. ALL QUESTIONS MUST BE REFERRED TO THE IBM PURCHASING DEPARTMENT.				IBM CONFIDENTIAL	

DATE	EC NO.	PART NO.
REL DEC/07/04	J79495	39T0167
		DEVELOPMENT NO. Q/M
		69 / 88

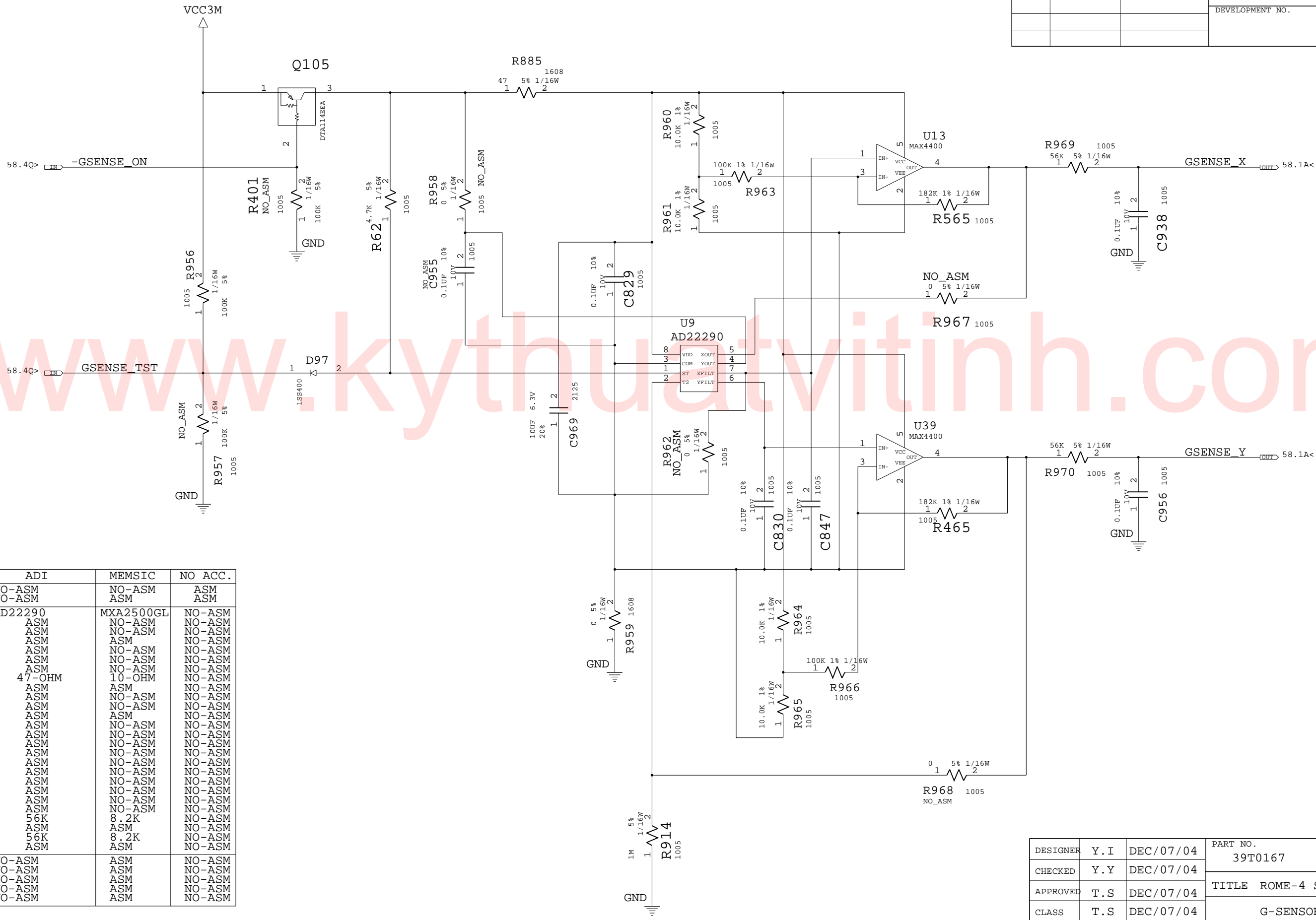

	ADI	MEMSIC	NO ACC.
R401	NO-ASM	NO-ASM	ASM
R957	NO-ASM	ASM	ASM
U9	AD22290	MXA2500GL	NO-ASM
U13	ASM	NO-ASM	NO-ASM
U39	ASM	NO-ASM	NO-ASM
Q105	ASM	NO-ASM	NO-ASM
D97	ASM	NO-ASM	NO-ASM
R956	ASM	NO-ASM	NO-ASM
R958	ASM	NO-ASM	NO-ASM
R885	ASM	10-OHM	NO-ASM
C829	ASM	ASM	NO-ASM
C955	ASM	NO-ASM	NO-ASM
C969	ASM	NO-ASM	NO-ASM
C830	ASM	NO-ASM	NO-ASM
C847	ASM	NO-ASM	NO-ASM
C956	ASM	NO-ASM	NO-ASM
C938	ASM	NO-ASM	NO-ASM
R961	ASM	NO-ASM	NO-ASM
R963	ASM	NO-ASM	NO-ASM
R965	ASM	NO-ASM	NO-ASM
R966	ASM	NO-ASM	NO-ASM
R967	ASM	NO-ASM	NO-ASM
R968	ASM	NO-ASM	NO-ASM
R969	ASM	NO-ASM	NO-ASM
R970	ASM	NO-ASM	NO-ASM
R914	ASM	NO-ASM	NO-ASM
R955	NO-ASM	ASM	NO-ASM
C955	NO-ASM	ASM	NO-ASM
R967	NO-ASM	ASM	NO-ASM
R968	NO-ASM	ASM	NO-ASM

39T0167

DESIGNER	Y.I	DEC/07/04	PART NO.	39T0167	IBM
CHECKED	Y.Y	DEC/07/04			
APPROVED	T.S	DEC/07/04	TITLE ROME-4 SVT-R(V0.91)		
CLASS	T.S	DEC/07/04	G-SENSOR		
THIS DOCUMENT IS THE PROPERTY OF IBM. ITS USE IS AUTHORIZED ONLY FOR RESPONDING TO A REQUEST FOR QUOTATION OR FOR THE PERFORMANCE OF WORK FOR IBM. ALL QUESTIONS MUST BE REFERRED TO THE IBM PURCHASING DEPARTMENT.					IBM CONFIDENTIAL

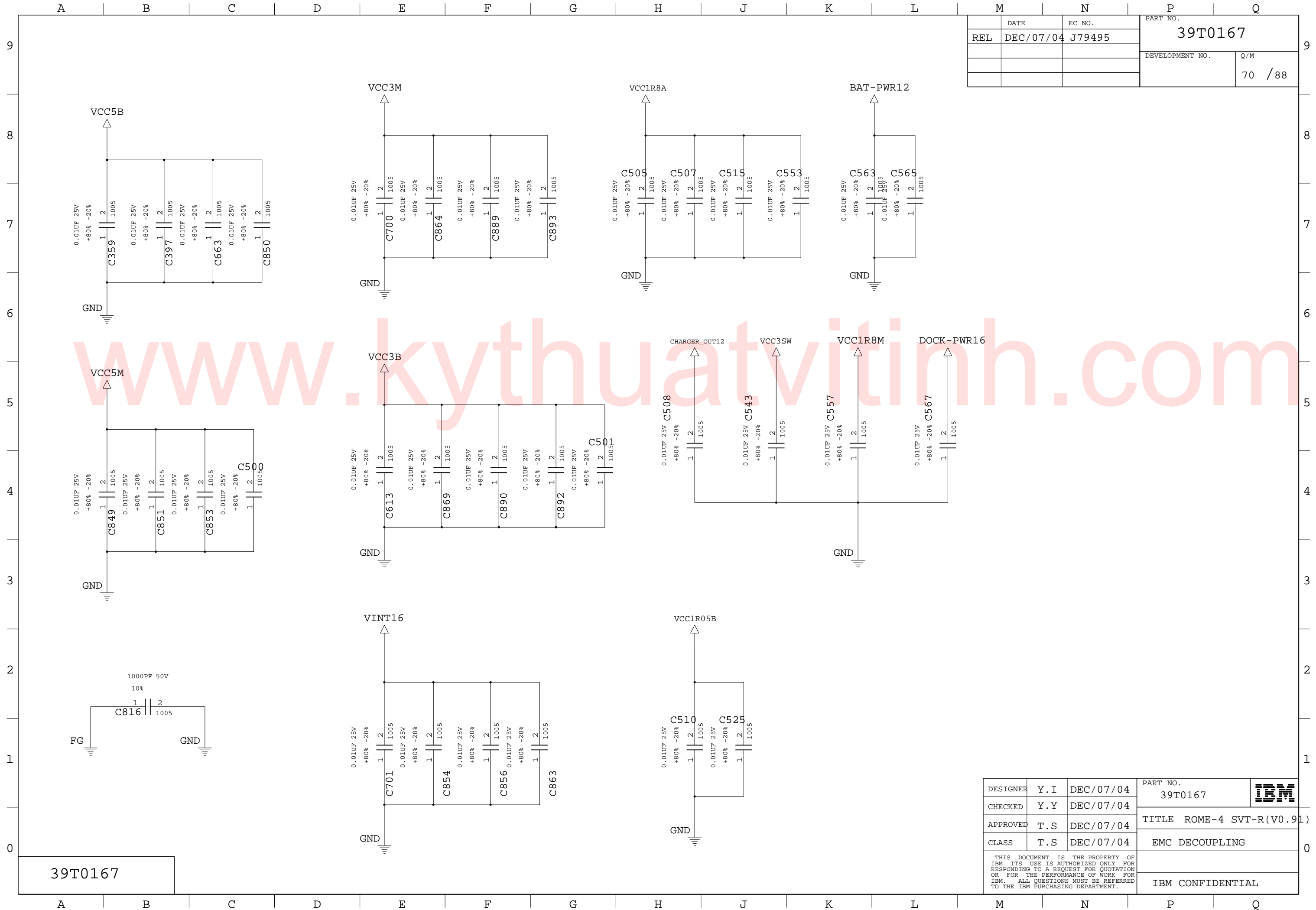

	DATE	EC NO.	PART NO.	
REL	DEC/07/04	J79495	39T0167	
			DEVELOPMENT NO.	Q/M
				70 / 88

39T0167

DESIGNER	Y.I	DEC/07/04	PART NO.	39T0167	
CHECKED	Y.Y	DEC/07/04			
APPROVED	T.S	DEC/07/04	TITLE ROME-4 SVT-R(V0.91)		
CLASS	T.S	DEC/07/04	EMC DECOUPLING		
THIS DOCUMENT IS THE PROPERTY OF IBM. ITS USE IS AUTHORIZED ONLY FOR RESPONDING TO A REQUEST FOR QUOTATION OR FOR THE PERFORMANCE OF WORK FOR IBM. ALL QUESTIONS MUST BE REFERRED TO THE IBM PURCHASING DEPARTMENT.				IBM CONFIDENTIAL	

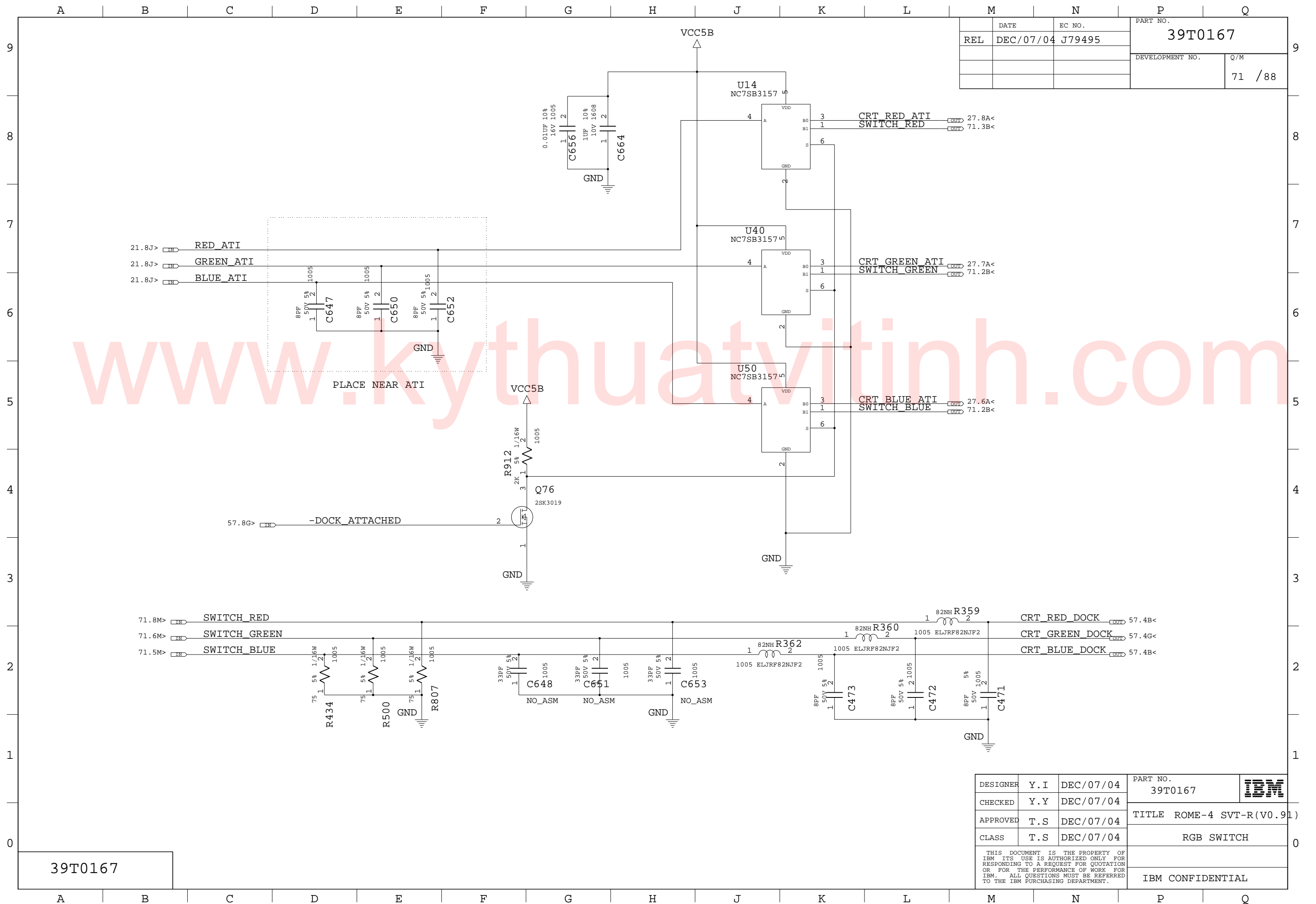

REL	DATE	EC NO.	PART NO.
	DEC/07/04	J79495	39T0167
			DEVELOPMENT NO.
			Q/M
			71 / 88

DESIGNER	Y. I	DEC/07/04	PART NO.	39T0167	IBM
CHECKED	Y. Y	DEC/07/04			
APPROVED	T. S	DEC/07/04	TITLE ROME-4 SVT-R(V0.91)		
CLASS	T. S	DEC/07/04	RGB SWITCH		
THIS DOCUMENT IS THE PROPERTY OF IBM. ITS USE IS AUTHORIZED ONLY FOR RESPONDING TO A REQUEST FOR QUOTATION OR FOR THE PERFORMANCE OF WORK FOR IBM. ALL QUESTIONS MUST BE REFERRED TO THE IBM PURCHASING DEPARTMENT.				IBM CONFIDENTIAL	

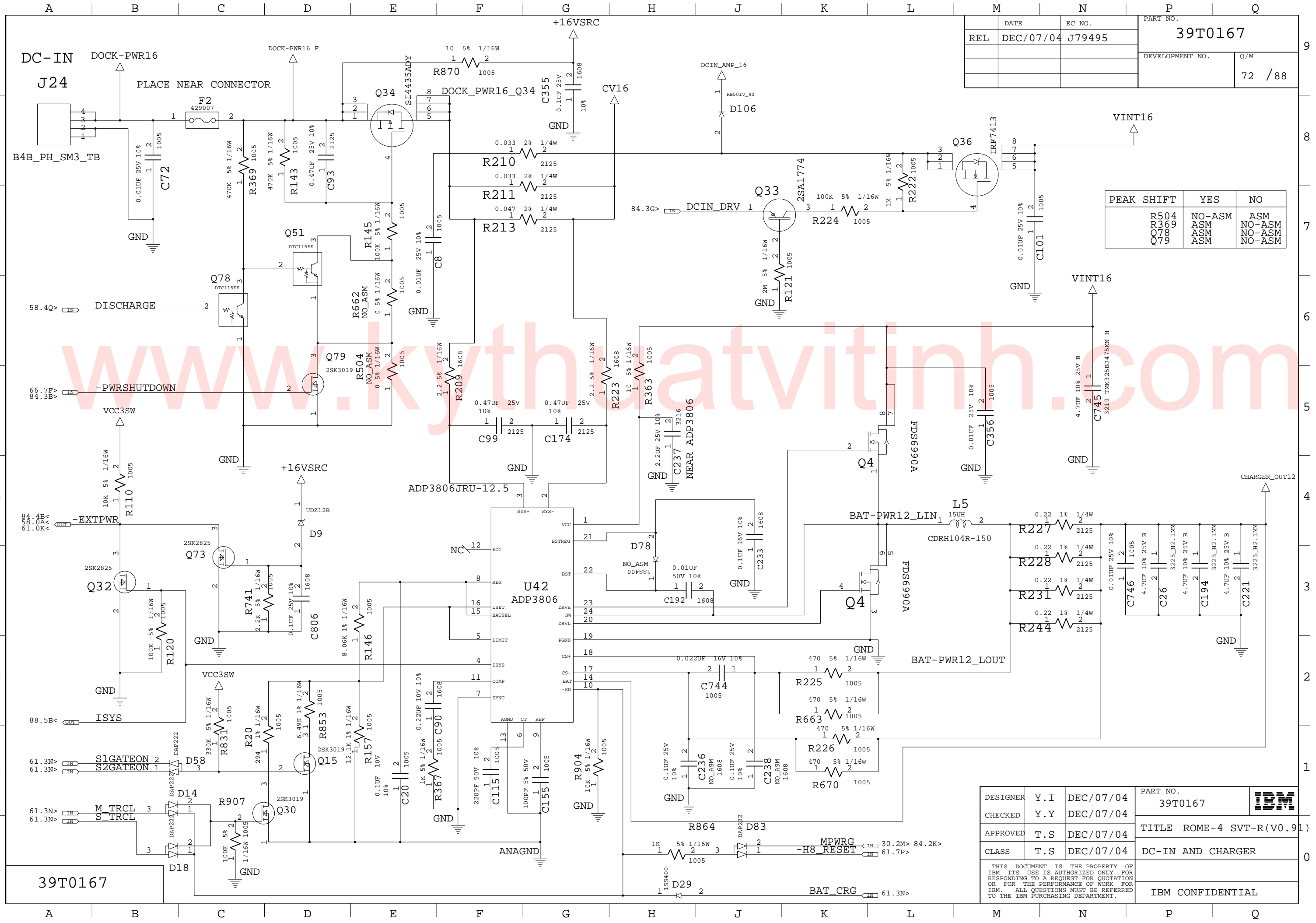

REL	DATE	DEC/07/04	EC NO.	J79495	PART NO.	39T0167	
					DEVELOPMENT NO.	Q/M	
						72 / 88	

PEAK SHIFT	YES	NO
R504	NO-ASM	ASM
R369	ASM	NO-ASM
Q78	ASM	NO-ASM
Q79	ASM	NO-ASM

DESIGNER	Y.I	DEC/07/04	PART NO.	39T0167	
CHECKED	Y.Y	DEC/07/04			
APPROVED	T.S	DEC/07/04	TITLE ROME-4 SVT-R (V0.91)		
CLASS	T.S	DEC/07/04	DC-IN AND CHARGER		
THIS DOCUMENT IS THE PROPERTY OF IBM. ITS USE IS AUTHORIZED ONLY FOR RESPONDING TO A REQUEST FOR QUOTATION OR FOR THE PERFORMANCE OF WORK FOR IBM. ALL QUESTIONS MUST BE REFERRED TO THE IBM PURCHASING DEPARTMENT.					IBM CONFIDENTIAL

39T0167

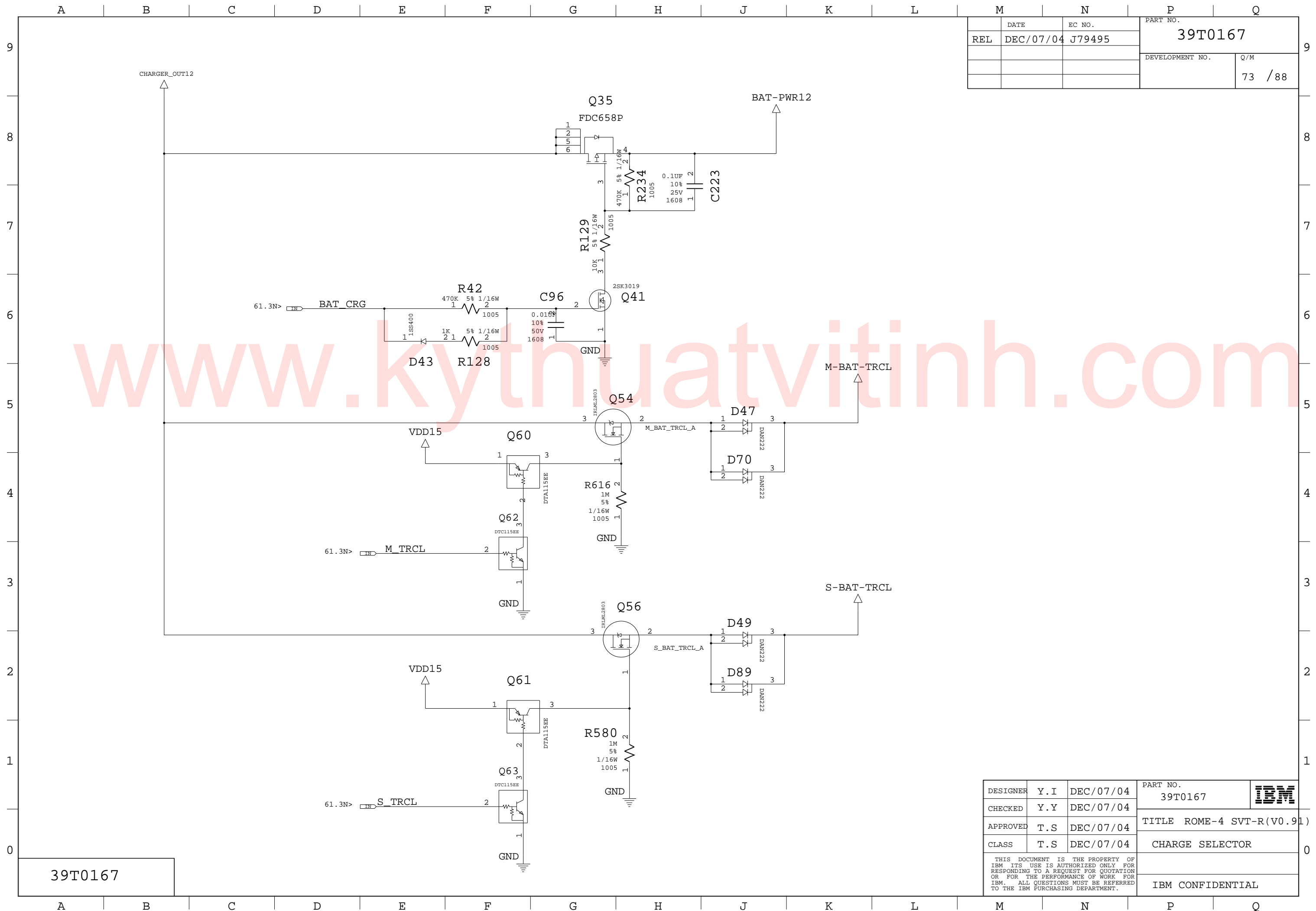

	DATE	EC NO.	PART NO.
REL	DEC/07/04	J79495	39T0167
			DEVELOPMENT NO.
			Q/M
			73 / 88

39T0167

DESIGNER	Y. I	DEC/07/04	PART NO.	39T0167	
CHECKED	Y. Y	DEC/07/04			
APPROVED	T. S	DEC/07/04	TITLE ROME-4 SVT-R (V0.91)		
CLASS	T. S	DEC/07/04	CHARGE SELECTOR		
THIS DOCUMENT IS THE PROPERTY OF IBM. ITS USE IS AUTHORIZED ONLY FOR RESPONDING TO A REQUEST FOR QUOTATION OR FOR THE PERFORMANCE OF WORK FOR IBM. ALL QUESTIONS MUST BE REFERRED TO THE IBM PURCHASING DEPARTMENT.				IBM CONFIDENTIAL	

DATE	EC NO.	PART NO.
REL DEC/07/04	J79495	39T0167
DEVELOPMENT NO.		Q/M
		74 / 88

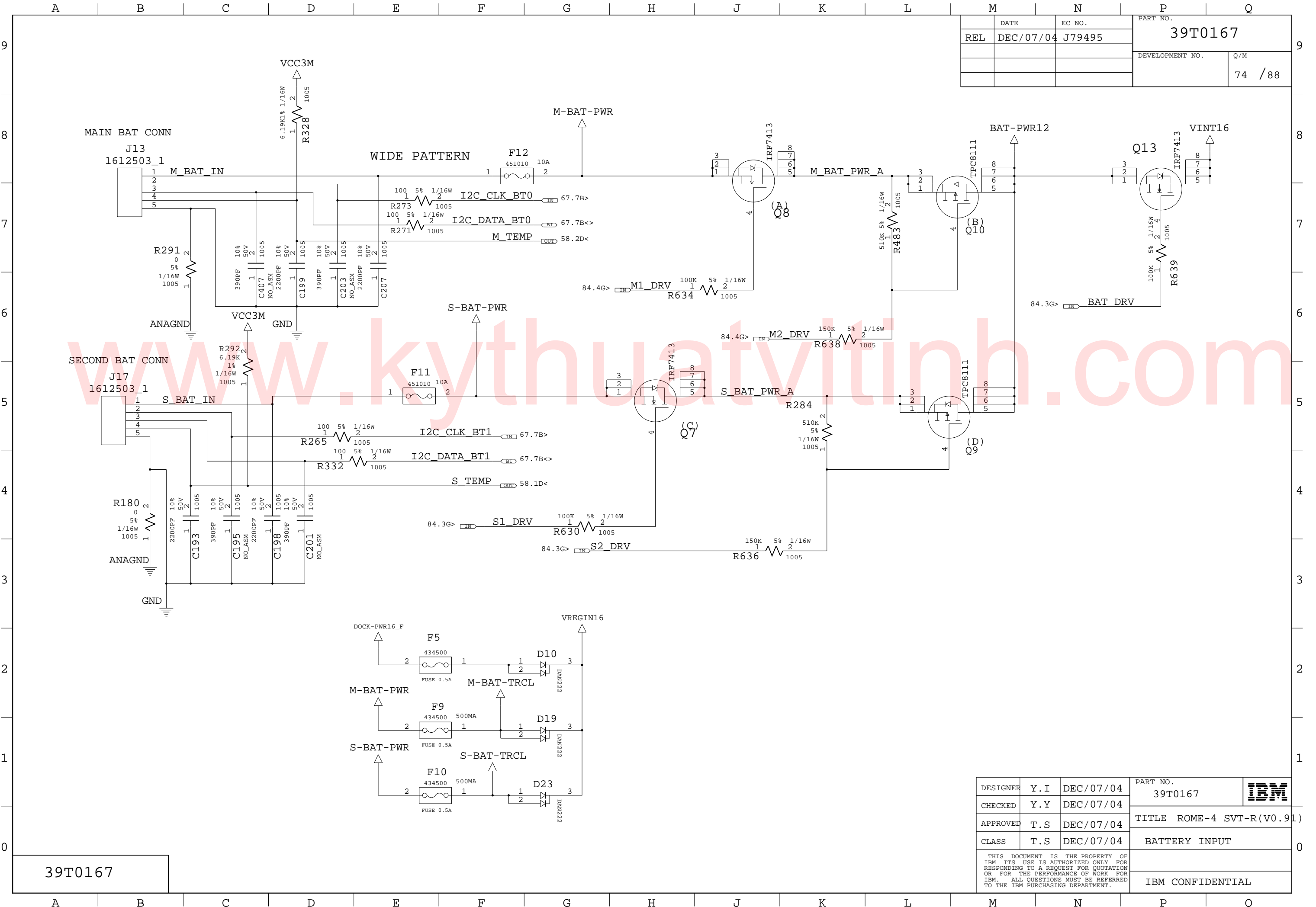

39T0167

DESIGNER	Y.I	DEC/07/04	PART NO.	39T0167	
CHECKED	Y.Y	DEC/07/04			
APPROVED	T.S	DEC/07/04	TITLE ROME-4 SVT-R(V0.91)		
CLASS	T.S	DEC/07/04	BATTERY INPUT		
THIS DOCUMENT IS THE PROPERTY OF IBM ITS USE IS AUTHORIZED ONLY FOR RESPONDING TO A REQUEST FOR QUOTATION OR FOR THE PERFORMANCE OF WORK FOR IBM. ALL QUESTIONS MUST BE REFERRED TO THE IBM PURCHASING DEPARTMENT.				IBM CONFIDENTIAL	

	DATE	EC NO.	PART NO.	
REL	DEC/07/04	J79495	39T0167	
			DEVELOPMENT NO.	Q/M
				75 / 88

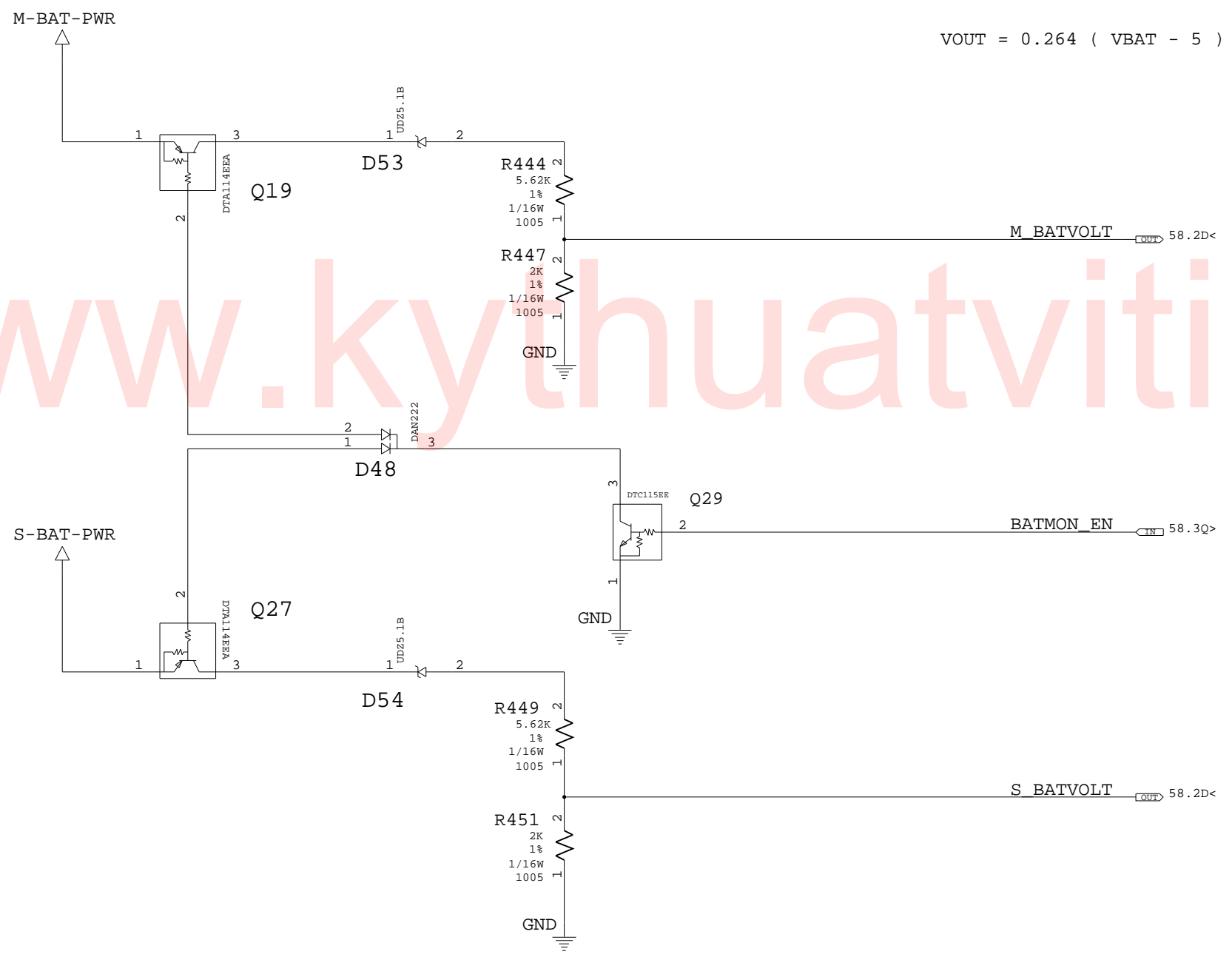

www.kyathuatvithinh.com

39T0167

DESIGNER	Y. I	DEC/07/04	PART NO.	39T0167	IBM
CHECKED	Y. Y	DEC/07/04			
APPROVED	T. S	DEC/07/04	TITLE ROME-4 SVT-R (V0.91)		
CLASS	T. S	DEC/07/04	BATTERY MONITOR		
THIS DOCUMENT IS THE PROPERTY OF IBM. ITS USE IS AUTHORIZED ONLY FOR RESPONDING TO A REQUEST FOR QUOTATION OR FOR THE PERFORMANCE OF WORK FOR IBM. ALL QUESTIONS MUST BE REFERRED TO THE IBM PURCHASING DEPARTMENT.				IBM CONFIDENTIAL	

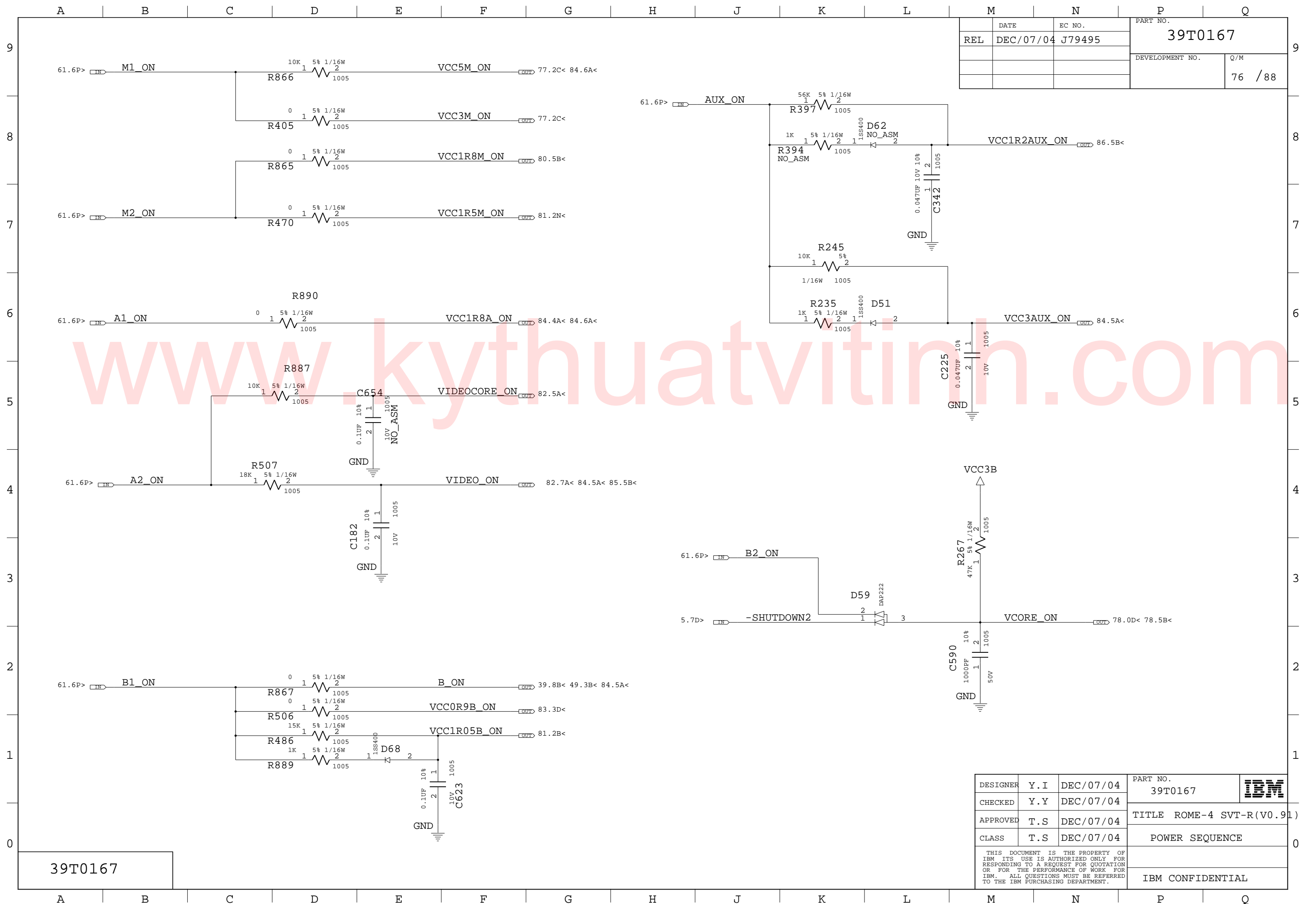

DATE	EC NO.	PART NO.
REL DEC/07/04	J79495	39T0167
DEVELOPMENT NO.		Q/M
		76 / 88

39T0167

DESIGNER	Y.I	DEC/07/04	PART NO.	39T0167	IBM
CHECKED	Y.Y	DEC/07/04			
APPROVED	T.S	DEC/07/04	TITLE ROME-4 SVT-R(V0.91)		
CLASS	T.S	DEC/07/04	POWER SEQUENCE		
THIS DOCUMENT IS THE PROPERTY OF IBM. ITS USE IS AUTHORIZED ONLY FOR RESPONDING TO A REQUEST FOR QUOTATION OR FOR THE PERFORMANCE OF WORK FOR IBM. ALL QUESTIONS MUST BE REFERRED TO THE IBM PURCHASING DEPARTMENT.				IBM CONFIDENTIAL	

A B C D E F G H J K L M N P Q

VCC3M TABLE 1/1

VCC3M	4.0A	5.0A
R987	NO-ASM	ASM
L4	CDRH104R_10UH_4R4A	CDRH104R_5R2UH_5R5A
Q100	NO-ASM	ASM
C217	NO-ASM	ASM

REL	DATE	EC NO.	PART NO.
	DEC/07/04	J79495	39T0167
			DEVELOPMENT NO.
			Q/M
			77 / 88

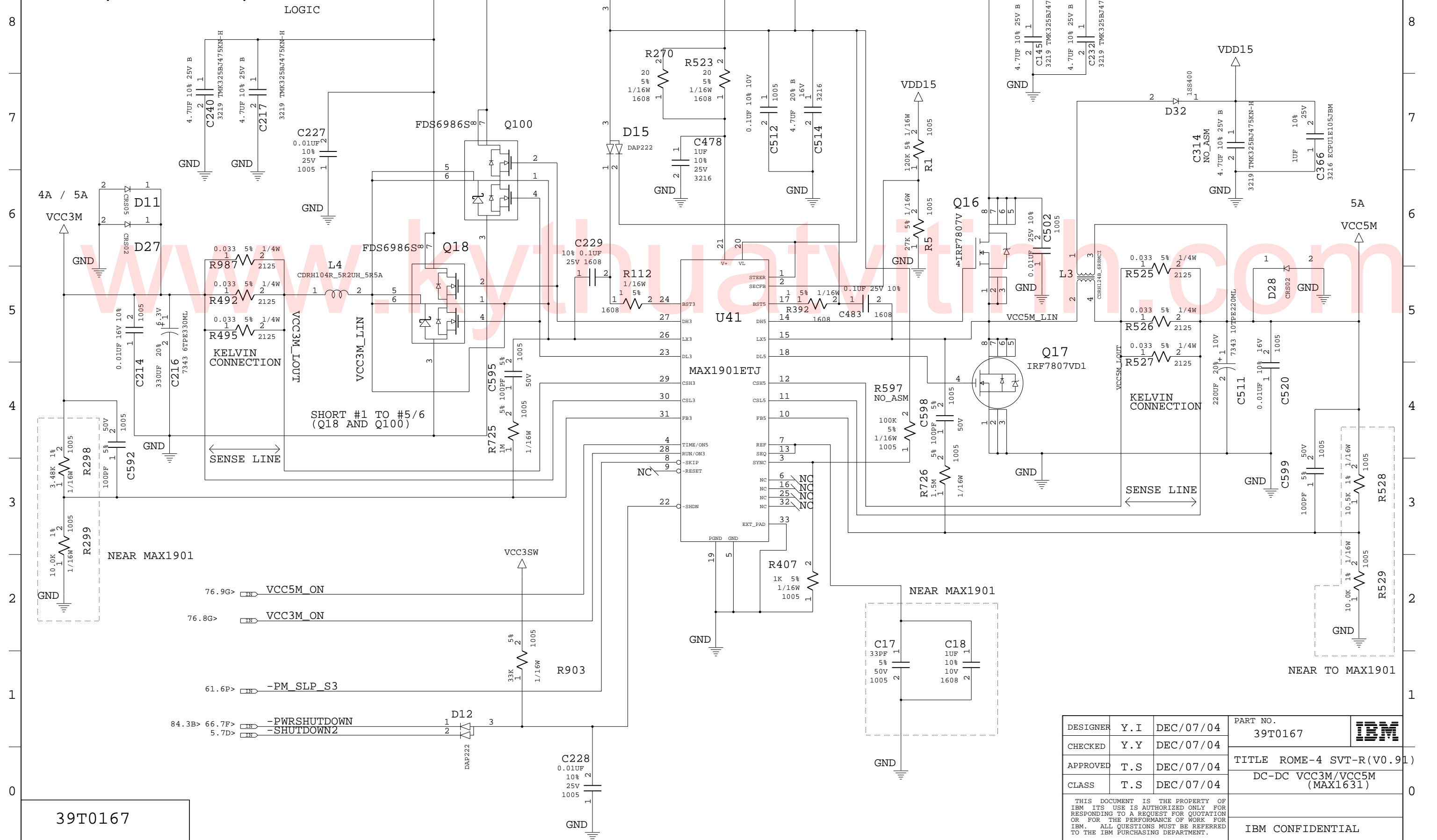

39T0167

DESIGNER	Y.I	DEC/07/04	PART NO.	39T0167	
CHECKED	Y.Y	DEC/07/04			
APPROVED	T.S	DEC/07/04	TITLE ROME-4 SVT-R (V0.91)		
CLASS	T.S	DEC/07/04	DC-DC VCC3M/VCC5M (MAX1631)		
THIS DOCUMENT IS THE PROPERTY OF IBM. ITS USE IS AUTHORIZED ONLY FOR RESPONDING TO A REQUEST FOR QUOTATION OR FOR THE PERFORMANCE OF WORK FOR IBM. ALL QUESTIONS MUST BE REFERRED TO THE IBM PURCHASING DEPARTMENT.					IBM CONFIDENTIAL

A B C D E F G H J K L M N P Q

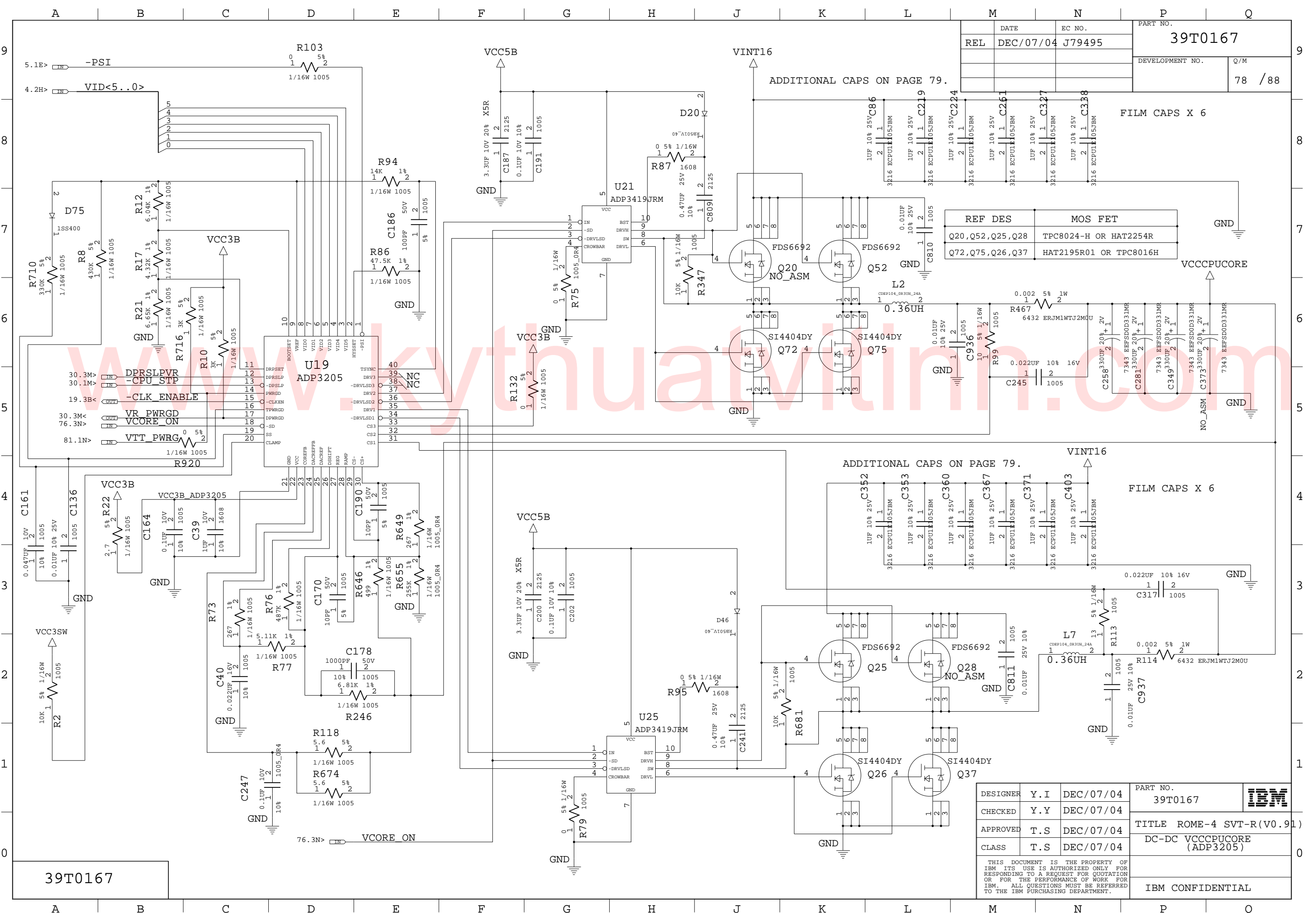

REL	DATE	EC NO.	PART NO.
	DEC/07/04	J79495	39T0167
DEVELOPMENT NO.			Q/M
			78 / 88

REF DES	MOS FET	
Q20, Q52, Q25, Q28	TPC8024-H OR HAT2254R	
Q72, Q75, Q26, Q37	HAT2195R01 OR TPC8016H	

DESIGNER	Y.I	DEC/07/04	PART NO.	39T0167	IBM
CHECKED	Y.Y	DEC/07/04			
APPROVED	T.S	DEC/07/04	TITLE ROME-4 SVT-R (V0.91)		
CLASS	T.S	DEC/07/04	DC-DC VCCCPUCORE (ADP3205)		
THIS DOCUMENT IS THE PROPERTY OF IBM. ITS USE IS AUTHORIZED ONLY FOR RESPONDING TO A REQUEST FOR QUOTATION OR FOR THE PERFORMANCE OF WORK FOR IBM. ALL QUESTIONS MUST BE REFERRED TO THE IBM PURCHASING DEPARTMENT.					IBM CONFIDENTIAL

39T0167

	DATE	EC NO.	PART NO.	
REL	DEC/07/04	J79495	39T0167	
			DEVELOPMENT NO.	Q/M
				79 /88

9
8
7
6
5
4
3
2
1
0

FOLLOWING 23 PCS OF 1.5UF ARE NO-ASM FOR VCCCPUCORE.

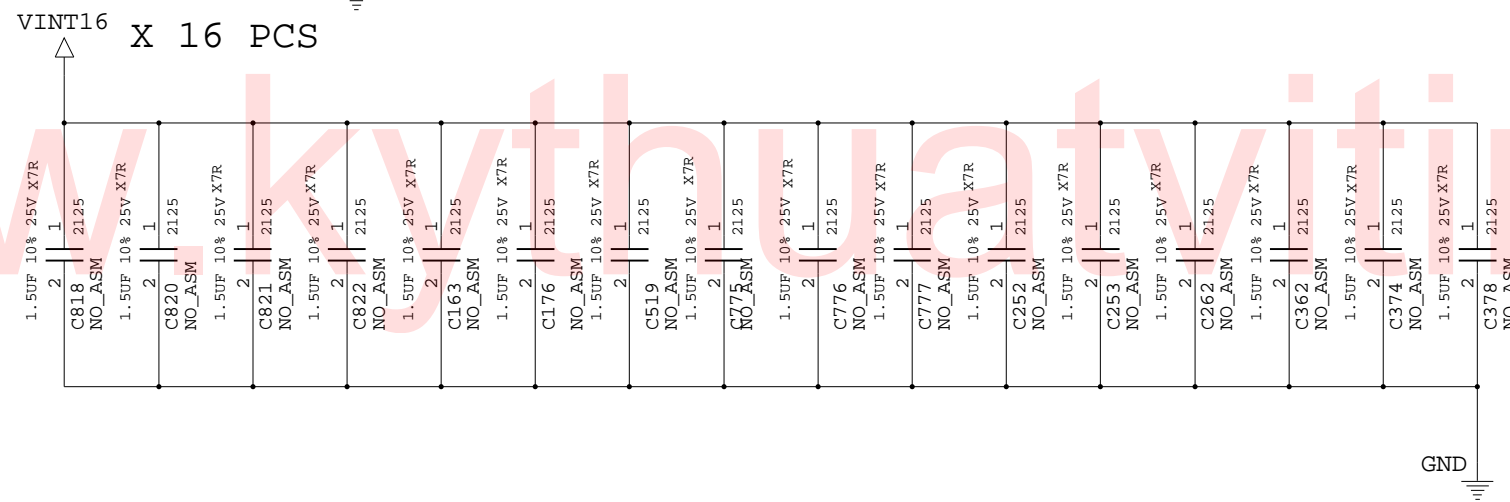
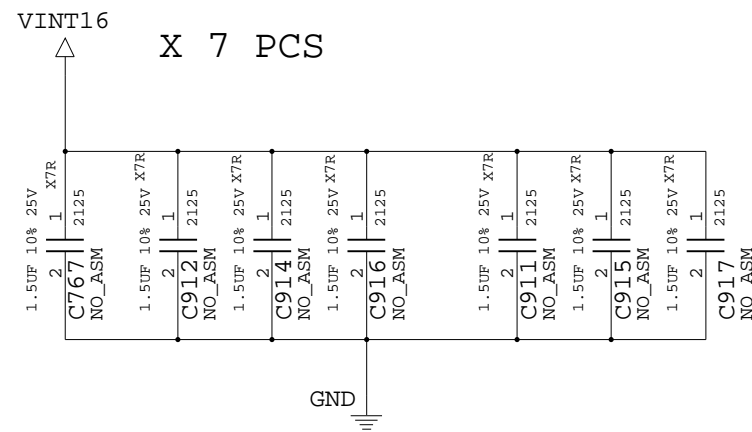

FOLLOWING 7 PCS OF 0.47UF AREA ASM FOR VCCCPUCORE TO REDUCE EMI.

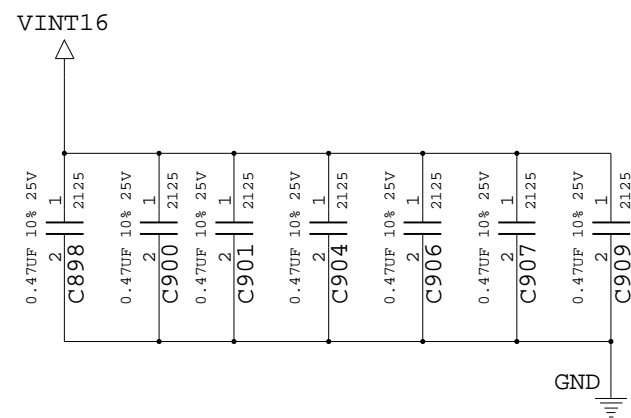

39T0167

DESIGNER	Y.I	DEC/07/04	PART NO.	39T0167	
CHECKED	Y.Y	DEC/07/04			
APPROVED	T.S	DEC/07/04	TITLE ROME-4 SVT-R(V0.91)		
CLASS	T.S	DEC/07/04	DC-DC VCORE INPUT CAP		
THIS DOCUMENT IS THE PROPERTY OF IBM ITS USE IS AUTHORIZED ONLY FOR RESPONDING TO A REQUEST FOR QUOTATION OR FOR THE PERFORMANCE OF WORK FOR IBM. ALL QUESTIONS MUST BE REFERRED TO THE IBM PURCHASING DEPARTMENT.				IBM CONFIDENTIAL	

DATE	DEC/07/04	EC NO.	J79495	PART NO.	39T0167
REL				DEVELOPMENT NO.	Q/M
					80 / 88

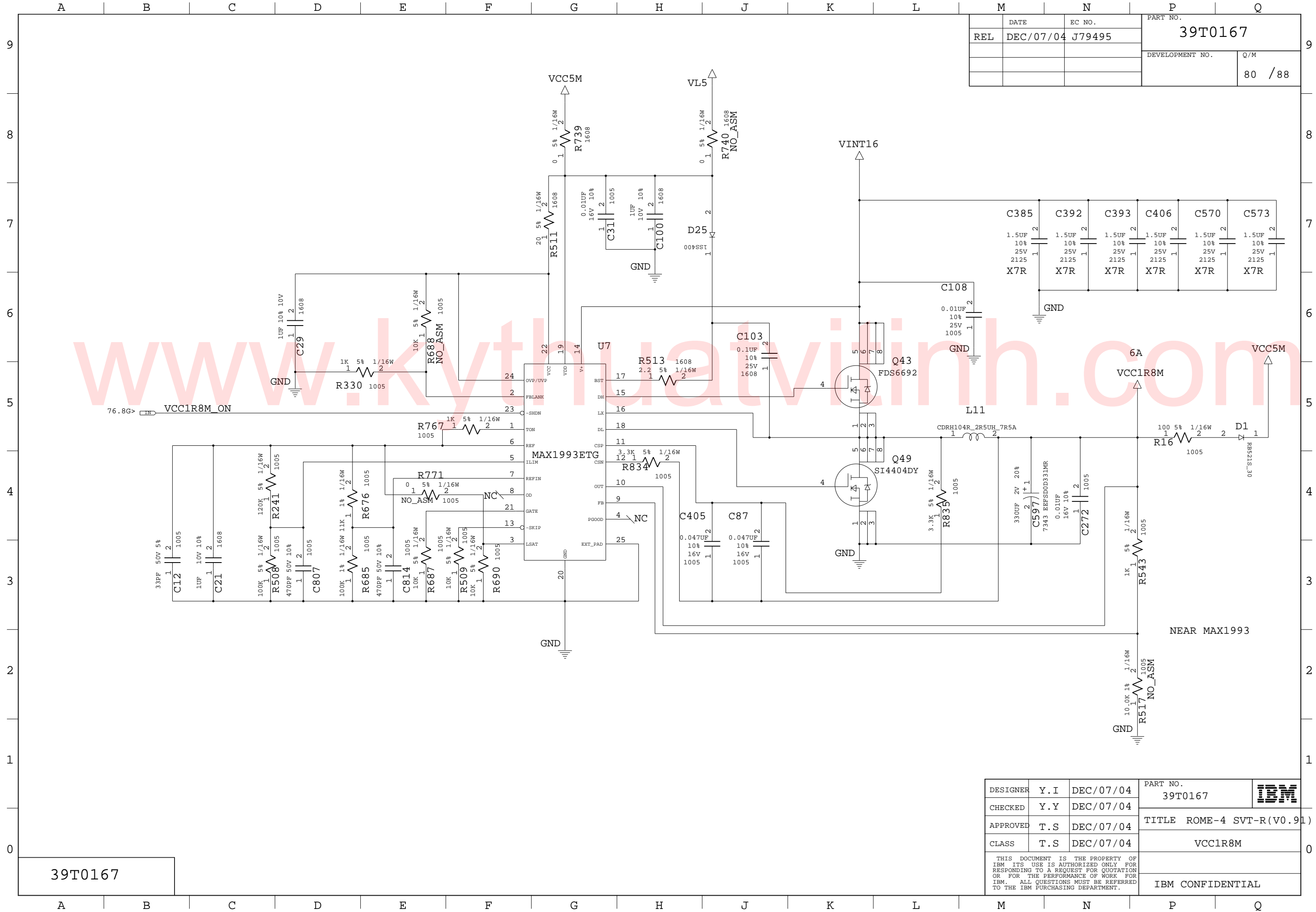

DESIGNER	Y.I	DEC/07/04	PART NO.	39T0167	
CHECKED	Y.Y	DEC/07/04	TITLE	ROME-4 SVT-R(V0.91)	
APPROVED	T.S	DEC/07/04	CLASS	VCC1R8M	
THIS DOCUMENT IS THE PROPERTY OF IBM ITS USE IS AUTHORIZED ONLY FOR RESPONDING TO A REQUEST FOR QUOTATION OR FOR THE PERFORMANCE OF WORK FOR IBM. ALL QUESTIONS MUST BE REFERRED TO THE IBM PURCHASING DEPARTMENT.				IBM CONFIDENTIAL	

39T0167

NEAR MAX1993

DATE	DEC/07/04	EC NO.	J79495	PART NO.	39T0167
REL				DEVELOPMENT NO.	Q/M
					81 / 88

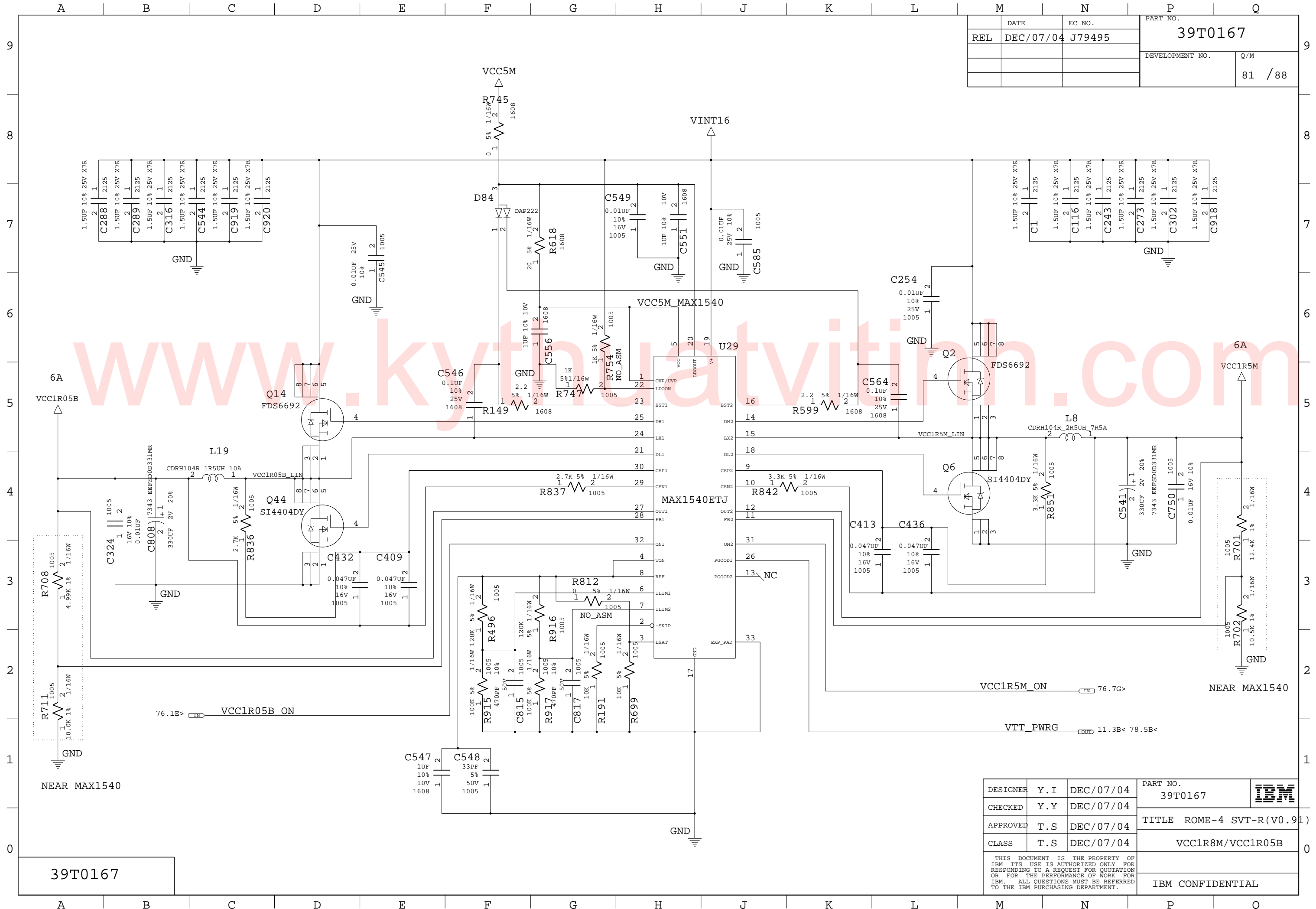

39T0167

DESIGNER	Y.I	DEC/07/04	PART NO.	39T0167	
CHECKED	Y.Y	DEC/07/04	TITLE	ROME-4 SVT-R(V0.91)	
APPROVED	T.S	DEC/07/04	CLASS	VCC1R8M/VCC1R05B	
THIS DOCUMENT IS THE PROPERTY OF IBM ITS USE IS AUTHORIZED ONLY FOR RESPONDING TO A REQUEST FOR QUOTATION OR FOR THE PERFORMANCE OF WORK FOR IBM. ALL QUESTIONS MUST BE REFERRED TO THE IBM PURCHASING DEPARTMENT.				IBM CONFIDENTIAL	

DATE	REL	EC NO.	PART NO.
DEC/07/04	DEC/07/04	J79495	39T0167
			DEVELOPMENT NO.
			Q/M
			82 / 88

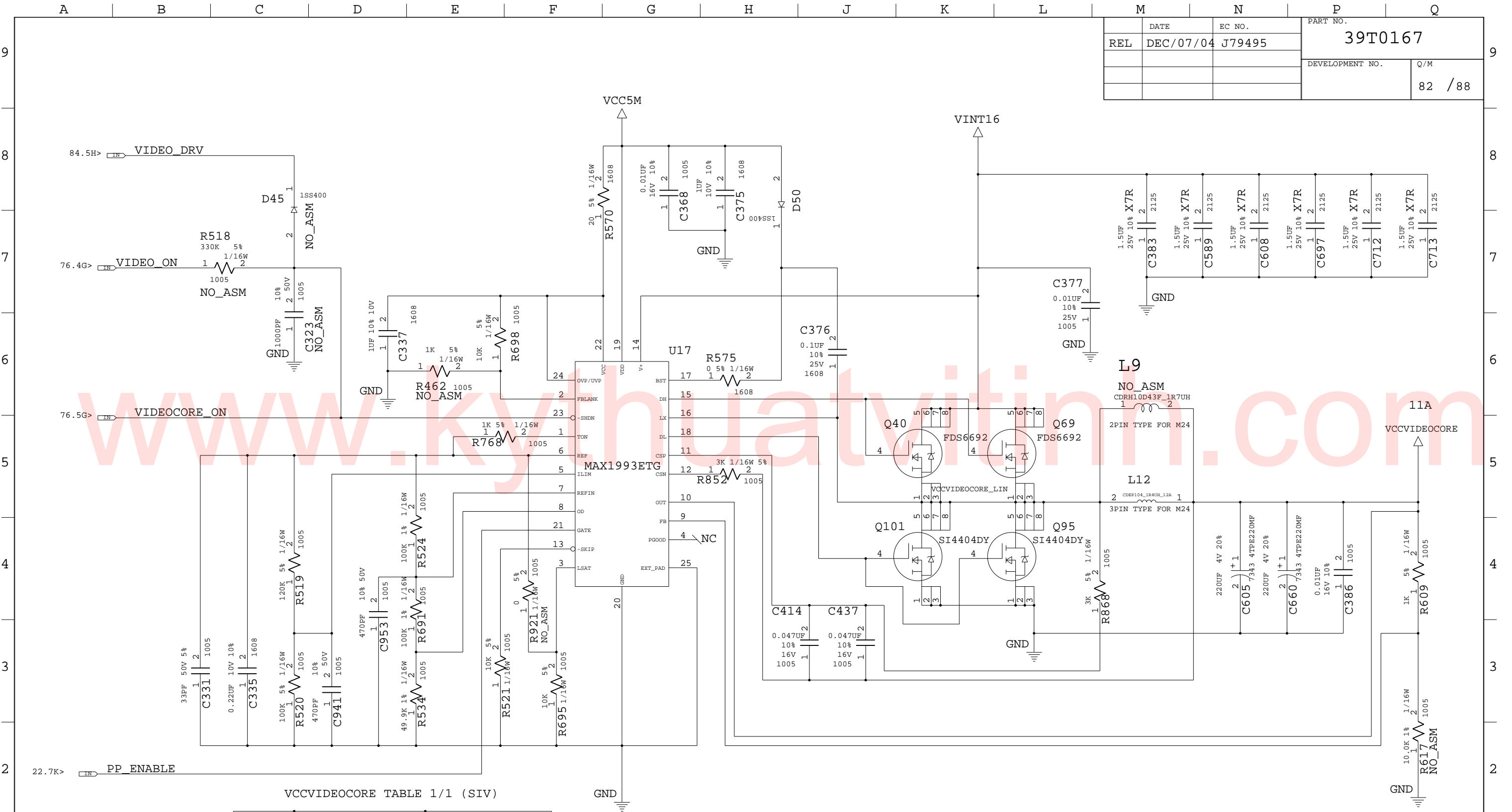

VCCVIDEOCORE TABLE 1/1 (SIV)

	M22 A12 (1.15V)	M24 A22 (1.2V)
R534	35.7K 1%	49.9K 1%

LOGIC

NEAR MAX1993

39T0167

DESIGNER	Y.I	DEC/07/04	PART NO.	39T0167	IBM
CHECKED	Y.Y	DEC/07/04			
APPROVED	T.S	DEC/07/04	TITLE ROME-4 SVT-R(V0.91)		
CLASS	T.S	DEC/07/04	VCCVIDEO		
THIS DOCUMENT IS THE PROPERTY OF IBM. ITS USE IS AUTHORIZED ONLY FOR RESPONDING TO A REQUEST FOR QUOTATION OR FOR THE PERFORMANCE OF WORK FOR IBM. ALL QUESTIONS MUST BE REFERRED TO THE IBM PURCHASING DEPARTMENT.				IBM CONFIDENTIAL	

	DATE	EC NO.	PART NO.
REL	DEC/07/04	J79495	39T0167
			DEVELOPMENT NO.
			Q/M
			83 / 88

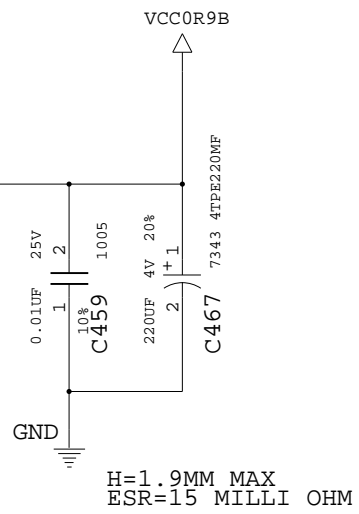
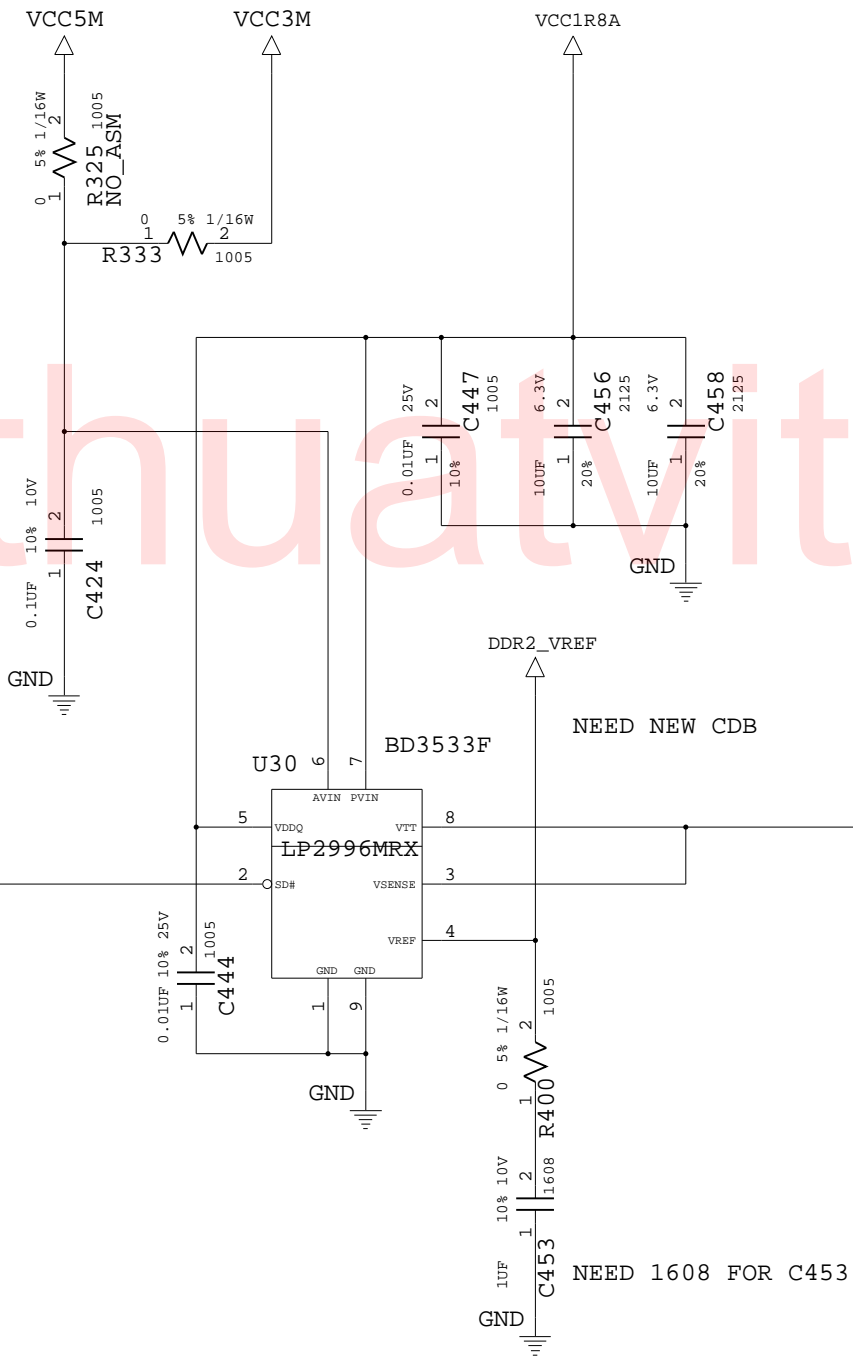
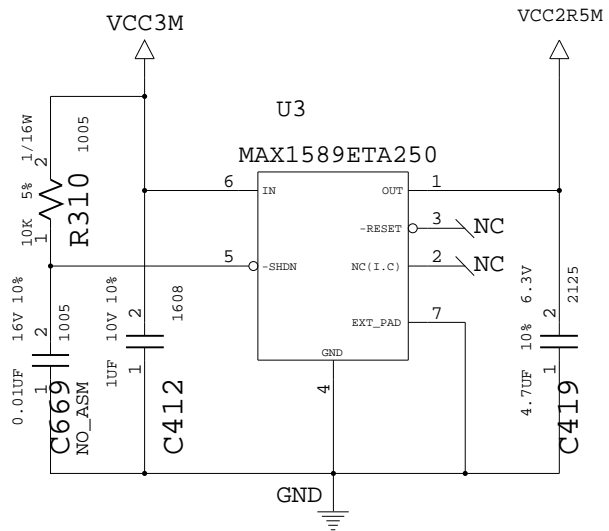

76.2G> VCC0R9B_ON

39T0167

DESIGNER	Y.I	DEC/07/04	PART NO.	IBM
CHECKED	Y.Y	DEC/07/04	39T0167	
APPROVED	T.S	DEC/07/04	TITLE ROME-4 SVT-R(V0.91)	
CLASS	T.S	DEC/07/04	VCC0R9B	
THIS DOCUMENT IS THE PROPERTY OF IBM ITS USE IS AUTHORIZED ONLY FOR RESPONDING TO A REQUEST FOR QUOTATION OR FOR THE PERFORMANCE OF WORK FOR IBM. ALL QUESTIONS MUST BE REFERRED TO THE IBM PURCHASING DEPARTMENT.				IBM CONFIDENTIAL

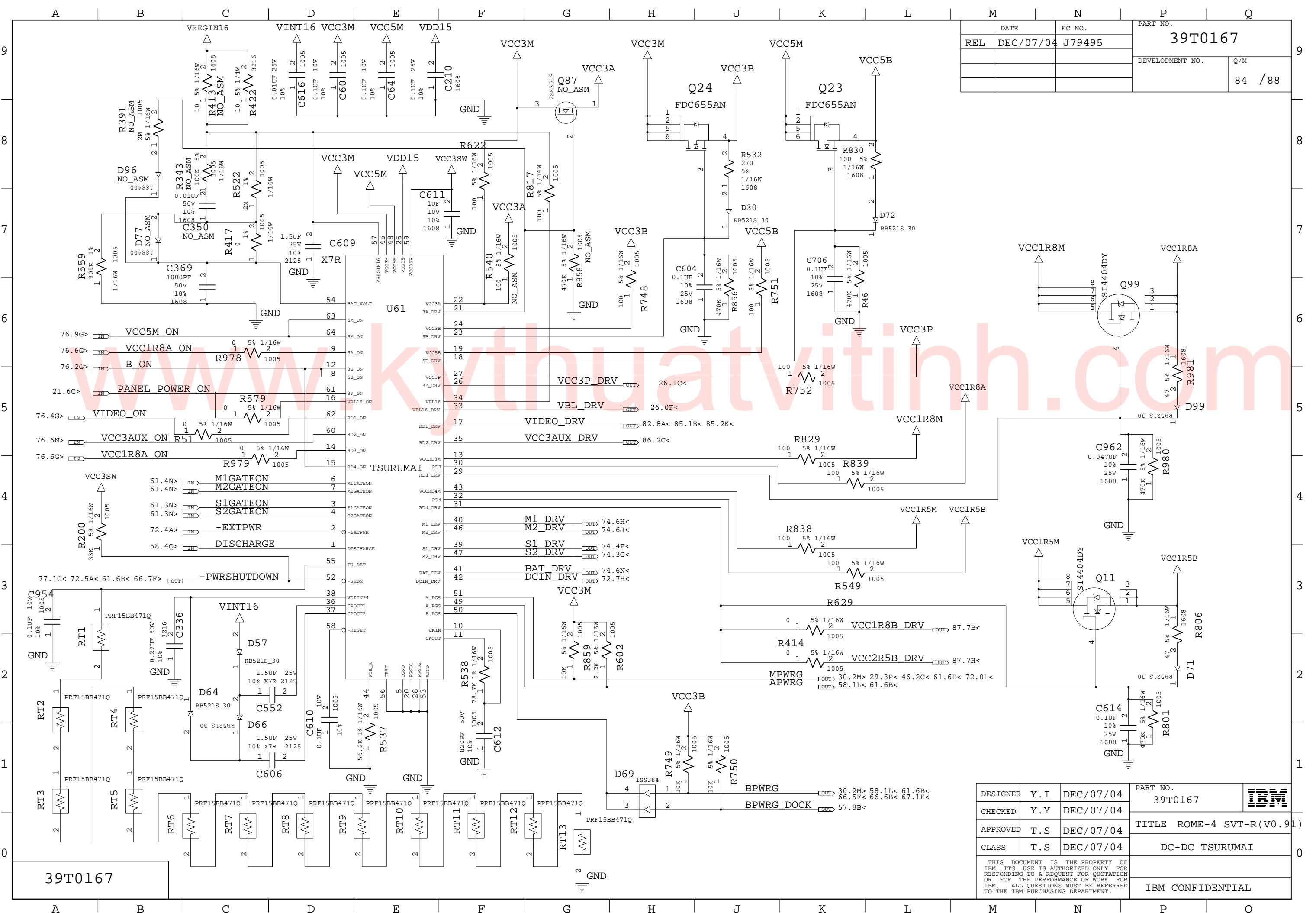

REL	DATE	EC NO.	PART NO.
	DEC/07/04	J79495	39T0167
			DEVELOPMENT NO.
			Q/M
			84 / 88

39T0167

DESIGNER	Y.I	DEC/07/04	PART NO.	39T0167	IBM
CHECKED	Y.Y	DEC/07/04			
APPROVED	T.S	DEC/07/04	TITLE ROME-4 SVT-R (V0.91)		
CLASS	T.S	DEC/07/04	DC-DC TSURUMAI		
THIS DOCUMENT IS THE PROPERTY OF IBM. ITS USE IS AUTHORIZED ONLY FOR RESPONDING TO A REQUEST FOR QUOTATION OR FOR THE PERFORMANCE OF WORK FOR IBM. ALL QUESTIONS MUST BE REFERRED TO THE IBM PURCHASING DEPARTMENT.				IBM CONFIDENTIAL	

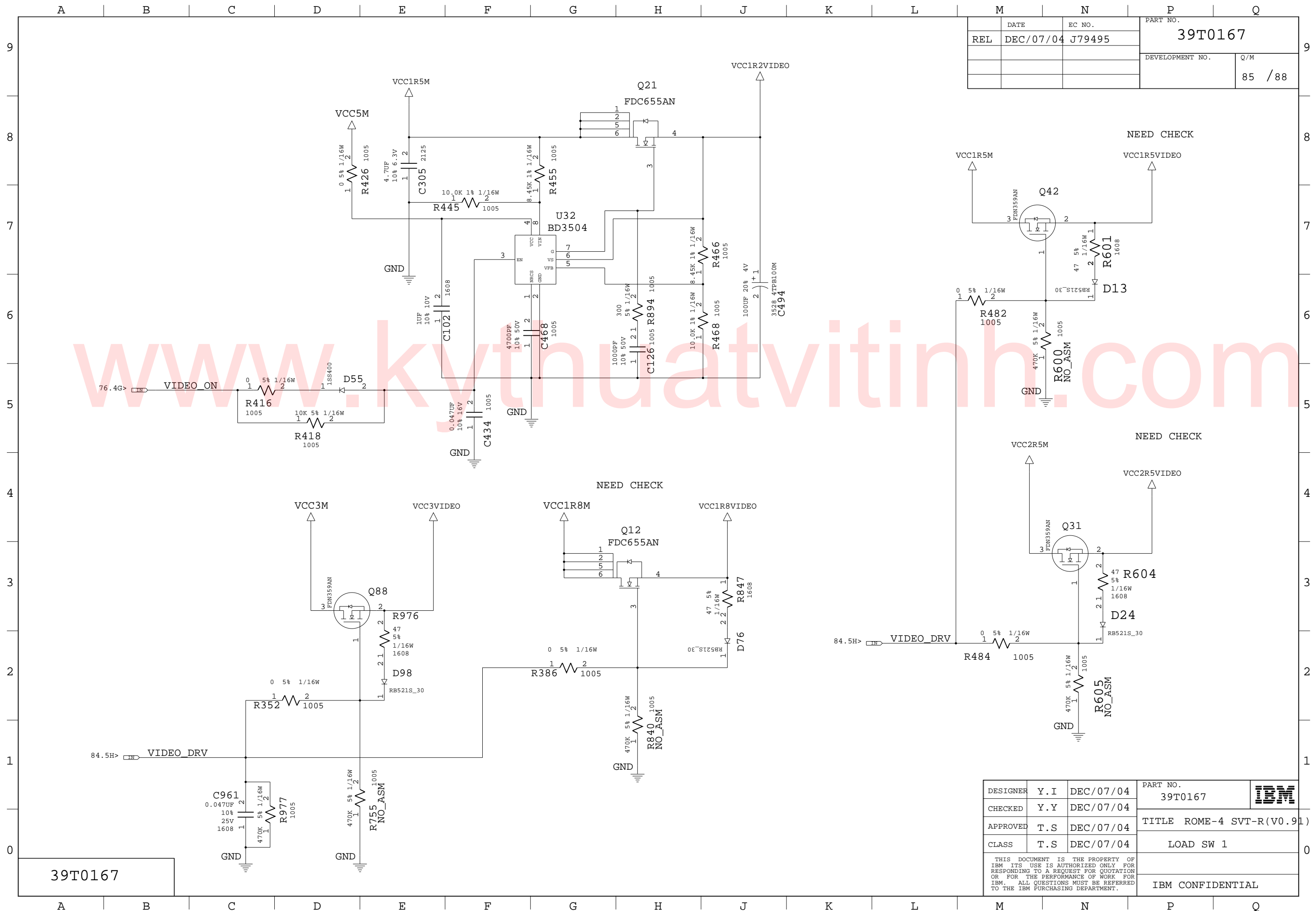

DATE	EC NO.	PART NO.	
REL DEC/07/04	J79495	39T0167	
		DEVELOPMENT NO.	Q/M
			85 / 88

39T0167

DESIGNER	Y.I	DEC/07/04	PART NO.	39T0167	IBM
CHECKED	Y.Y	DEC/07/04			
APPROVED	T.S	DEC/07/04	TITLE ROME-4 SVT-R(V0.91)		
CLASS	T.S	DEC/07/04	LOAD SW 1		
THIS DOCUMENT IS THE PROPERTY OF IBM. ITS USE IS AUTHORIZED ONLY FOR RESPONDING TO A REQUEST FOR QUOTATION OR FOR THE PERFORMANCE OF WORK FOR IBM. ALL QUESTIONS MUST BE REFERRED TO THE IBM PURCHASING DEPARTMENT.				IBM CONFIDENTIAL	

	DATE	EC NO.	PART NO.
REL	DEC/07/04	J79495	39T0167
			DEVELOPMENT NO.
			Q/M
			86 / 88

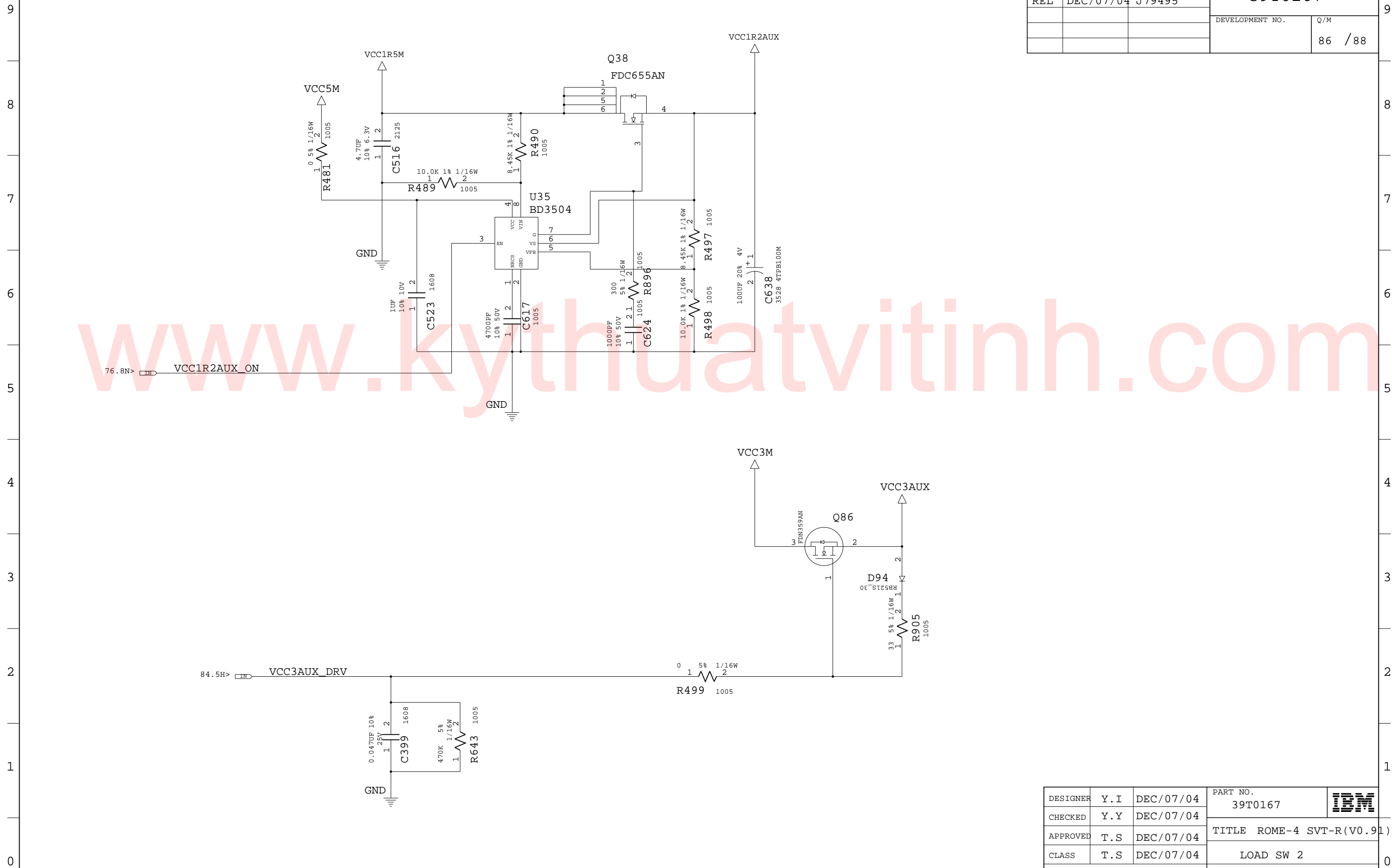

39T0167

DESIGNER	Y. I	DEC/07/04	PART NO.	39T0167	IBM
CHECKED	Y. Y	DEC/07/04			
APPROVED	T. S	DEC/07/04	TITLE ROME-4 SVT-R (V0.91)		
CLASS	T. S	DEC/07/04	LOAD SW 2		
THIS DOCUMENT IS THE PROPERTY OF IBM. ITS USE IS AUTHORIZED ONLY FOR RESPONDING TO A REQUEST FOR QUOTATION OR FOR THE PERFORMANCE OF WORK FOR IBM. ALL QUESTIONS MUST BE REFERRED TO THE IBM PURCHASING DEPARTMENT.				IBM CONFIDENTIAL	

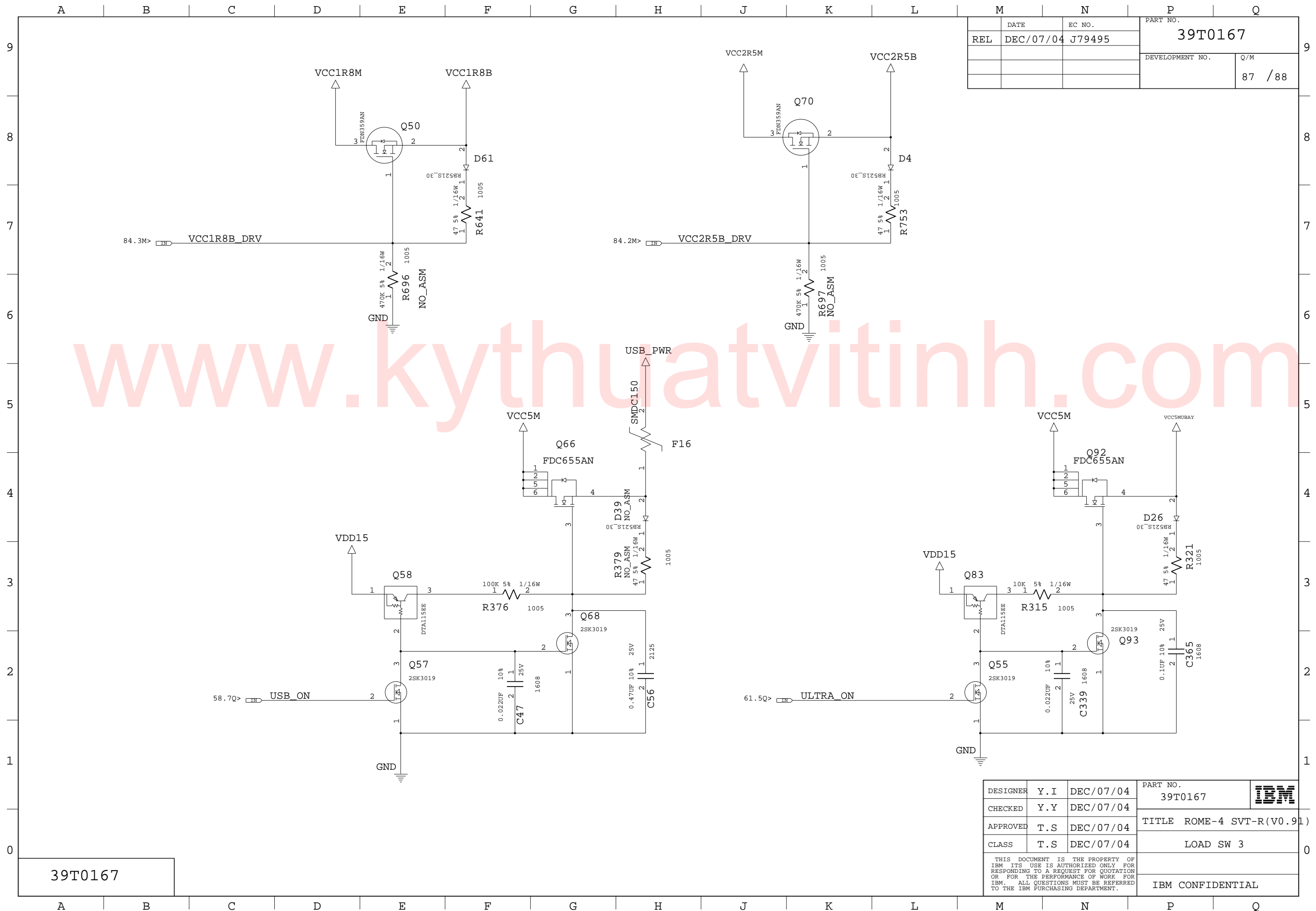

DATE	EC NO.	PART NO.
REL DEC/07/04	J79495	39T0167
		DEVELOPMENT NO.
		Q/M
		87 / 88

39T0167

DESIGNER	Y.I	DEC/07/04	PART NO.	39T0167	IBM
CHECKED	Y.Y	DEC/07/04			
APPROVED	T.S	DEC/07/04	TITLE ROME-4 SVT-R(V0.91)		
CLASS	T.S	DEC/07/04	LOAD SW 3		
THIS DOCUMENT IS THE PROPERTY OF IBM. ITS USE IS AUTHORIZED ONLY FOR RESPONDING TO A REQUEST FOR QUOTATION OR FOR THE PERFORMANCE OF WORK FOR IBM. ALL QUESTIONS MUST BE REFERRED TO THE IBM PURCHASING DEPARTMENT.				IBM CONFIDENTIAL	

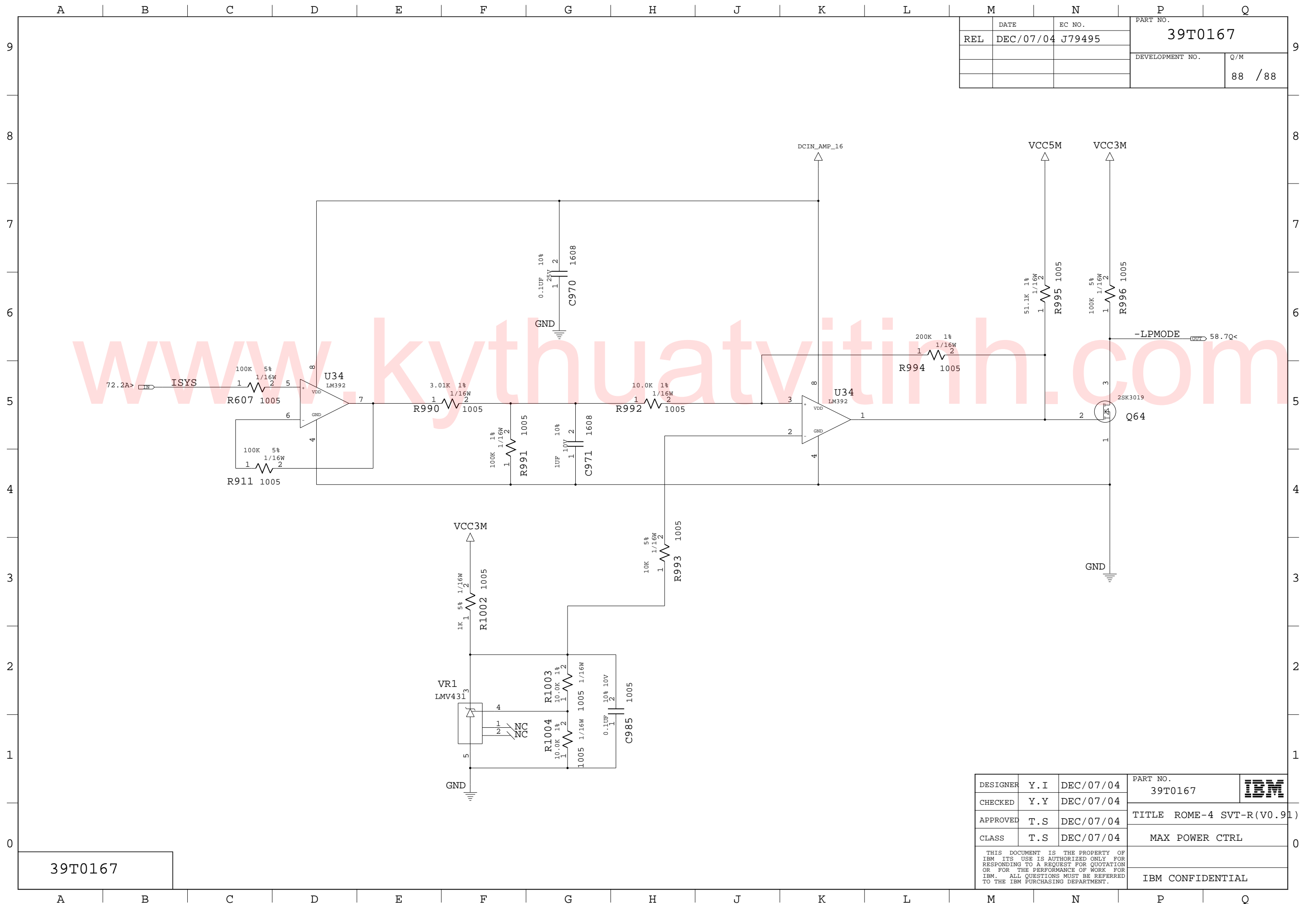

REL	DATE DEC/07/04	EC NO. J79495	PART NO. 39T0167
			DEVELOPMENT NO. 88 / 88
			Q/M

39T0167

DESIGNER	Y. I	DEC/07/04	PART NO. 39T0167	IBM
CHECKED	Y. Y	DEC/07/04		
APPROVED	T. S	DEC/07/04	TITLE ROME-4 SVT-R (V0.91)	
CLASS	T. S	DEC/07/04	MAX POWER CTRL	
THIS DOCUMENT IS THE PROPERTY OF IBM. ITS USE IS AUTHORIZED ONLY FOR RESPONDING TO A REQUEST FOR QUOTATION OR FOR THE PERFORMANCE OF WORK FOR IBM. ALL QUESTIONS MUST BE REFERRED TO THE IBM PURCHASING DEPARTMENT.				IBM CONFIDENTIAL