

# LISA-7 FOR SVT

(DAVINCI-1 INTEG GFX)

DATE	EC NO.	PART NO.
12/01/05	G33460	41W0930
		DEVELOPMENT NO.
		Q/M
		1 /92

## VER 5.04

DEC/01/2005

- |  |  |
|--|--|
| <ol style="list-style-type: none"> <li>1. TITLE PAGE</li> <li>2. EC HISTORY</li> <li>3. CPU(1/3)</li> <li>4. CPU(2/3)</li> <li>5. CPU(3/3)</li> <li>6. ITP CON/LARGE PTH HOLE/EMI FINGER</li> <li>7. VCCCPUCORE DECOUPLING</li> <li>8. CALISTOGA(1/7) : HOST I/F</li> <li>9. CALISTOGA(2/7) : DDR2-A</li> <li>10. CALISTOGA(3/7) : DDR2-B</li> <li>11. CALISTOGA(4/7) : PEG/DMI</li> <li>12. CALISTOGA(5/7) : GRAPHICS</li> <li>13. CALISTOGA(6/7) : VCC</li> <li>14. CALISTOGA(7/7) : GND</li> <li>15. DDR2 SODIMM-A</li> <li>16. DDR2 SODIMM-B</li> <li>17. DDR2 TERMINATION</li> <li>18. DDR2 DECOUPLING</li> <li>19. CLOCK GEN(ICS954309)</li> <li>20. DVI TRANSMITTER</li> <li>21. BLANK</li> <li>22. BLANK</li> <li>23. BLANK</li> <li>24. BLANK</li> <li>25. BLANK</li> <li>26. LCD CONNECTOR</li> <li>27. EXT CRT INTERFACE</li> <li>28. PATA I/F PU</li> <li>29. ICH7-M(1/4) : DMI/PCI/LPC/AC97</li> <li>30. ICH7-M(2/4) : ATA/USB/PM</li> <li>31. ICH7-M(3/4) : PCI EXPRESS</li> <li>32. ICH7-M(4/4) : VCC/GND</li> <li>33. FWH,RTC BATTERY</li> <li>34. SATA HDD CONN</li> <li>35. BAY I/F CONN</li> <li>36. USB POWER/CONN</li> <li>37. AUDIO AD1981HD</li> <li>38. AUDIO MISC</li> <li>39. AUDIO INT MIC</li> <li>40. AUDIO HP &amp; EXT MIC CONN</li> <li>41. AUDIO EXT MIC AMP</li> <li>42. AUDIO SPEAKER</li> <li>43. AUDIO HDP AMP MAX9750</li> <li>44. AUDIO HDP AMP MISC</li> </ol> | <ol style="list-style-type: none"> <li>45. CDC CONNECTOR</li> <li>46. CARDBUS CONTROLLER(1/2)</li> <li>47. CARDBUS CONTROLLER(2/2)</li> <li>48. CARDBUS/EXC SLOT</li> <li>49. CARDBUS/EXC PWR CTRL</li> <li>50. GBE LAN SW</li> <li>51. GBE VIDALIA(1/2)</li> <li>52. GBE VIDALIA(2/2)</li> <li>53. GBE MAGNETICS</li> <li>54. RJ11/RJ45 CONNECTOR</li> <li>55. MINI-PCIE SLOT</li> <li>56. EEPROM/FLASH/SHARED</li> <li>57. DOCKING CONNECTOR</li> <li>58. H8S/2116(1/2)</li> <li>59. H8S/2116(2/2)</li> <li>60. KEYBOARD CONNECTOR</li> <li>61. TOUCH PAD CONNECTOR</li> <li>62. MISC G/A (PMH7)</li> <li>63. SUPER I/O (PC87382)</li> <li>64. WIRELESS DISABLE SW</li> <li>65. LEGACY IO INTERFACE</li> <li>66. IR MODULE</li> <li>67. THERMAL SENSOR</li> <li>68. I2CBUS/SMBUS</li> <li>69. FAN CONTROL</li> <li>70. G-SENSOR</li> <li>71. EMC DECOUPLING</li> <li>72. RGB SWITCH</li> <li>73. DC-IN</li> <li>74. BATTERY CHARGER (MAX8632)</li> <li>75. CHARGE SELECTOR</li> <li>76. BATTERY INPUT</li> <li>77. BATTERY MONITOR</li> <li>78. POWER SEQUENCE</li> <li>79. DC-DC VCC3M/VCC5M (MAX1901ETJ)</li> <li>80. DC-DC VCCCPUCORE (ADP3207)</li> <li>81. DC-DC VCORE INPUT CAP</li> <li>82. DC-DC VCC1R8A/VCC0R9B (MAX8632)</li> <li>83. DC-DC VCC1R5M/VCC1R05B (MAX1540ETJ)</li> <li>84. BLANK</li> <li>85. DC-DC VCC2R5M (BD3508EKN)</li> <li>86. TSURUMAI-2</li> <li>87. BLANK</li> <li>88. LOAD SW 2 (AUX)</li> <li>89. LOAD SW 3 (B,UBAY)</li> <li>90. MAX POWER CTRL</li> <li>91. POWER MOMITOR</li> <li>92. PTH FOR SCREW HOLES</li> </ol> |
|--|--|

41W0930

DESIGNER	Y.Y	12/01/05	PART NO.	41W0930	
CHECKED	Y.I	12/01/05	TITLE LISA-7(VER 5.04)		
APPROVED	T.S	12/01/05	TITLE PAGE		
CLASS			THIS DOCUMENT IS THE PROPERTY OF IBM. ITS USE IS AUTHORIZED ONLY FOR RESPONDING TO A REQUEST FOR QUOTATION OR FOR THE PERFORMANCE OF WORK FOR IBM. ALL QUESTIONS MUST BE REFERRED TO THE IBM PURCHASING DEPARTMENT.		
			LENOVO CONFIDENTIAL		

# EC HISTORY

DATE	EC NO.	PART NO.
12/01/05	G33460	41W0930
		DEVELOPMENT NO.
		Q/M
		2 /92

## SDV

VER.0.00 03/16/2005 APPLY INITIAL EC - DAV\_I\_SDV\_EC002  
 VER.0.01 03/22/2005 APPLY EC244,245  
 VER.0.02 03/23/2005 APPLY EC247-249,251,252,254,255  
 VER.0.03 03/25/2005 APPLY EC256,232,238,239,257,259,260,262  
 VER.0.04 03/25/2005 APPLY EC263,265,266  
 VER.0.05 03/31/2005 APPLY EC270  
 VER.0.06 03/31/2005 APPLY EC267,269,271  
 VER.0.07 04/05/2005 ERROR CORRECTION:PAGE-12 C7,C10

## PHASE-3

VER.1.00 05/16/2005 APPLY EC001,002,007-024,026,028-030,035  
 VER.1.01 05/17/2005 APPLY EC047,048  
 VER.1.02 05/18/2005 APPLY EC046  
 VER.1.03 05/19/2005 APPLY EC037,038,039,040,041,042,043,046(I2C)  
 EC049,050,051,052  
 VER.1.04 05/20/2005 APPLY EC054,055,056,057,059,060  
 VER.1.05 05/24/2005 APPLY EC062,063,065,066,067  
 VER.1.06 05/26/2005 CHANGE USB CONN.(J10),APPLY EC069,070,075  
 VER.1.07 06/01/2005 APPLY EC071,073,076,079,EC080  
 VER.1.08 06/01/2005 APPLY EC081  
 VER.1.09 06/03/2005 APPLY EC082,EC084  
 VER.1.10 06/10/2005 APPLY EC087,089,093,094,095  
 VER.1.11 06/16/2005 APPLY EC096,097,098,099,100,101,102

## PHASE-4

VER.2.00 06/29/2005 RENUMBER FET ID REQUESTED BY KOZASU-SAN  
 APPLY EC002,003,004,006,011,012,014,015,016,  
 018,019,020,021,022,024,025,028,029  
 VER.2.01 07/08/2005 APPLY 030,032,034,035,039,041,042  
 VER.2.02 07/14/2005 APPLY 044,045,046,047,048,049,050,051,056,057,  
 060,061,062,063,064,065,066,067,068,069  
 VER.2.03 07/19/2005 APPLY 070,071,073,078  
 VER.2.04 07/20/2005 APPLY 023,072,081,082  
 VER.2.05 07/21/2005 CORRECT CHIP-R VALUE/ADD CAP FOR EC045  
 VER.2.06 07/27/2005 APPLY 086,087,088,089,093,094,095,096,097,098,100  
 CHANGE WIRELESS SW TO SMK  
 VER.2.07 07/28/2005 APPLY 017,036,101  
 VER.2.08 07/29/2005 APPLY 104,EC100 CORRECTION  
 VER.2.09 08/01/2005 APPLY 103,105,106  
 VER.2.10 08/02/2005 APPLY 109,110,111

VER.2.11 08/04/2005 APPLY 112,113  
 VER.2.12 08/05/2005 APPLY 117  
 VER.2.13 08/12/2005 APPLY 119,122  
 VER.2.14 08/22/2005 APPLY 123

## SIT

VER.3.00 08/24/2005 APPLY SIT 001,002,005,006,007,008,010,011  
 VER.3.01 08/29/2005 APPLY 013,016,017,019,021,022  
 VER.3.02 08/30/2005 APPLY 027,028,030,031,032,034,035,036,037,038,039,040  
 VER.3.03 09/01/2005 APPLY 044,045,046,048  
 VER.3.04 09/02/2005 APPLY 049,050,051,052  
 VER.3.05 09/05/2005 APPLY 054  
 VER.3.06 09/08/2005 APPLY 060,061  
 VER.3.07 09/13/2005 APPLY 062,CHG TO LP CLK GEN,063,064  
 VER.3.08 09/21/2005 RN26,27,28 CHG TO 33-OHM 5% ,APPLY EC 068,069  
 VER.3.09 09/22/2005 APPLY 070,071  
 (EC 073 DISABLE THERMAL SENSOR IS NOT APPLIED TO LOGIC.  
 IT'S APPLIED TO BOM/CPL ONLY.)

## SIT-R

VER.4.00 10/17/2005 APPLY SIT-R 001,003,004,005,008,009  
 VER.4.01 10/20/2005 APPLY 012,013,014,017,019,020,021,022,023,024,025,026,028  
 VER.4.02 10/21/2005 APPLY 030,035  
 VER.4.03 10/24/2005 APPLY 037,038,039,041,043  
 VER.4.04 10/25/2005 APPLY 044,047,049  
 VER.4.05 10/26/2005 APPLY 048,050,057  
 VER.4.06 10/27/2005 APPLY 059,060  
 VER.4.07 11/02/2005 APPLY 062,064

## SVT

VER.5.00 11/08/2005 CHANGE HOLE SIZE,APPLY 002  
 VER.5.01 11/14/2005 APPLY 005,012,016  
 VER.5.02 11/16/2005 APPLY 019  
 VER.5.03 11/21/2005 APPLY 021,022  
 VER.5.04 12/01/2005 APPLY 023,024,027

41W0930

DESIGNER	Y.Y	12/01/05	PART NO.	41W0930	
CHECKED	Y.I	12/01/05			
APPROVED	T.S	12/01/05	TITLE LISA-7(VER 5.04)		
CLASS			HISTORY		
THIS DOCUMENT IS THE PROPERTY OF IBM ITS USE IS AUTHORIZED ONLY FOR RESPONDING TO A REQUEST FOR QUOTATION OR FOR THE PERFORMANCE OF WORK FOR IBM. ALL QUESTIONS MUST BE REFERRED TO THE IBM PURCHASING DEPARTMENT.				LENOVO CONFIDENTIAL	

DATE	EC NO.	PART NO.	
12/01/05	G33460	41W0930	
DEVELOPMENT NO.		Q/M	
3		/92	

U58

YONAH(1/3)

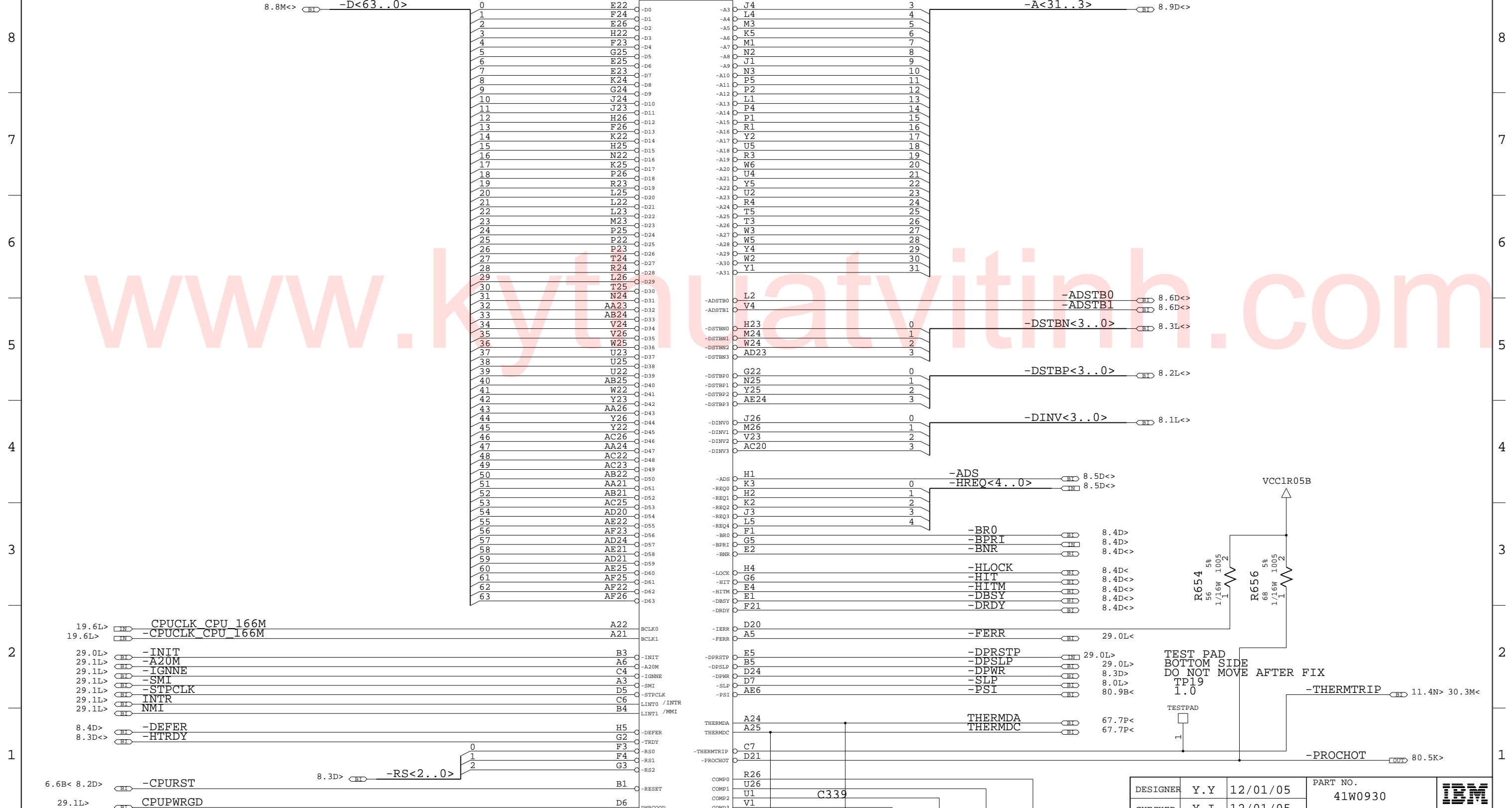

PLACE NEAR CPU

COMP0/2: Z0=27.4 OHM TRACE <0.5"  
 COMP1/3: Z0=55 OHM TRACE <0.5"

DESIGNER	Y.Y	12/01/05	PART NO.	41W0930	IBM
CHECKED	Y.I	12/01/05	TITLE LISA-7(VER 5.04)		
APPROVED	T.S	12/01/05	CLASS CPU(1/3)		
THIS DOCUMENT IS THE PROPERTY OF IBM ITS USE IS AUTHORIZED ONLY FOR RESPONDING TO A REQUEST FOR QUOTATION OR FOR THE PERFORMANCE OF WORK FOR IBM. ALL QUESTIONS MUST BE REFERRED TO THE IBM PURCHASING DEPARTMENT.					LENOVO CONFIDENTIAL

41W0930

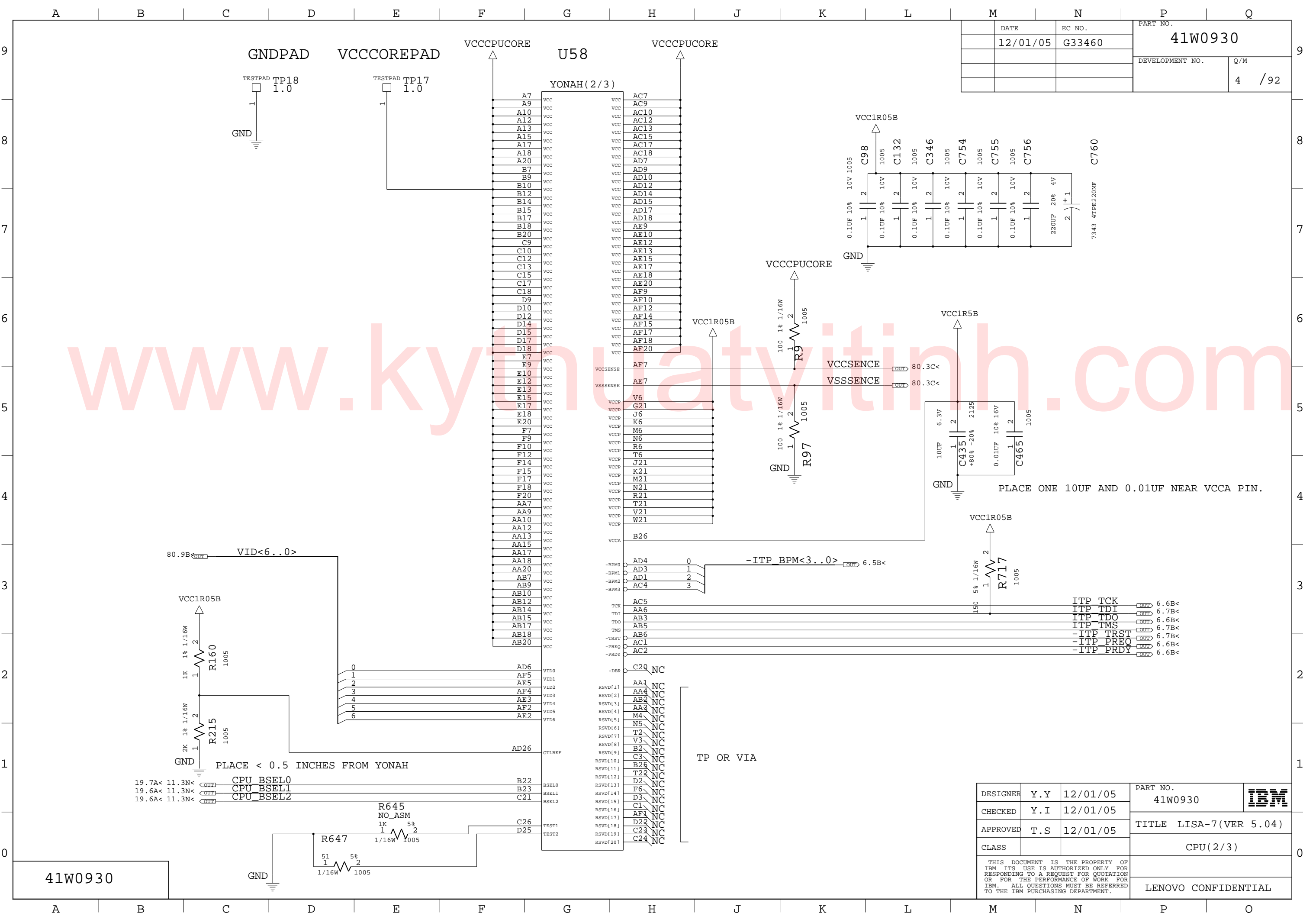

DATE	EC NO.	PART NO.	
12/01/05	G33460	41W0930	
DEVELOPMENT NO.		Q/M	
		4 / 92	

DESIGNER	Y.Y	12/01/05	PART NO.	41W0930	IBM
CHECKED	Y.I	12/01/05	TITLE		
APPROVED	T.S	12/01/05	CPU(2/3)		
CLASS				LENVO CONFIDENTIAL	

THIS DOCUMENT IS THE PROPERTY OF IBM. ITS USE IS AUTHORIZED ONLY FOR RESPONDING TO A REQUEST FOR QUOTATION OR FOR THE PERFORMANCE OF WORK FOR IBM. ALL QUESTIONS MUST BE REFERRED TO THE IBM PURCHASING DEPARTMENT.

41W0930

19.7A < 11.3N <  
 19.6A < 11.3N <  
 19.6A < 11.3N <

PLACE < 0.5 INCHES FROM YONAH

PLACE ONE 10UF AND 0.01UF NEAR VCCA PIN.

TP OR VIA

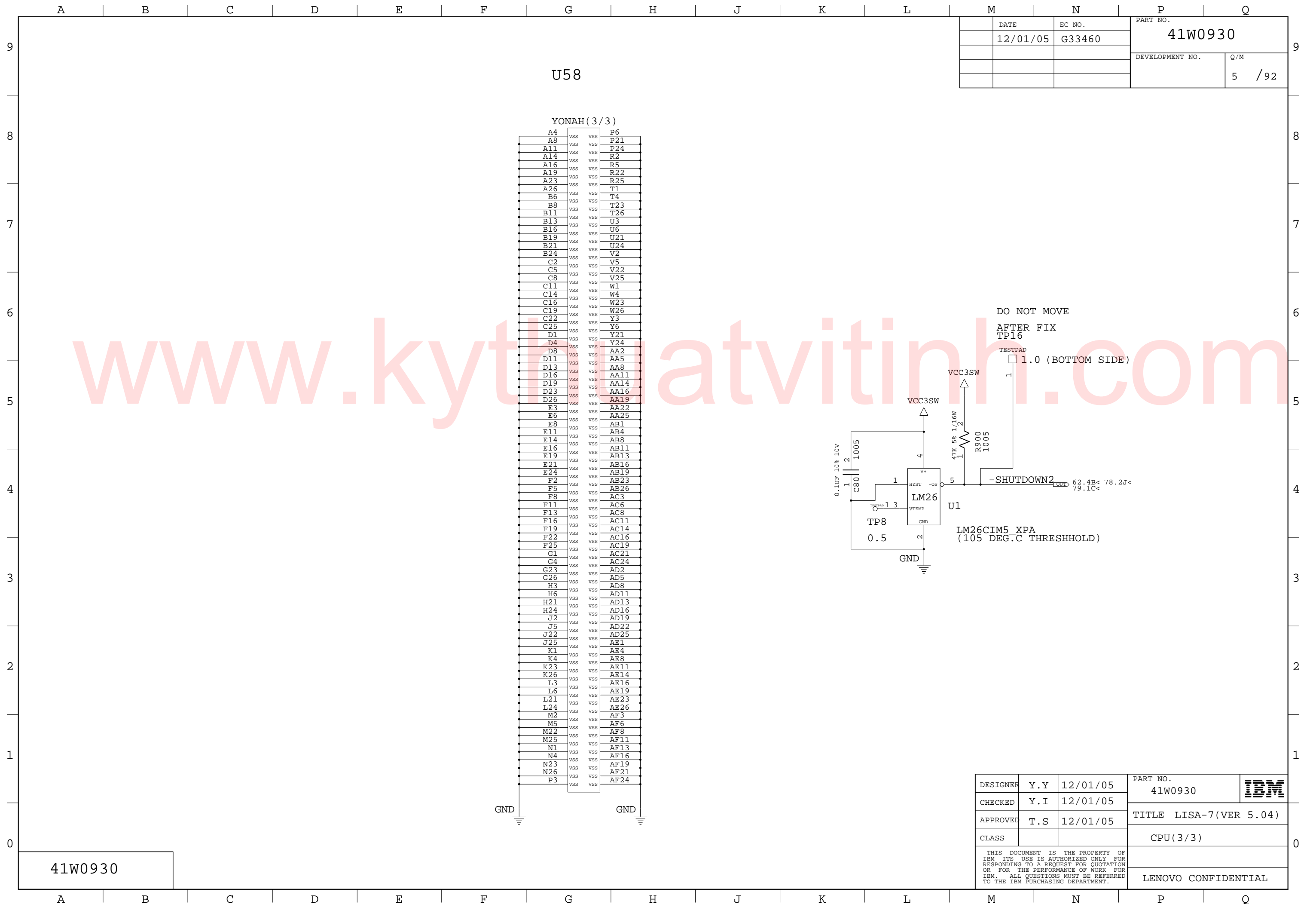

DATE	12/01/05	EC NO.	G33460	PART NO.	41W0930		
				DEVELOPMENT NO.	5	Q/M	/92

41W0930

DESIGNER	Y.Y	12/01/05	PART NO.	41W0930	<b>IBM</b>
CHECKED	Y.I	12/01/05	TITLE LISA-7(VER 5.04)		
APPROVED	T.S	12/01/05	CPU(3/3)		
CLASS					
THIS DOCUMENT IS THE PROPERTY OF IBM ITS USE IS AUTHORIZED ONLY FOR RESPONDING TO A REQUEST FOR QUOTATION OR FOR THE PERFORMANCE OF WORK FOR IBM. ALL QUESTIONS MUST BE REFERRED TO THE IBM PURCHASING DEPARTMENT.					LENOVO CONFIDENTIAL



DATE	12/01/05	EC NO.	G33460	PART NO.	41W0930
				DEVELOPMENT NO.	6 / 92

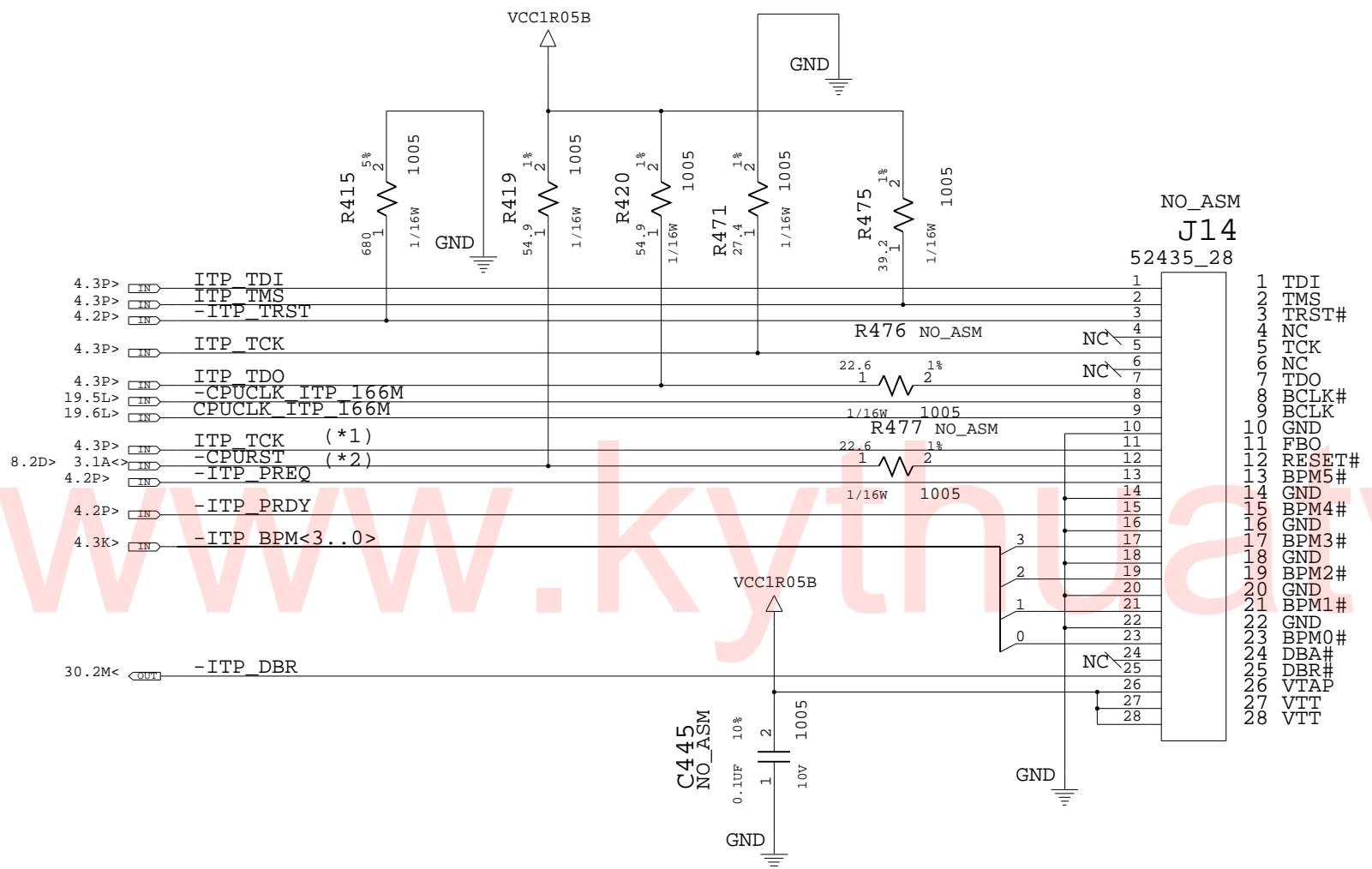

(\*1) TCK SIGNAL IS BRANCHED AT YONAH PIN  
 (\*2) -CPURST SIGNAL IS BRANCHED AT CALISTOGA PIN

41W0930

DESIGNER	Y.Y	12/01/05	PART NO.	41W0930	<b>IBM</b>
CHECKED	Y.I	12/01/05	TITLE LISA-7(VER 5.04)		
APPROVED	T.S	12/01/05	ITP CONN/LARGE PTH HOLE		
CLASS			EMI FINGER		
THIS DOCUMENT IS THE PROPERTY OF IBM ITS USE IS AUTHORIZED ONLY FOR RESPONDING TO A REQUEST FOR QUOTATION OR FOR THE PERFORMANCE OF WORK FOR IBM. ALL QUESTIONS MUST BE REFERRED TO THE IBM PURCHASING DEPARTMENT.					LENOVO CONFIDENTIAL

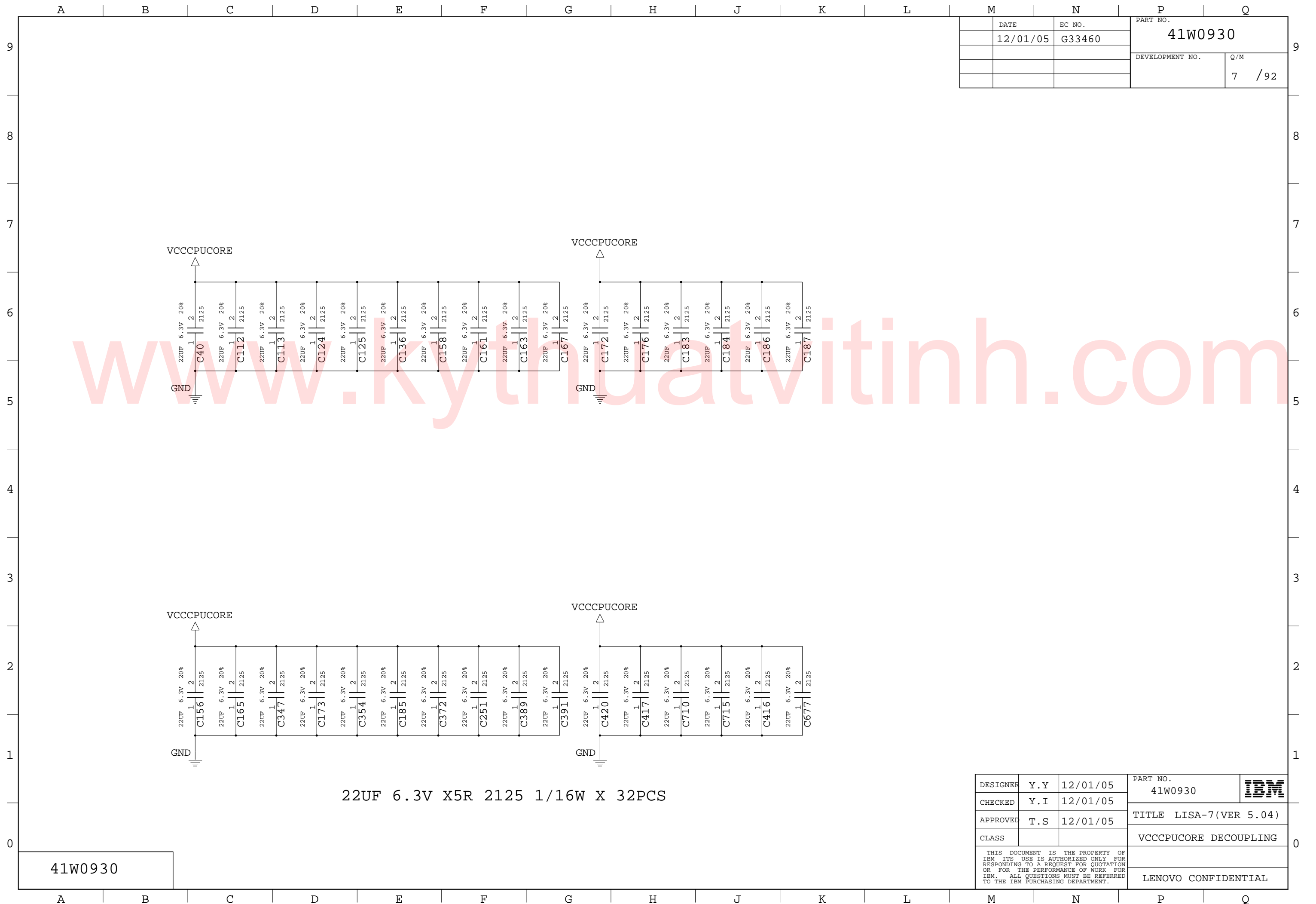

DATE	EC NO.	PART NO.	
12/01/05	G33460	41W0930	
		DEVELOPMENT NO.	Q/M
			7 / 92

41W0930

DESIGNER	Y.Y	12/01/05	PART NO.	41W0930	
CHECKED	Y.I	12/01/05			
APPROVED	T.S	12/01/05	TITLE LISA-7(VER 5.04)		
CLASS			VCCCPUCORE DECOUPLING		
THIS DOCUMENT IS THE PROPERTY OF IBM ITS USE IS AUTHORIZED ONLY FOR RESPONDING TO A REQUEST FOR QUOTATION OR FOR THE PERFORMANCE OF WORK FOR IBM. ALL QUESTIONS MUST BE REFERRED TO THE IBM PURCHASING DEPARTMENT.					LENOVO CONFIDENTIAL





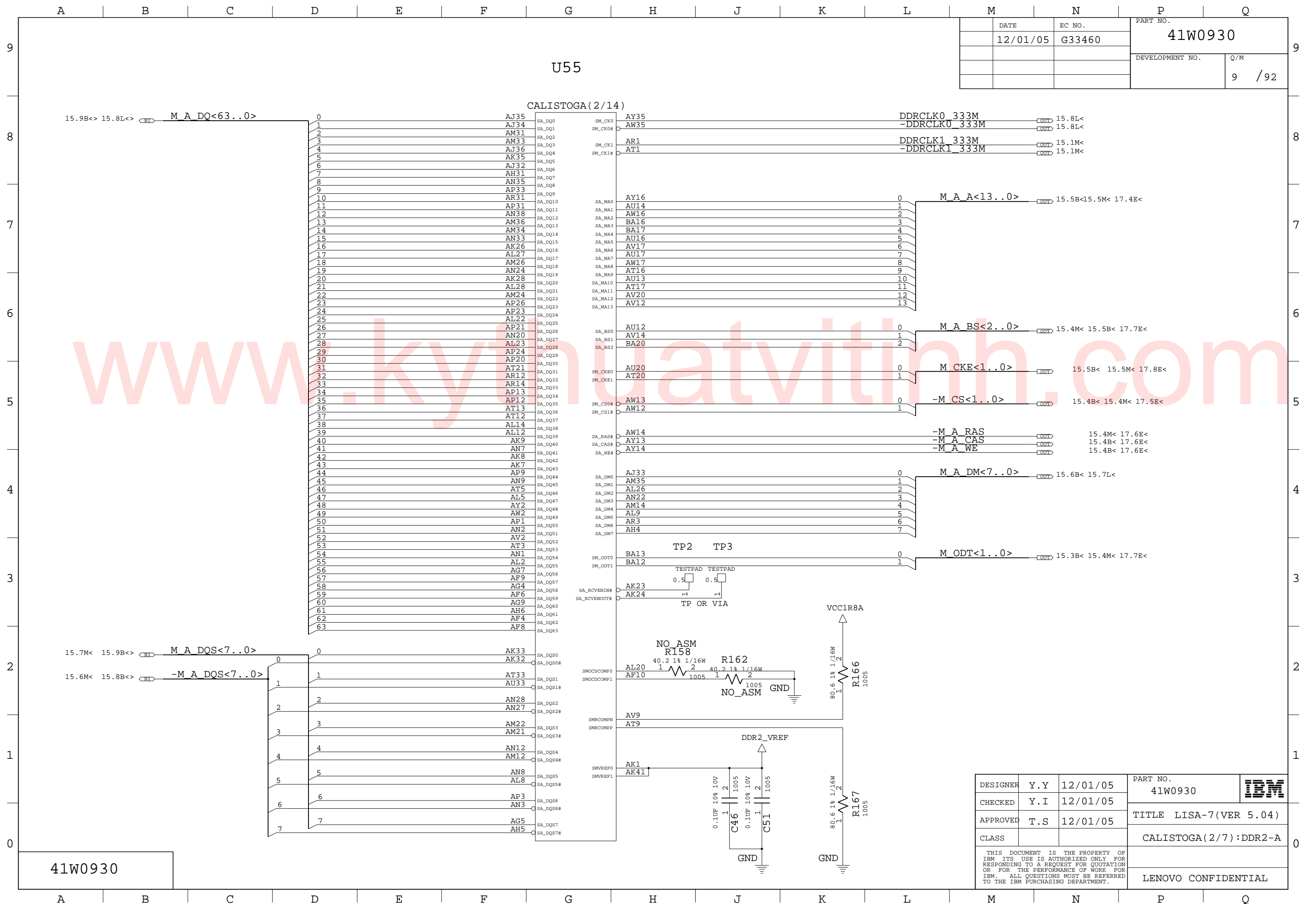

DATE	12/01/05	EC NO.	G33460	PART NO.	41W0930
DEVELOPMENT NO.				9	92

U55

CALISTOGA (2/14)

15.9B<> 15.8L<> M\_A DQ<63..0>

DDRCLK0\_333M  
-DDRCLK0\_333M  
DDRCLK1\_333M  
-DDRCLK1\_333M

M\_A A<13..0>

M\_A BS<2..0>

M\_CKE<1..0>

-M\_CS<1..0>

-M\_A RAS  
-M\_A CAS  
-M\_A WE

M\_A DM<7..0>

M\_ODT<1..0>

15.7M< 15.9B<> M\_A DQS<7..0>

15.6M< 15.8B<> -M\_A DQS<7..0>

NO\_ASM

R158

R162

NO\_ASM

DDR2\_VREF

41W0930

DESIGNER	Y.Y	12/01/05	PART NO.	41W0930	IBM
CHECKED	Y.I	12/01/05	TITLE LISA-7(VER 5.04)		
APPROVED	T.S	12/01/05	CALISTOGA (2/7) : DDR2-A		
THIS DOCUMENT IS THE PROPERTY OF IBM. ITS USE IS AUTHORIZED ONLY FOR RESPONDING TO A REQUEST FOR QUOTATION OR FOR THE PERFORMANCE OF WORK FOR IBM. ALL QUESTIONS MUST BE REFERRED TO THE IBM PURCHASING DEPARTMENT.					LENOVO CONFIDENTIAL

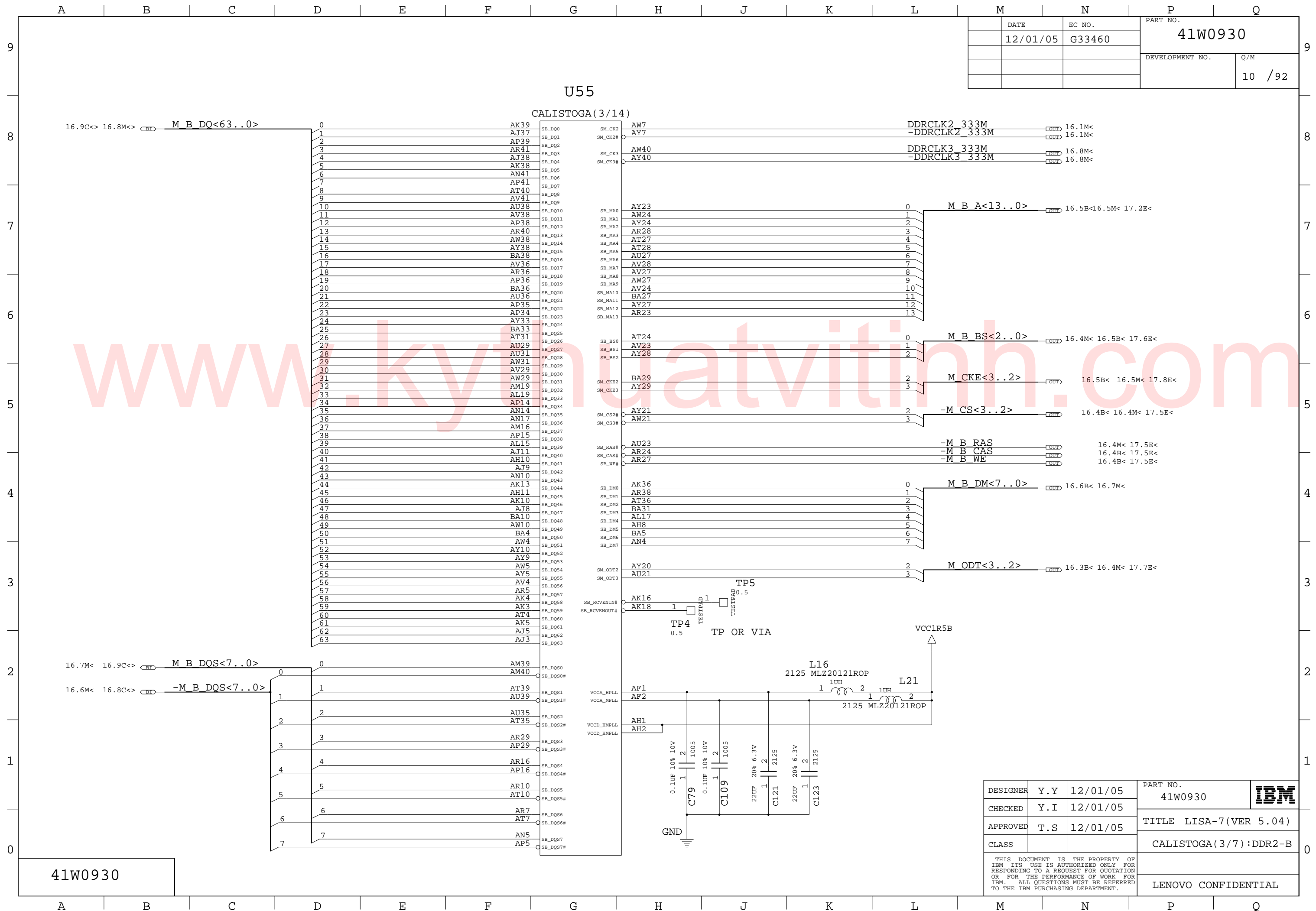

DATE	EC NO.	PART NO.	
12/01/05	G33460	41W0930	
		DEVELOPMENT NO.	Q/M
			10 /92

U55

CALISTOGA (3/14)

16.9C<> 16.8M<> M\_B DQ<63..0>

DDRCLK2\_333M  
-DDRCLK2\_333M  
DDRCLK3\_333M  
-DDRCLK3\_333M

M\_B A<13..0>

M\_B BS<2..0>

M\_CKE<3..2>

-M\_CS<3..2>

-M\_B RAS  
-M\_B CAS  
-M\_B WE

M\_B DM<7..0>

M\_ODT<3..2>

16.7M< 16.9C<> M\_B DQS<7..0>

16.6M< 16.8C<> -M\_B DQS<7..0>

41W0930

DESIGNER	Y.Y	12/01/05	PART NO.	41W0930	<b>IBM</b>
CHECKED	Y.I	12/01/05	TITLE LISA-7(VER 5.04)		
APPROVED	T.S	12/01/05	CALISTOGA (3/7) :DDR2-B		
CLASS			LENOVO CONFIDENTIAL		

THIS DOCUMENT IS THE PROPERTY OF IBM. ITS USE IS AUTHORIZED ONLY FOR RESPONDING TO A REQUEST FOR QUOTATION OR FOR THE PERFORMANCE OF WORK FOR IBM. ALL QUESTIONS MUST BE REFERRED TO THE IBM PURCHASING DEPARTMENT.

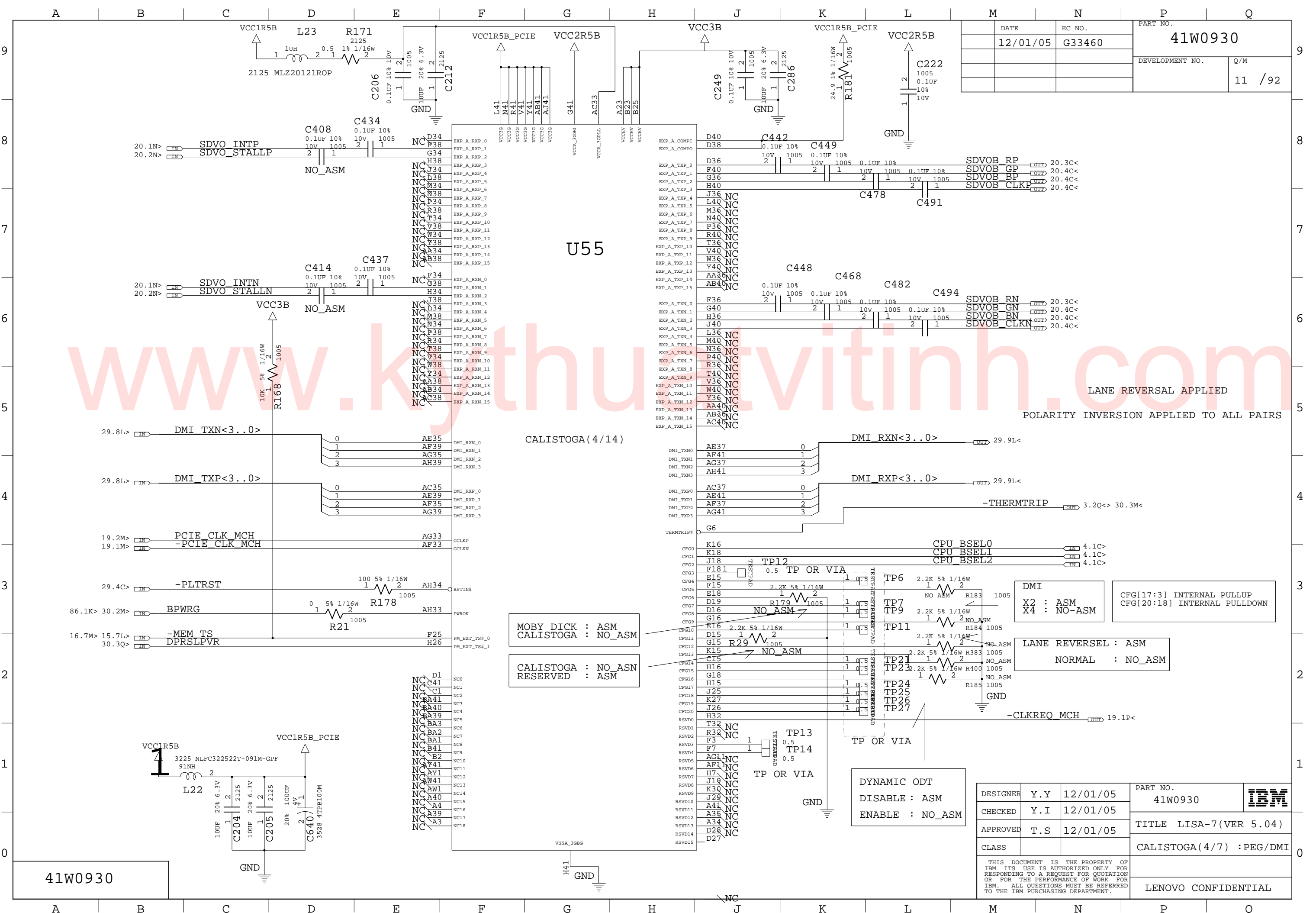

DATE	EC NO.	PART NO.
12/01/05	G33460	41W0930
DEVELOPMENT NO.		Q/M
		11 / 92

**U55**

**CALISTOGA (4/14)**

EXP_A_RXP_0	D34
EXP_A_RXP_1	F38
EXP_A_RXP_2	G34
EXP_A_RXP_3	H38
EXP_A_RXP_4	J34
EXP_A_RXP_5	B38
EXP_A_RXP_6	M34
EXP_A_RXP_7	N38
EXP_A_RXP_8	P34
EXP_A_RXP_9	R38
EXP_A_RXP_10	T34
EXP_A_RXP_11	V38
EXP_A_RXP_12	W34
EXP_A_RXP_13	Y38
EXP_A_RXP_14	AB34
EXP_A_RXP_15	BB38
EXP_A_RXN_0	F34
EXP_A_RXN_1	G38
EXP_A_RXN_2	H34
EXP_A_RXN_3	J38
EXP_A_RXN_4	M38
EXP_A_RXN_5	N34
EXP_A_RXN_6	P38
EXP_A_RXN_7	R34
EXP_A_RXN_8	T38
EXP_A_RXN_9	V34
EXP_A_RXN_10	W38
EXP_A_RXN_11	Y34
EXP_A_RXN_12	AB38
EXP_A_RXN_13	BB34
EXP_A_RXN_14	CB38
EXP_A_RXN_15	DB34
EXP_A_TXP_0	D40
EXP_A_TXP_1	F40
EXP_A_TXP_2	G36
EXP_A_TXP_3	H40
EXP_A_TXP_4	J36
EXP_A_TXP_5	L40
EXP_A_TXP_6	M36
EXP_A_TXP_7	N40
EXP_A_TXP_8	P36
EXP_A_TXP_9	R40
EXP_A_TXP_10	T36
EXP_A_TXP_11	V40
EXP_A_TXP_12	W36
EXP_A_TXP_13	Y40
EXP_A_TXP_14	AA36
EXP_A_TXP_15	AB40
EXP_A_TXN_0	F36
EXP_A_TXN_1	G40
EXP_A_TXN_2	H36
EXP_A_TXN_3	J40
EXP_A_TXN_4	L36
EXP_A_TXN_5	M40
EXP_A_TXN_6	N36
EXP_A_TXN_7	P40
EXP_A_TXN_8	R36
EXP_A_TXN_9	T40
EXP_A_TXN_10	V36
EXP_A_TXN_11	W40
EXP_A_TXN_12	Y36
EXP_A_TXN_13	AA40
EXP_A_TXN_14	AB40
EXP_A_TXN_15	AC40

MOBY DICK : ASM  
CALISTOGA : NO\_ASM

CALISTOGA : NO\_ASM  
RESERVED : ASM

DMIT  
X2 : ASM  
X4 : NO-ASM

CFG[17:3] INTERNAL PULLUP  
CFG[20:18] INTERNAL PULLDOWN

LANE REVERSEL : ASM  
NORMAL : NO\_ASM

DYNAMIC ODT  
DISABLE : ASM  
ENABLE : NO\_ASM

DESIGNER	Y.Y	12/01/05	PART NO.	41W0930	
CHECKED	Y.I	12/01/05	TITLE	LISA-7(VER 5.04)	
APPROVED	T.S	12/01/05	CALISTOGA(4/7) : PEG/DMI		
CLASS			LENOVO CONFIDENTIAL		

THIS DOCUMENT IS THE PROPERTY OF IBM ITS USE IS AUTHORIZED ONLY FOR RESPONDING TO A REQUEST FOR QUOTATION OR FOR THE PERFORMANCE OF WORK FOR IBM. ALL QUESTIONS MUST BE REFERRED TO THE IBM PURCHASING DEPARTMENT.

41W0930

LANE REVERSAL APPLIED  
POLARITY INVERSION APPLIED TO ALL PAIRS

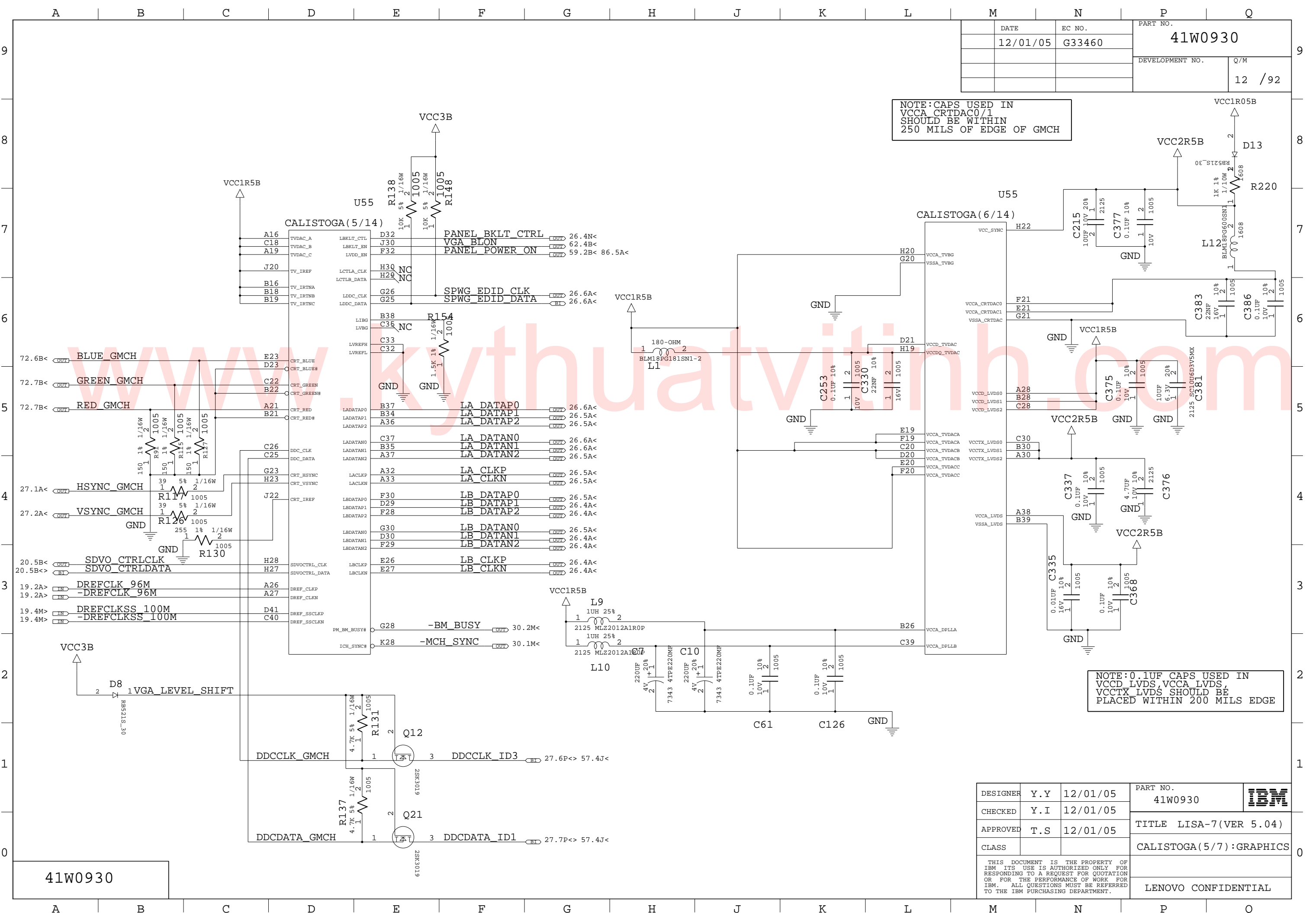

DATE	EC NO.	PART NO.
12/01/05	G33460	41W0930
DEVELOPMENT NO.		Q/M
		12 / 92

NOTE: CAPS USED IN VCCA\_CRTDAC0/1 SHOULD BE WITHIN 250 MILS OF EDGE OF GMCH

NOTE: 0.1UF CAPS USED IN VCCD LVDS, VCCA LVDS, VCCCTX LVDS SHOULD BE PLACED WITHIN 200 MILS EDGE

41W0930

DESIGNER	Y.Y	12/01/05	PART NO.	41W0930	<b>IBM</b>
CHECKED	Y.I	12/01/05	TITLE LISA-7(VER 5.04)		
APPROVED	T.S	12/01/05	CLASS CALISTOGA(5/7):GRAPHICS		LENOVO CONFIDENTIAL
THIS DOCUMENT IS THE PROPERTY OF IBM ITS USE IS AUTHORIZED ONLY FOR RESPONDING TO A REQUEST FOR QUOTATION OR FOR THE PERFORMANCE OF WORK FOR IBM. ALL QUESTIONS MUST BE REFERRED TO THE IBM PURCHASING DEPARTMENT.					

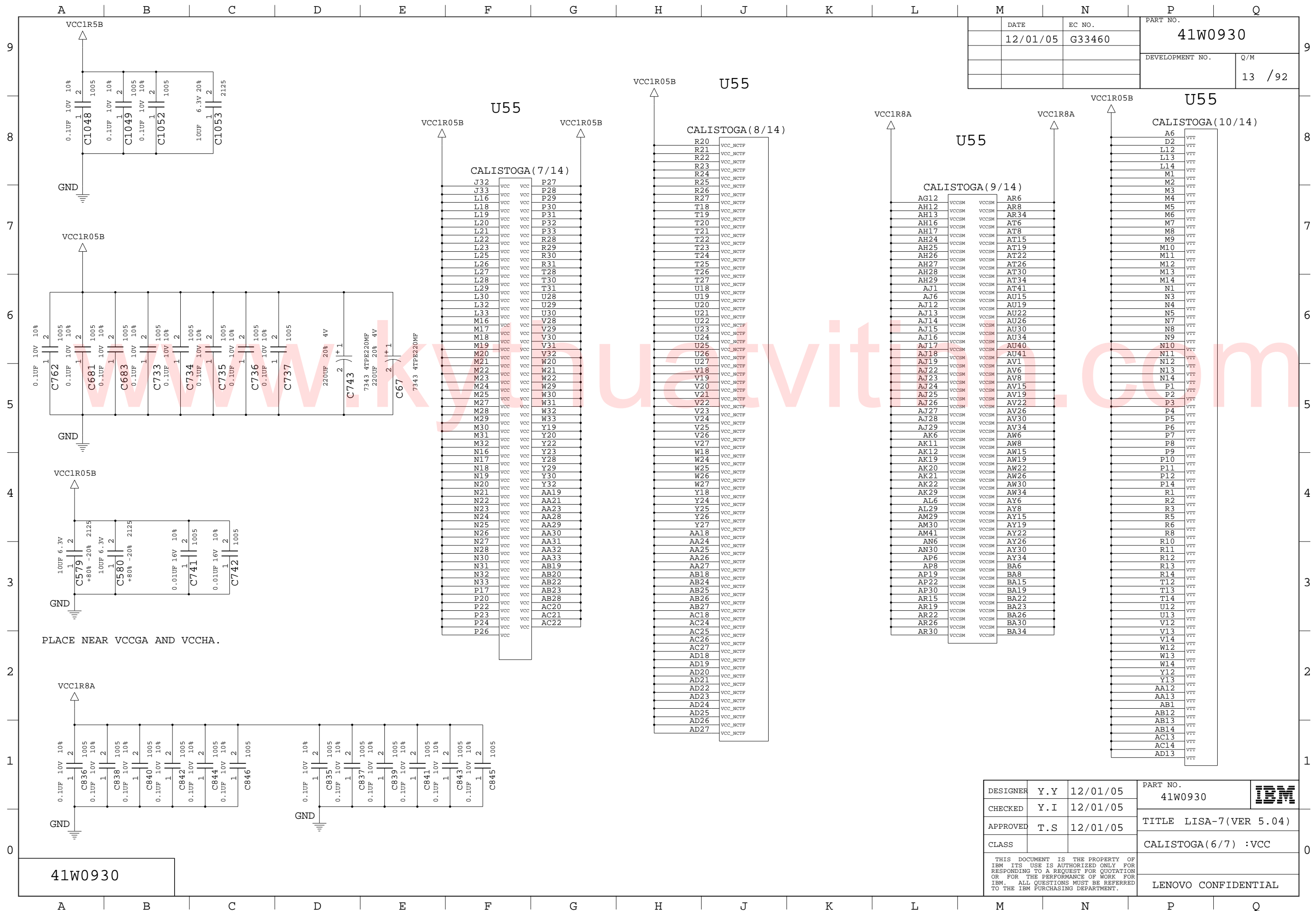

DATE	EC NO.	PART NO.	
12/01/05	G33460	41W0930	
		DEVELOPMENT NO.	Q/M
			13 / 92

**U55 CALISTOGA (7/14)**

J32	VCC	P27
J33	VCC	P28
L16	VCC	P29
L18	VCC	P30
L19	VCC	P31
L20	VCC	P32
L21	VCC	P33
L22	VCC	R28
L23	VCC	R29
L25	VCC	R30
L26	VCC	R31
L27	VCC	T28
L28	VCC	T30
L29	VCC	T31
L30	VCC	U28
L32	VCC	U29
L33	VCC	U30
M16	VCC	V28
M17	VCC	V29
M18	VCC	V30
M19	VCC	V31
M20	VCC	V32
M21	VCC	W20
M22	VCC	W21
M23	VCC	W22
M24	VCC	W29
M25	VCC	W30
M27	VCC	W31
M28	VCC	W32
M29	VCC	W33
M30	VCC	Y19
M31	VCC	Y20
M32	VCC	Y22
N16	VCC	Y23
N17	VCC	Y28
N18	VCC	Y29
N19	VCC	Y30
N20	VCC	Y32
N21	VCC	AA19
N22	VCC	AA21
N23	VCC	AA23
N24	VCC	AA28
N25	VCC	AA29
N26	VCC	AA30
N27	VCC	AA31
N28	VCC	AA32
N30	VCC	AA33
N31	VCC	AA27
N32	VCC	AB20
N33	VCC	AB22
P17	VCC	AB23
P20	VCC	AB28
P22	VCC	AC20
P23	VCC	AC21
P24	VCC	AC24
P26	VCC	AC22

**U55 CALISTOGA (8/14)**

R20	VCC_NCTF
R21	VCC_NCTF
R22	VCC_NCTF
R23	VCC_NCTF
R24	VCC_NCTF
R25	VCC_NCTF
R26	VCC_NCTF
R27	VCC_NCTF
T18	VCC_NCTF
T19	VCC_NCTF
T20	VCC_NCTF
T21	VCC_NCTF
T22	VCC_NCTF
T23	VCC_NCTF
T24	VCC_NCTF
T25	VCC_NCTF
T26	VCC_NCTF
T27	VCC_NCTF
U18	VCC_NCTF
U19	VCC_NCTF
U20	VCC_NCTF
U21	VCC_NCTF
U22	VCC_NCTF
U23	VCC_NCTF
U24	VCC_NCTF
U25	VCC_NCTF
U26	VCC_NCTF
U27	VCC_NCTF
V18	VCC_NCTF
V19	VCC_NCTF
V20	VCC_NCTF
V21	VCC_NCTF
V22	VCC_NCTF
V23	VCC_NCTF
V24	VCC_NCTF
V25	VCC_NCTF
V26	VCC_NCTF
V27	VCC_NCTF
W18	VCC_NCTF
W24	VCC_NCTF
W25	VCC_NCTF
W26	VCC_NCTF
W27	VCC_NCTF
Y18	VCC_NCTF
Y24	VCC_NCTF
Y25	VCC_NCTF
Y26	VCC_NCTF
Y27	VCC_NCTF
AA18	VCC_NCTF
AA24	VCC_NCTF
AA32	VCC_NCTF
AA33	VCC_NCTF
AA27	VCC_NCTF
AB18	VCC_NCTF
AB24	VCC_NCTF
AB25	VCC_NCTF
AB26	VCC_NCTF
AB27	VCC_NCTF
AC18	VCC_NCTF
AC24	VCC_NCTF
AC25	VCC_NCTF
AC26	VCC_NCTF
AC27	VCC_NCTF
AD18	VCC_NCTF
AD19	VCC_NCTF
AD20	VCC_NCTF
AD21	VCC_NCTF
AD22	VCC_NCTF
AD23	VCC_NCTF
AD24	VCC_NCTF
AD25	VCC_NCTF
AD26	VCC_NCTF
AD27	VCC_NCTF

**U55 CALISTOGA (9/14)**

AG12	VCCSM	AR6
AH12	VCCSM	AR8
AH13	VCCSM	AR34
AH16	VCCSM	AT6
AH17	VCCSM	AT8
AH24	VCCSM	AT15
AH25	VCCSM	AT19
AH26	VCCSM	AT22
AH27	VCCSM	AT26
AH28	VCCSM	AT30
AH29	VCCSM	AT34
AJ1	VCCSM	AT41
AJ6	VCCSM	AU15
AJ12	VCCSM	AU19
AJ13	VCCSM	AU22
AJ14	VCCSM	AU26
AJ15	VCCSM	AU30
AJ16	VCCSM	AU34
AJ17	VCCSM	AU40
AJ18	VCCSM	AU41
AJ19	VCCSM	AV1
AJ22	VCCSM	AV6
AJ23	VCCSM	AV8
AJ24	VCCSM	AV15
AJ25	VCCSM	AV19
AJ26	VCCSM	AV22
AJ27	VCCSM	AV26
AJ29	VCCSM	AV30
AK6	VCCSM	AW6
AK11	VCCSM	AW8
AK12	VCCSM	AW15
AK19	VCCSM	AW19
AK20	VCCSM	AW22
AK21	VCCSM	AW26
AK22	VCCSM	AW30
AK29	VCCSM	AW34
AL6	VCCSM	AY6
AL29	VCCSM	AY8
AM29	VCCSM	AY15
AM30	VCCSM	AY19
AM41	VCCSM	AY22
AN6	VCCSM	AY26
AN30	VCCSM	AY30
AP6	VCCSM	AY34
AP8	VCCSM	BA6
AP19	VCCSM	BA8
AP22	VCCSM	BA15
AP30	VCCSM	BA19
AR15	VCCSM	BA22
AR19	VCCSM	BA23
AR22	VCCSM	BA26
AR26	VCCSM	BA30
AR30	VCCSM	BA34

**U55 CALISTOGA (10/14)**

A6	VTT
D2	VTT
L12	VTT
L13	VTT
L14	VTT
M1	VTT
M2	VTT
M3	VTT
M4	VTT
M5	VTT
M6	VTT
M7	VTT
M8	VTT
M9	VTT
M10	VTT
M11	VTT
M12	VTT
M13	VTT
M14	VTT
N1	VTT
N3	VTT
N4	VTT
N5	VTT
N7	VTT
N8	VTT
N9	VTT
N10	VTT
N11	VTT
N12	VTT
N13	VTT
N14	VTT
P1	VTT
P2	VTT
P3	VTT
P4	VTT
P5	VTT
P6	VTT
P7	VTT
P8	VTT
P9	VTT
P10	VTT
P11	VTT
P12	VTT
P14	VTT
R1	VTT
R2	VTT
R3	VTT
R5	VTT
R6	VTT
R8	VTT
R10	VTT
R11	VTT
R12	VTT
R13	VTT
R14	VTT
T12	VTT
T13	VTT
T14	VTT
U12	VTT
U13	VTT
V13	VTT
V14	VTT
W12	VTT
W13	VTT
W14	VTT
Y12	VTT
Y13	VTT
AA12	VTT
AA13	VTT
AB1	VTT
AB12	VTT
AB13	VTT
AB14	VTT
AC13	VTT
AC14	VTT
AD13	VTT

PLACE NEAR VCCGA AND VCCHA.

DESIGNER	Y.Y	12/01/05	PART NO.	41W0930	
CHECKED	Y.I	12/01/05	TITLE		
APPROVED	T.S	12/01/05	CLASS CALISTOGA(6/7) :VCC		
THIS DOCUMENT IS THE PROPERTY OF IBM ITS USE IS AUTHORIZED ONLY FOR RESPONDING TO A REQUEST FOR QUOTATION OR FOR THE PERFORMANCE OF WORK FOR IBM. ALL QUESTIONS MUST BE REFERRED TO THE IBM PURCHASING DEPARTMENT.					LENOVO CONFIDENTIAL

41W0930



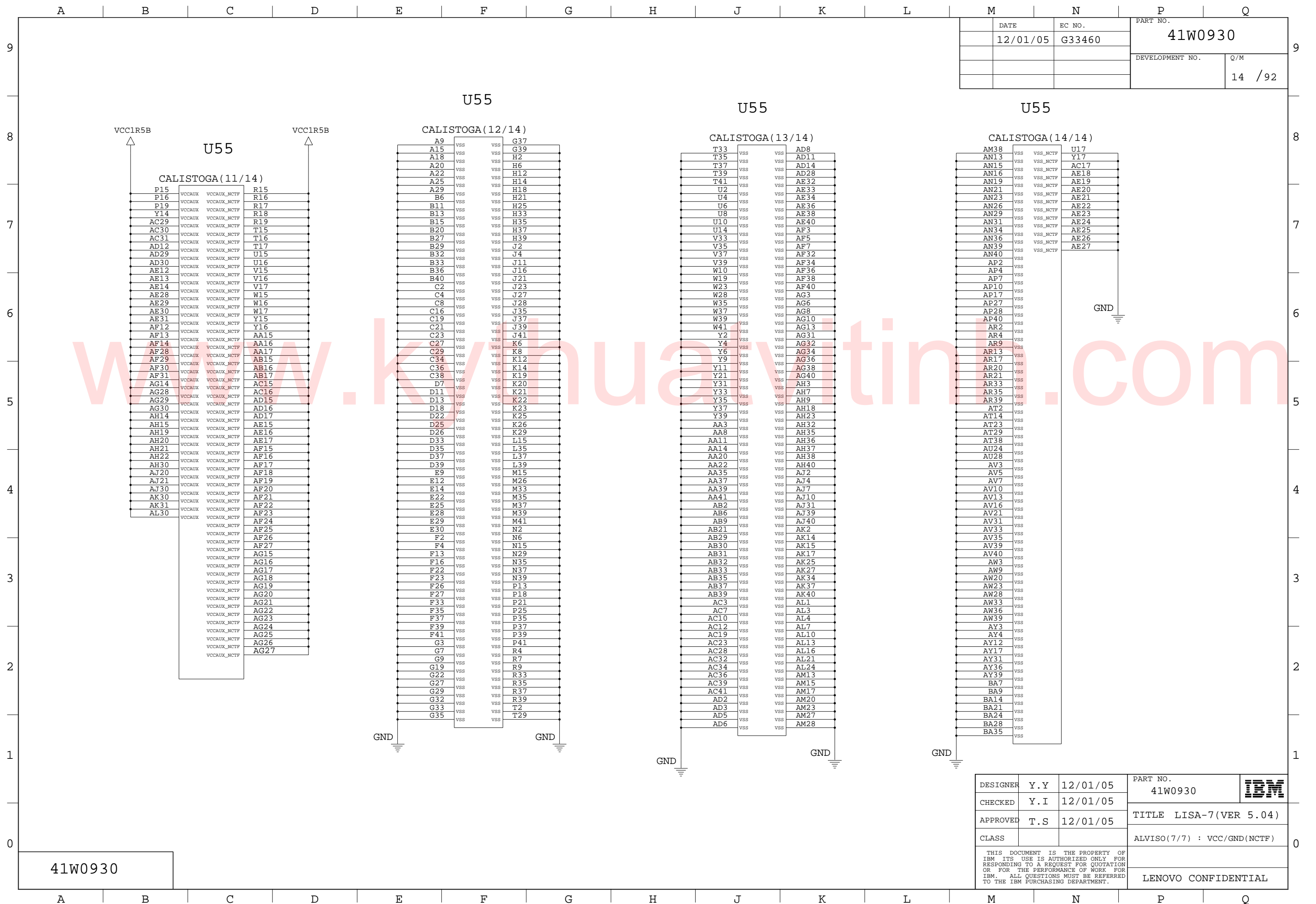

DATE	EC NO.	PART NO.	
12/01/05	G33460	41W0930	
		DEVELOPMENT NO.	Q/M
			14 / 92

41W0930

DESIGNER	Y. Y	12/01/05	PART NO.	41W0930	
CHECKED	Y. I	12/01/05	TITLE		
APPROVED	T. S	12/01/05	ALVISO(7/7) : VCC/GND(NCTF)		
CLASS			THIS DOCUMENT IS THE PROPERTY OF IBM ITS USE IS AUTHORIZED ONLY FOR RESPONDING TO A REQUEST FOR QUOTATION OR FOR THE PERFORMANCE OF WORK FOR IBM. ALL QUESTIONS MUST BE REFERRED TO THE IBM PURCHASING DEPARTMENT.		
			LENOVO CONFIDENTIAL		



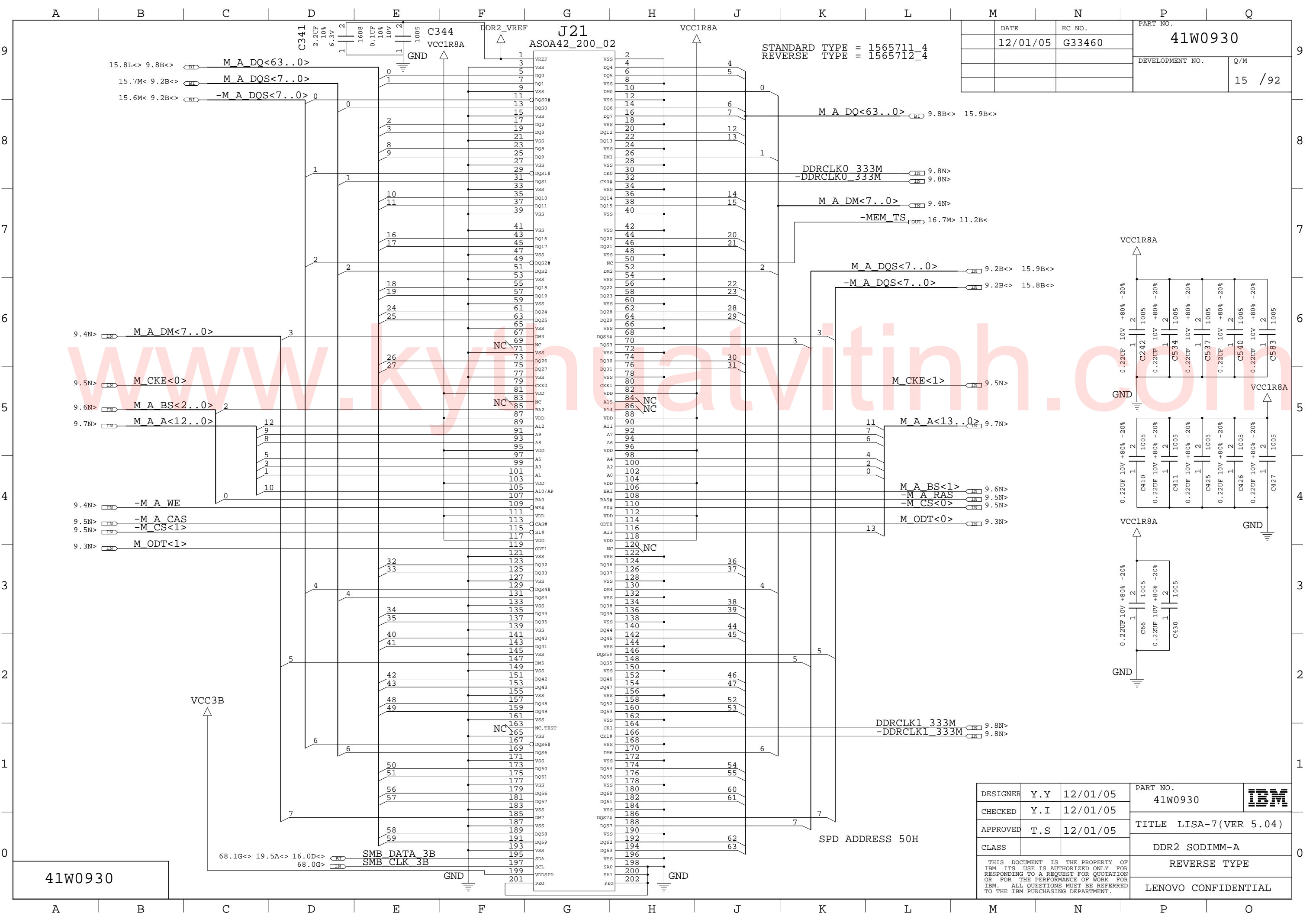

DATE	12/01/05	EC NO.	G33460	PART NO.	41W0930
				DEVELOPMENT NO.	Q/M
					15 / 92

STANDARD TYPE = 1565711\_4  
 REVERSE TYPE = 1565712\_4

DESIGNER	Y.Y	12/01/05	PART NO.	41W0930	
CHECKED	Y.I	12/01/05	TITLE LISA-7(VER 5.04)		
APPROVED	T.S	12/01/05	DDR2 SODIMM-A		
CLASS			REVERSE TYPE		
THIS DOCUMENT IS THE PROPERTY OF IBM ITS USE IS AUTHORIZED ONLY FOR RESPONDING TO A REQUEST FOR QUOTATION OR FOR THE PERFORMANCE OF WORK FOR IBM. ALL QUESTIONS MUST BE REFERRED TO THE IBM PURCHASING DEPARTMENT.					LENOVO CONFIDENTIAL

41W0930

SPD ADDRESS 50H

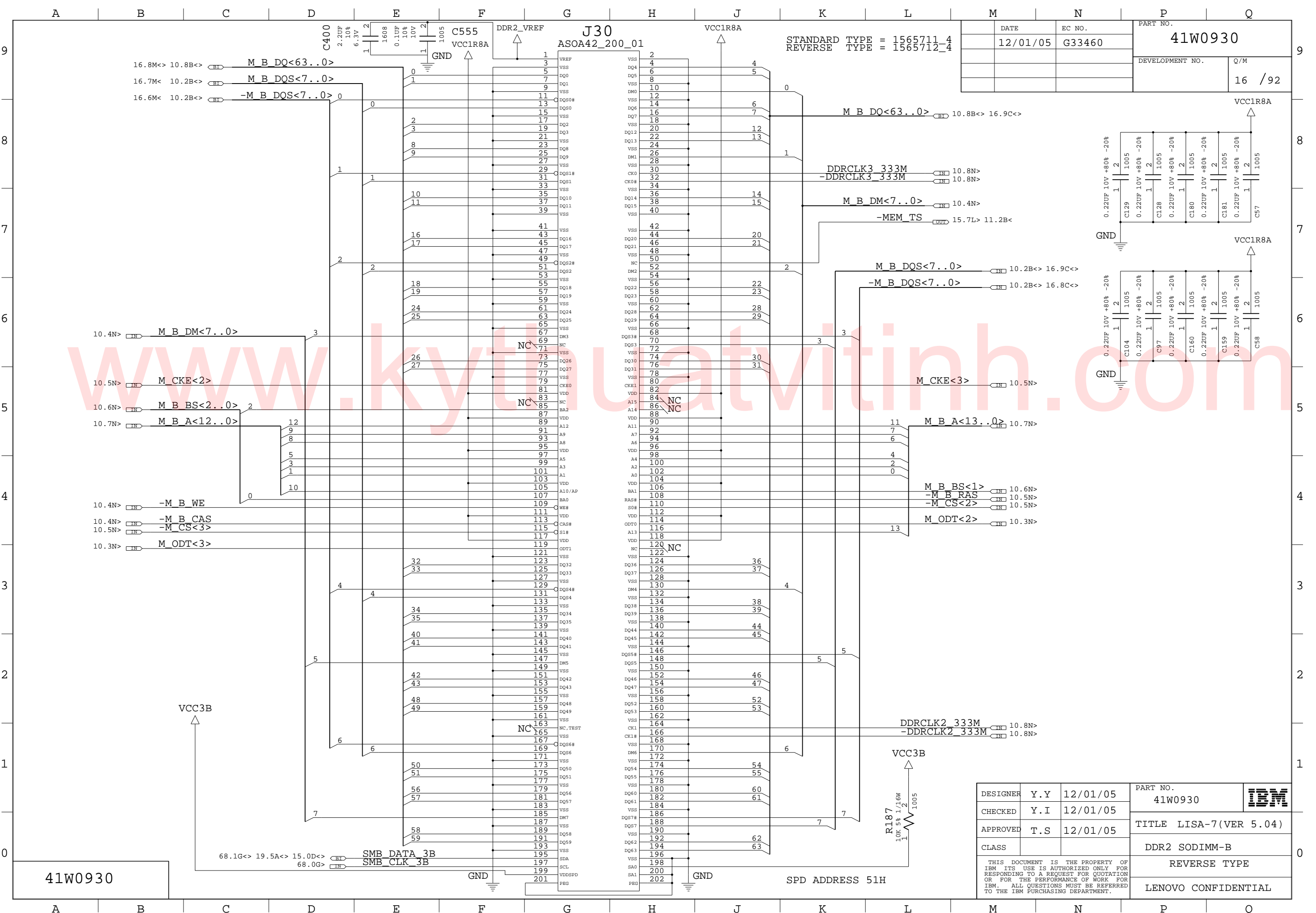

DATE	12/01/05	EC NO.	G33460	PART NO.	41W0930
				DEVELOPMENT NO.	Q/M
					16 / 92

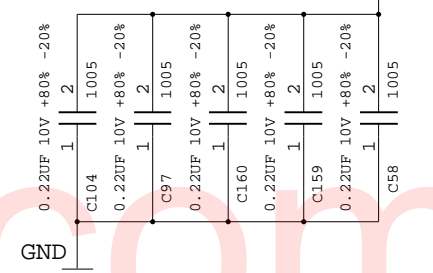
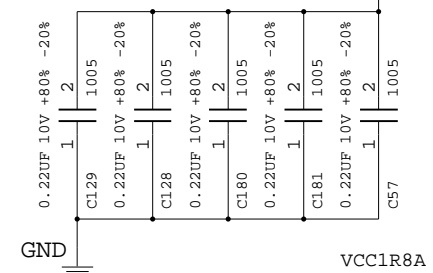

DESIGNER	Y.Y	12/01/05	PART NO.	41W0930	
CHECKED	Y.I	12/01/05	TITLE LISA-7(VER 5.04)		
APPROVED	T.S	12/01/05	DDR2 SODIMM-B		
CLASS			REVERSE TYPE		
THIS DOCUMENT IS THE PROPERTY OF IBM ITS USE IS AUTHORIZED ONLY FOR RESPONDING TO A REQUEST FOR QUOTATION OR FOR THE PERFORMANCE OF WORK FOR IBM. ALL QUESTIONS MUST BE REFERRED TO THE IBM PURCHASING DEPARTMENT.					LENOVO CONFIDENTIAL

41W0930

SPD ADDRESS 51H

DATE	12/01/05	EC NO.	G33460	PART NO.	41W0930	
DEVELOPMENT NO.			Q/M			
			17 /92			

9  
8  
7  
6  
5  
4  
3  
2  
1  
0

9  
8  
7  
6  
5  
4  
3  
2  
1  
0

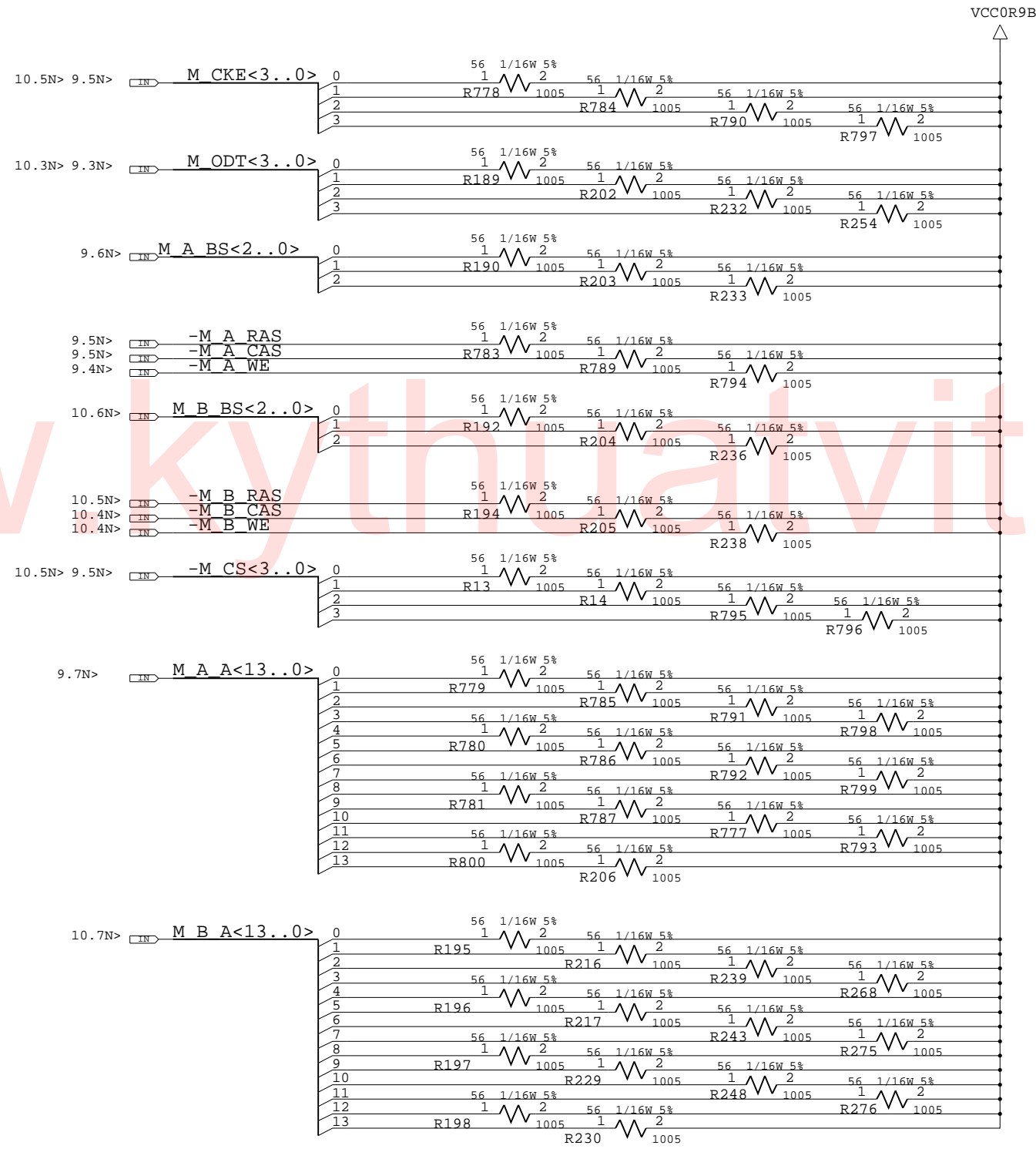

41W0930

DESIGNER	Y.Y	12/01/05	PART NO.	41W0930	<b>IBM</b>
CHECKED	Y.I	12/01/05	TITLE LISA-7(VER 5.04)		
APPROVED	T.S	12/01/05	DDR-2 TERMINATION		
CLASS			LENOVO CONFIDENTIAL		
<small>THIS DOCUMENT IS THE PROPERTY OF IBM. ITS USE IS AUTHORIZED ONLY FOR RESPONDING TO A REQUEST FOR QUOTATION OR FOR THE PERFORMANCE OF WORK FOR IBM. ALL QUESTIONS MUST BE REFERRED TO THE IBM PURCHASING DEPARTMENT.</small>					

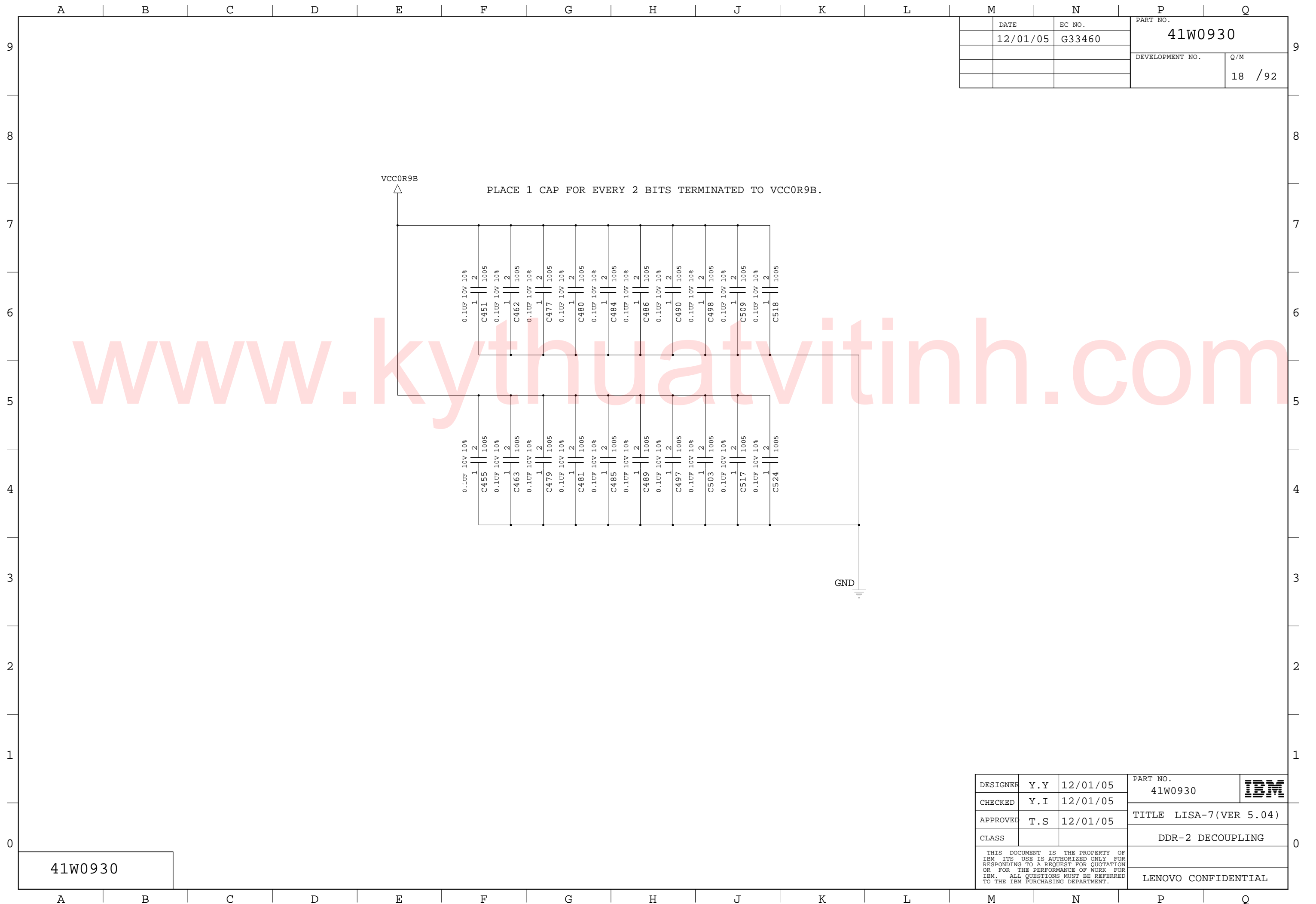

DATE	EC NO.	PART NO.	
12/01/05	G33460	41W0930	
		DEVELOPMENT NO.	Q/M
			18 /92

41W0930

DESIGNER	Y.Y	12/01/05	PART NO.	41W0930	<b>IBM</b>
CHECKED	Y.I	12/01/05			
APPROVED	T.S	12/01/05	TITLE LISA-7(VER 5.04)		
CLASS			DDR-2 DECOUPLING		
THIS DOCUMENT IS THE PROPERTY OF IBM ITS USE IS AUTHORIZED ONLY FOR RESPONDING TO A REQUEST FOR QUOTATION OR FOR THE PERFORMANCE OF WORK FOR IBM. ALL QUESTIONS MUST BE REFERRED TO THE IBM PURCHASING DEPARTMENT.				LENOVO CONFIDENTIAL	





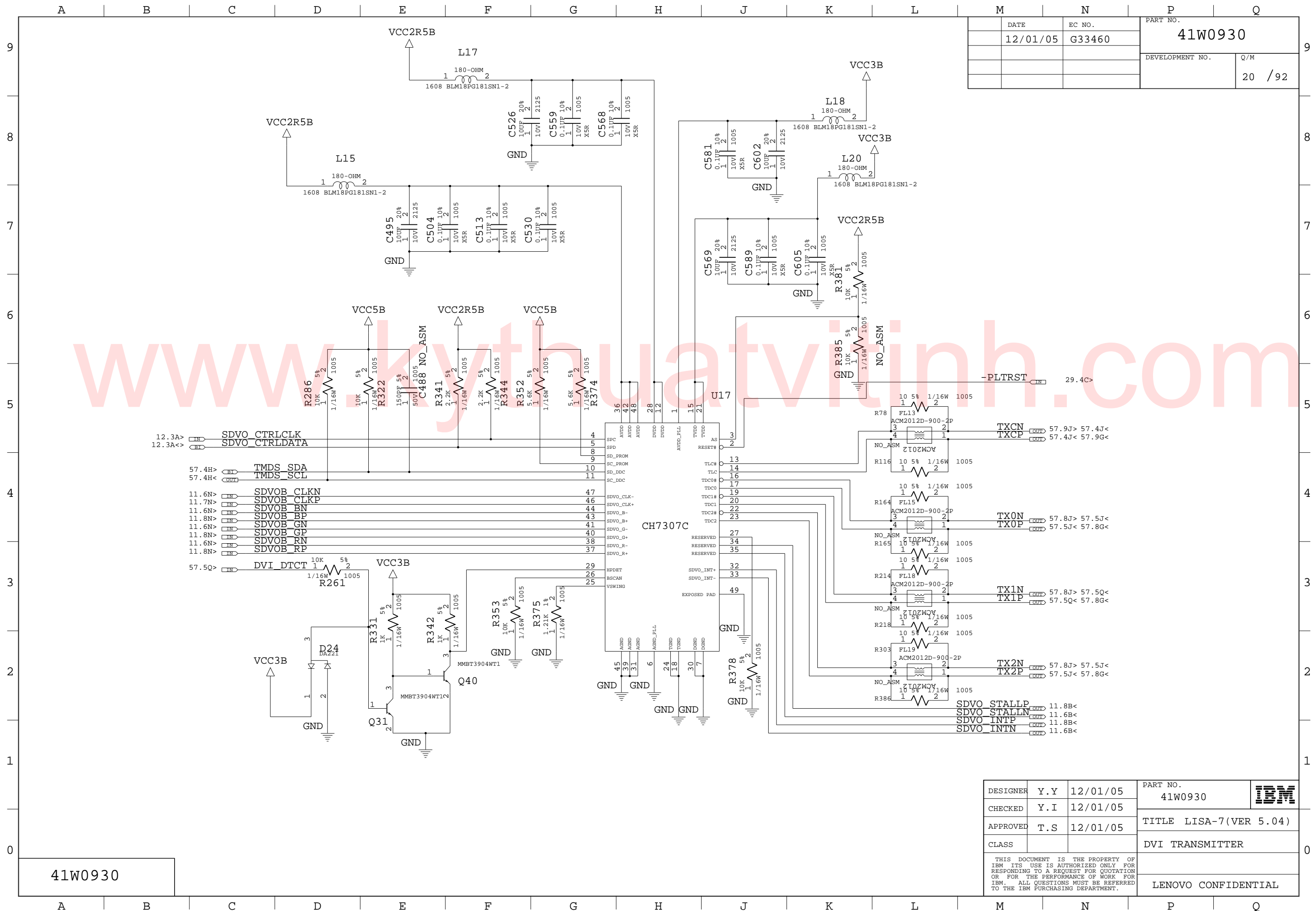

DATE	EC NO.	PART NO.	
12/01/05	G33460	41W0930	
		DEVELOPMENT NO.	Q/M
			20 / 92

41W0930

DESIGNER	Y.Y	12/01/05	PART NO.	41W0930	
CHECKED	Y.I	12/01/05			
APPROVED	T.S	12/01/05	TITLE LISA-7(VER 5.04)		
CLASS			DVI TRANSMITTER		
THIS DOCUMENT IS THE PROPERTY OF IBM ITS USE IS AUTHORIZED ONLY FOR RESPONDING TO A REQUEST FOR QUOTATION OR FOR THE PERFORMANCE OF WORK FOR IBM. ALL QUESTIONS MUST BE REFERRED TO THE IBM PURCHASING DEPARTMENT.				LENOVO CONFIDENTIAL	

















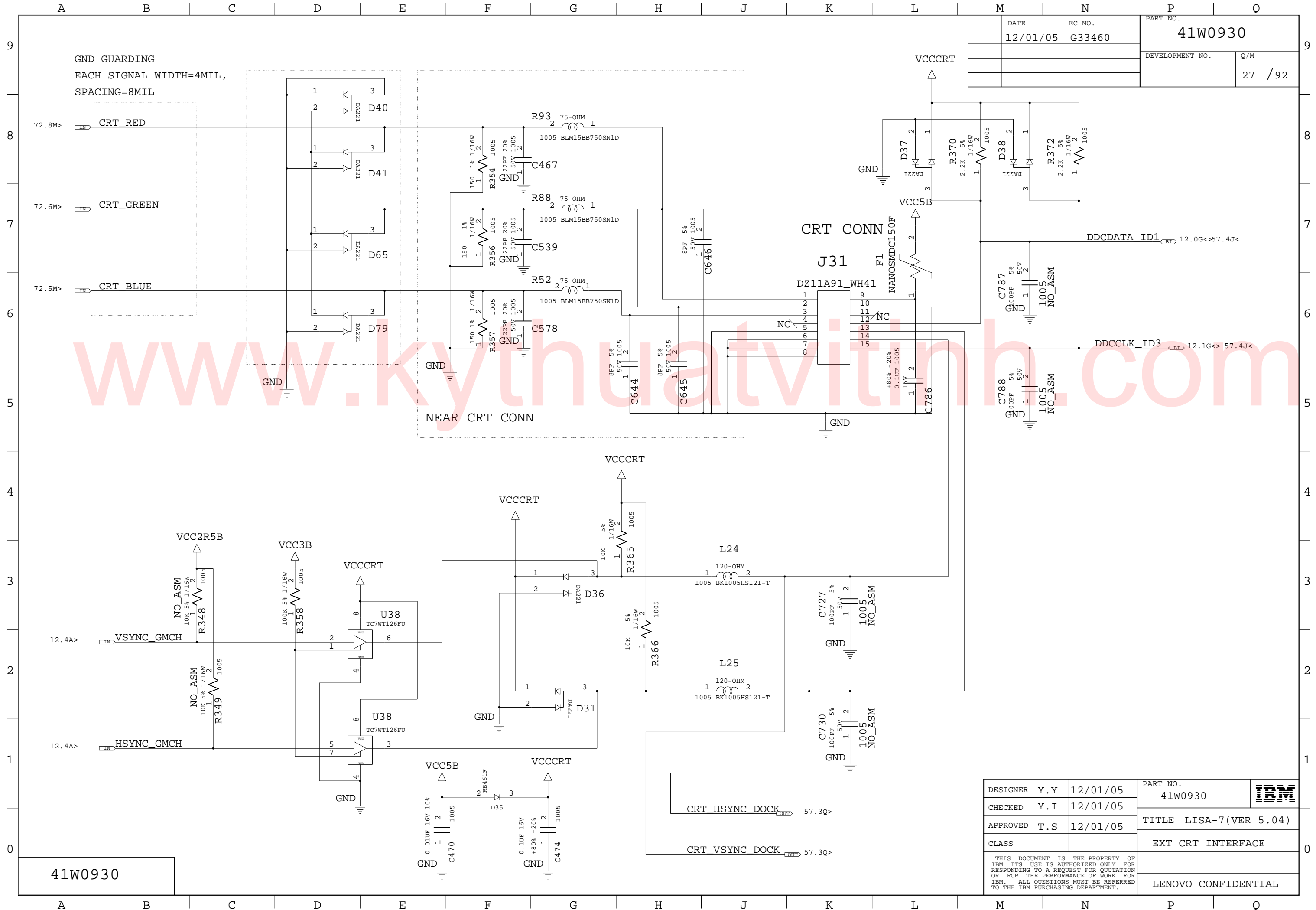

DATE	EC NO.	PART NO.
12/01/05	G33460	41W0930
DEVELOPMENT NO.		Q/M
		27 / 92

41W0930

DESIGNER	Y.Y	12/01/05	PART NO.	41W0930	IBM
CHECKED	Y.I	12/01/05	TITLE LISA-7(VER 5.04)		
APPROVED	T.S	12/01/05	EXT CRT INTERFACE		
CLASS			LENOVO CONFIDENTIAL		

THIS DOCUMENT IS THE PROPERTY OF IBM ITS USE IS AUTHORIZED ONLY FOR RESPONDING TO A REQUEST FOR QUOTATION OR FOR THE PERFORMANCE OF WORK FOR IBM. ALL QUESTIONS MUST BE REFERRED TO THE IBM PURCHASING DEPARTMENT.

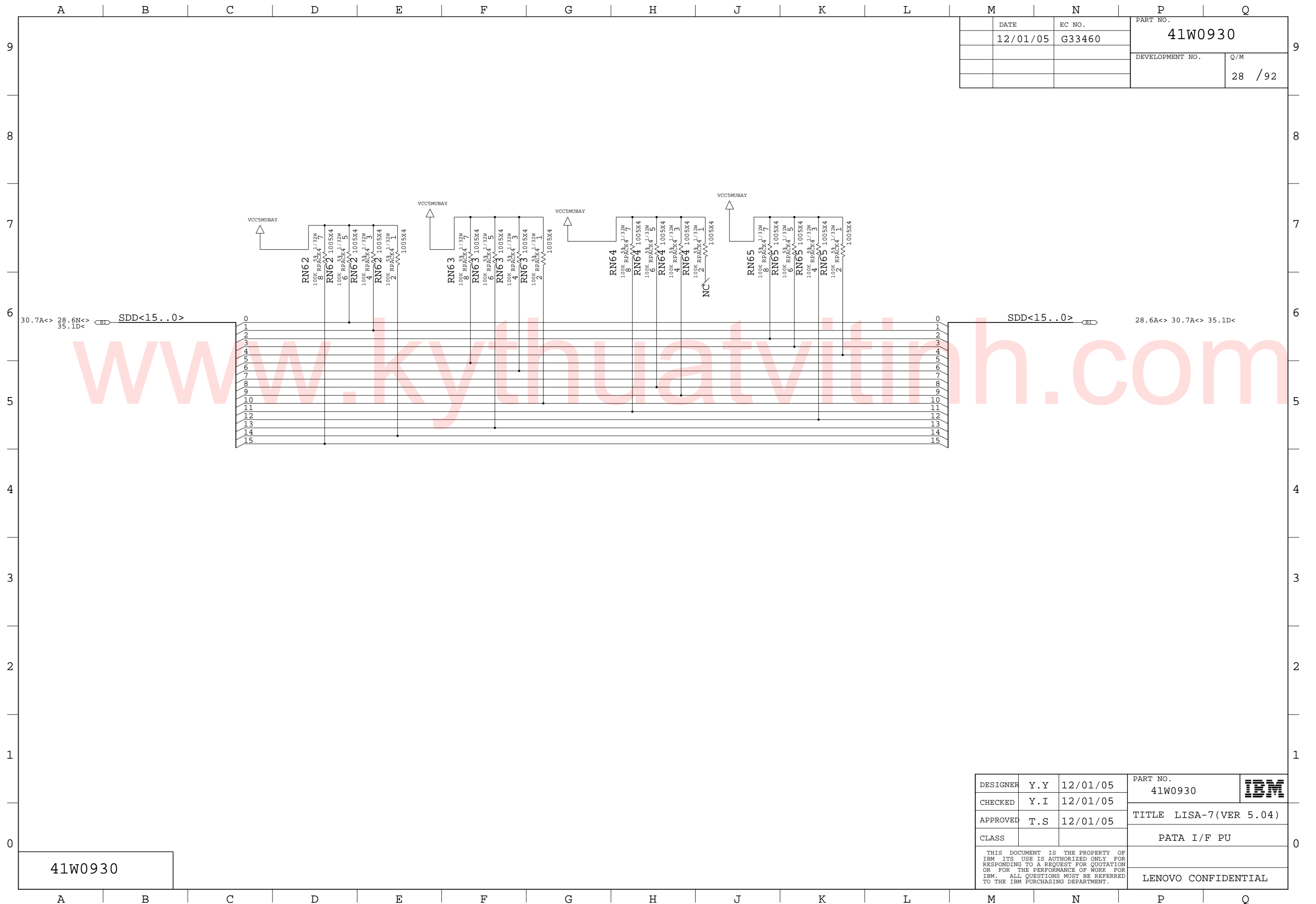

DATE	EC NO.	PART NO.	
12/01/05	G33460	41W0930	
		DEVELOPMENT NO.	Q/M
			28 /92

30.7A<> 28.6N<> 35.1D< SDD<15..0>

SDD<15..0> 28.6A<> 30.7A<> 35.1D<

41W0930

DESIGNER	Y.Y	12/01/05	PART NO.	41W0930	<b>IBM</b>
CHECKED	Y.I	12/01/05			
APPROVED	T.S	12/01/05	TITLE LISA-7(VER 5.04)		
CLASS			PATA I/F PU		
THIS DOCUMENT IS THE PROPERTY OF IBM ITS USE IS AUTHORIZED ONLY FOR RESPONDING TO A REQUEST FOR QUOTATION OR FOR THE PERFORMANCE OF WORK FOR IBM. ALL QUESTIONS MUST BE REFERRED TO THE IBM PURCHASING DEPARTMENT.				LENOVO CONFIDENTIAL	

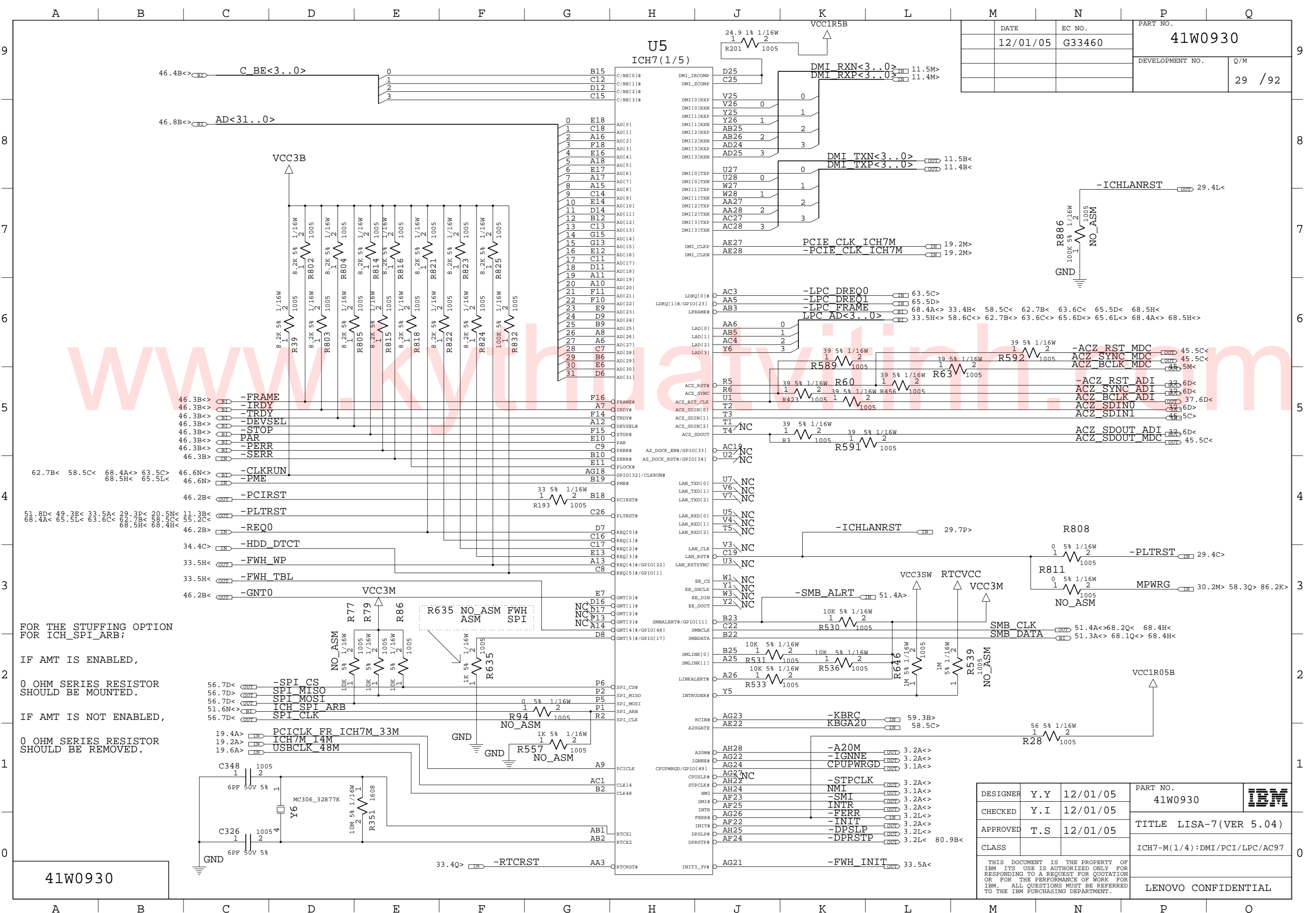

DATE	EC NO.	PART NO.
12/01/05	G33460	41W0930
DEVELOPMENT NO.		Q/M
		29 / 92

FOR THE STUFFING OPTION FOR ICH\_SPI\_ARB;

IF AMT IS ENABLED, 0 OHM SERIES RESISTOR SHOULD BE MOUNTED.

IF AMT IS NOT ENABLED, 0 OHM SERIES RESISTOR SHOULD BE REMOVED.

DESIGNER	Y.Y	12/01/05	PART NO.	41W0930	IBM
CHECKED	Y.I	12/01/05	TITLE LISA-7(VER 5.04)		
APPROVED	T.S	12/01/05	CLASS ICH7-M(1/4):DMI/PCI/LPC/AC97		LENOVO CONFIDENTIAL
THIS DOCUMENT IS THE PROPERTY OF IBM ITS USE IS AUTHORIZED ONLY FOR RESPONDING TO A REQUEST FOR QUOTATION OR FOR THE PERFORMANCE OF WORK FOR IBM. ALL QUESTIONS MUST BE REFERRED TO THE IBM PURCHASING DEPARTMENT.					

41W0930

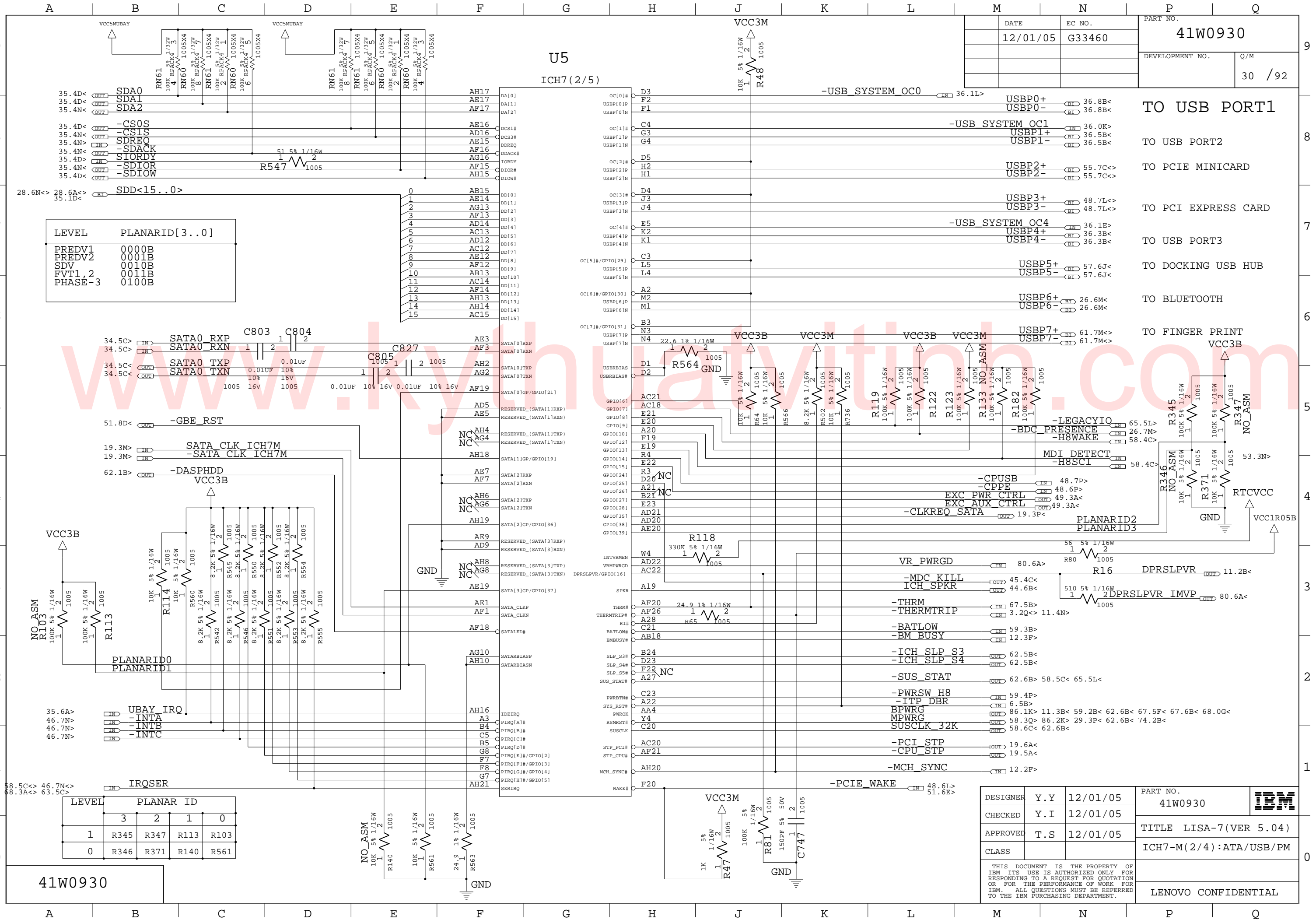

DATE	12/01/05	EC NO.	G33460	PART NO.	41W0930
DEVELOPMENT NO.				Q/M	
				30 / 92	

LEVEL	PLANARID[3..0]
PREDV1	0000B
PREDV2	0001B
SDV	0010B
FVT1,2	0011B
PHASE-3	0100B

NO_ASM	R103	R113	R114	R542	R544	R546	R551	R553	R554	R555
PLANARID0	100K 5% 1/16W	100K 5% 1/16W	10K 5% 1/16W	8.2K 5% 1/16W	8.2K 5% 1/16W	8.2K 5% 1/16W	8.2K 5% 1/16W	8.2K 5% 1/16W	8.2K 5% 1/16W	8.2K 5% 1/16W
PLANARID1	100K 5% 1/16W	100K 5% 1/16W	10K 5% 1/16W	8.2K 5% 1/16W	8.2K 5% 1/16W	8.2K 5% 1/16W	8.2K 5% 1/16W	8.2K 5% 1/16W	8.2K 5% 1/16W	8.2K 5% 1/16W

LEVEL	PLANAR ID
3	R345 R347 R113 R103
1	R345 R347 R113 R103
0	R346 R371 R140 R561

DESIGNER	Y.Y	12/01/05	PART NO.	41W0930	
CHECKED	Y.I	12/01/05	TITLE LISA-7(VER 5.04)		
APPROVED	T.S	12/01/05	ICH7-M(2/4):ATA/USB/PM		
CLASS	LENovo CONFIDENTIAL				

THIS DOCUMENT IS THE PROPERTY OF IBM ITS USE IS AUTHORIZED ONLY FOR RESPONDING TO A REQUEST FOR QUOTATION OR FOR THE PERFORMANCE OF WORK FOR IBM. ALL QUESTIONS MUST BE REFERRED TO THE IBM PURCHASING DEPARTMENT.

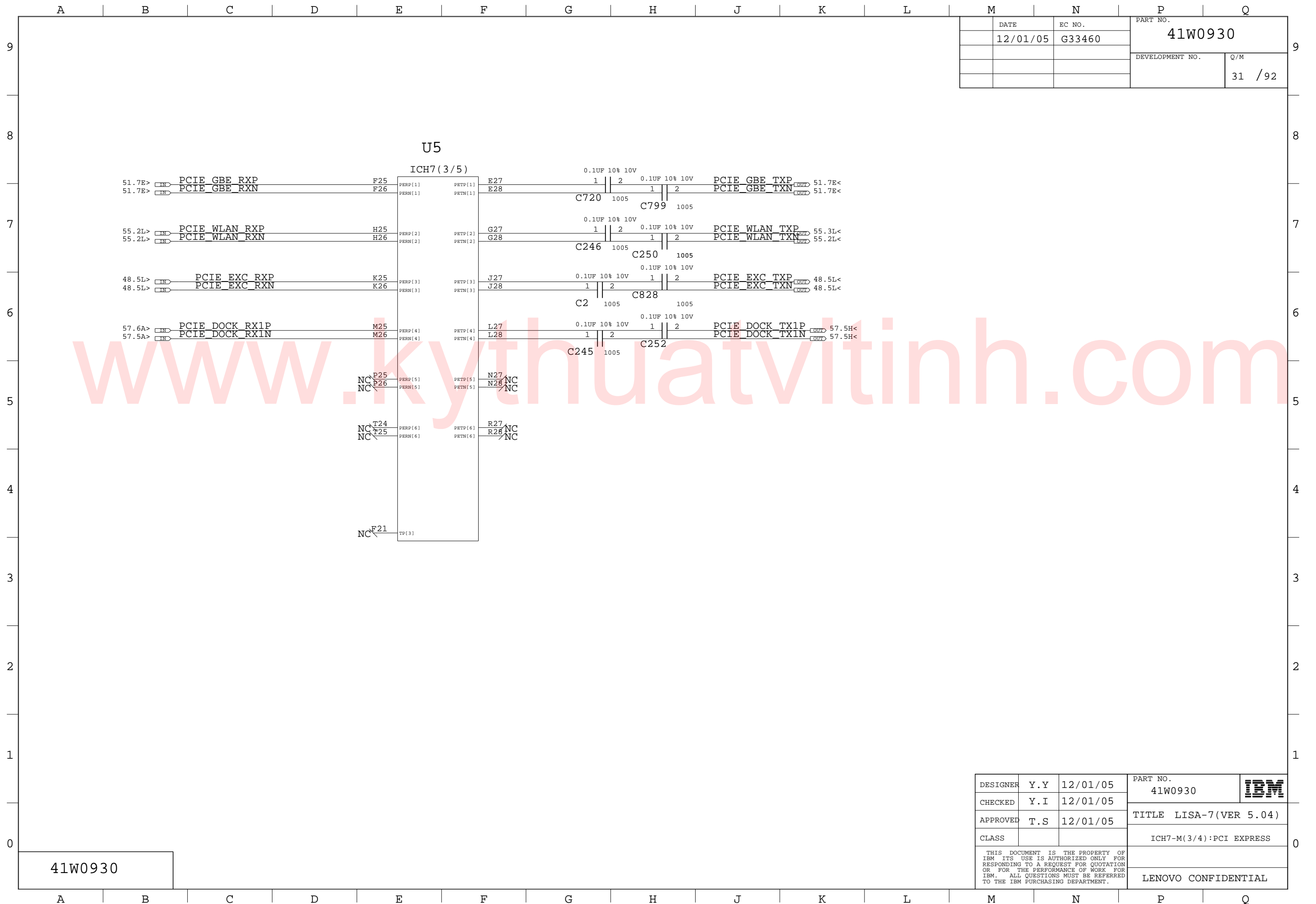

DATE	EC NO.	PART NO.	
12/01/05	G33460	41W0930	
		DEVELOPMENT NO.	Q/M
			31 / 92

41W0930

DESIGNER	Y.Y	12/01/05	PART NO.	41W0930	<b>IBM</b>
CHECKED	Y.I	12/01/05			
APPROVED	T.S	12/01/05	TITLE LISA-7(VER 5.04)		
CLASS			ICH7-M(3/4):PCI EXPRESS		
THIS DOCUMENT IS THE PROPERTY OF IBM ITS USE IS AUTHORIZED ONLY FOR RESPONDING TO A REQUEST FOR QUOTATION OR FOR THE PERFORMANCE OF WORK FOR IBM. ALL QUESTIONS MUST BE REFERRED TO THE IBM PURCHASING DEPARTMENT.				LENOVO CONFIDENTIAL	



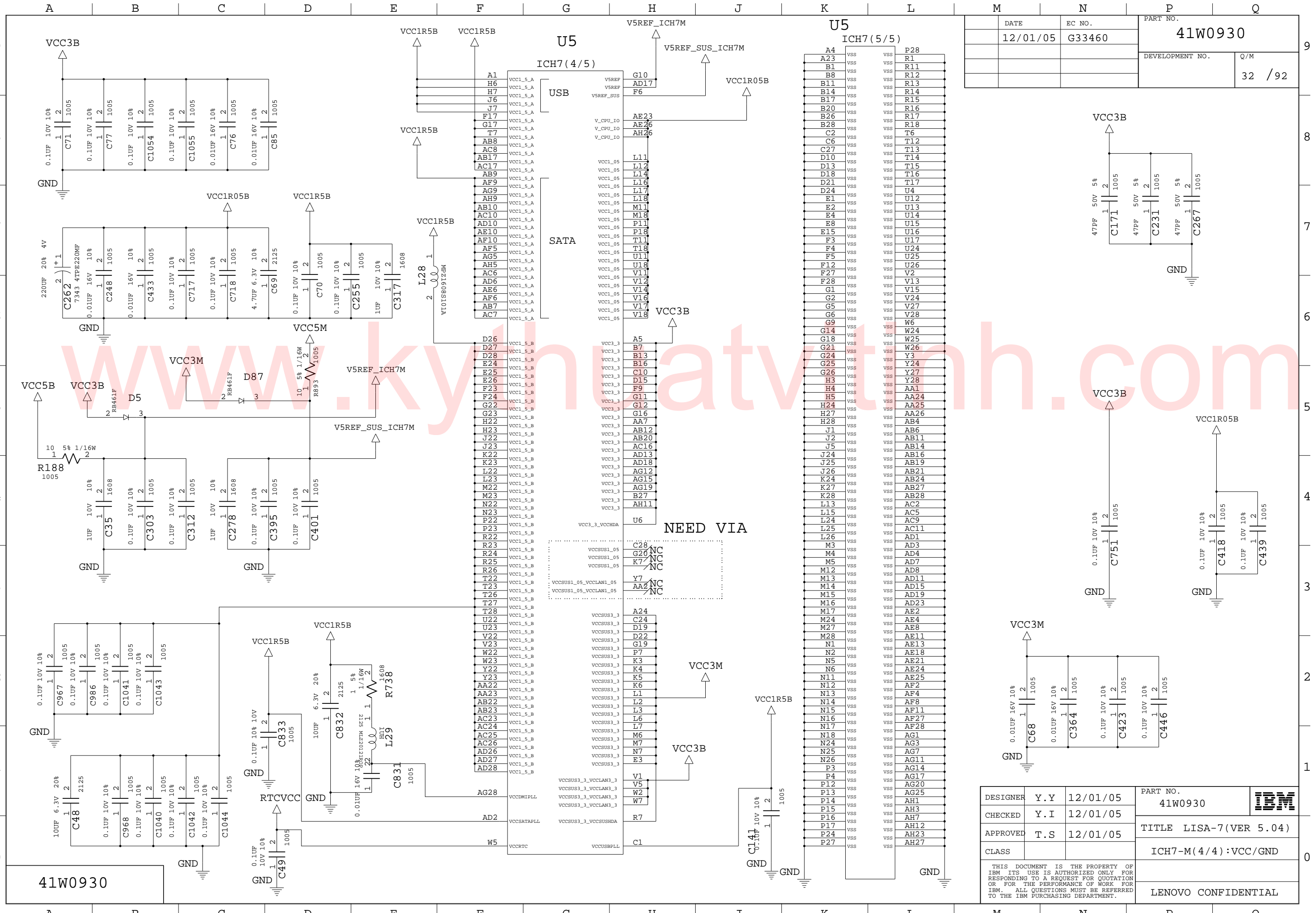

DATE	EC NO.	PART NO.
12/01/05	G33460	41W0930
DEVELOPMENT NO.		Q/M
		32 / 92

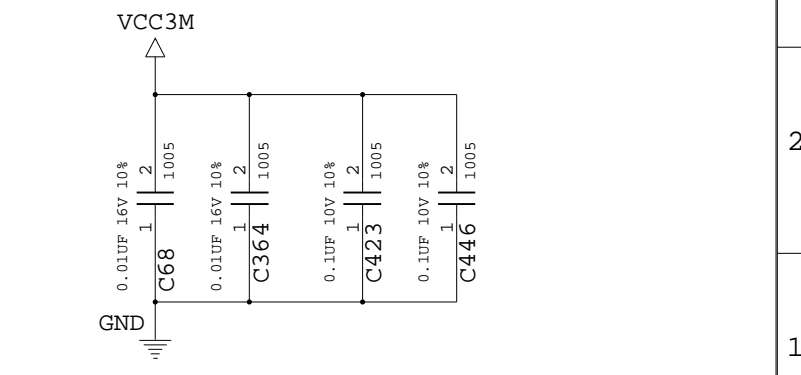
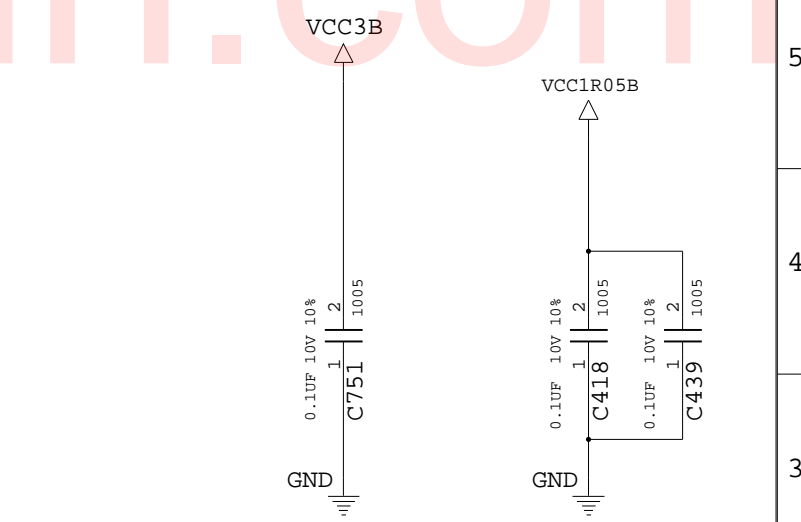
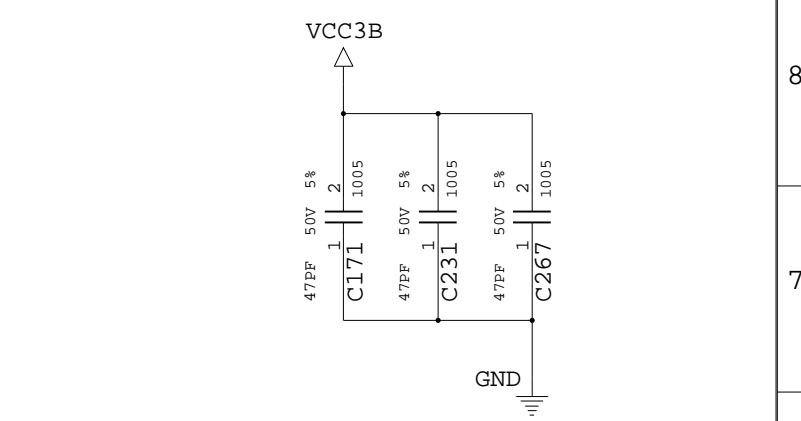

DESIGNER	Y.Y	12/01/05	PART NO.	41W0930	
CHECKED	Y.I	12/01/05	TITLE LISA-7(VER 5.04)		
APPROVED	T.S	12/01/05	CLASS ICH7-M(4/4):VCC/GND		
THIS DOCUMENT IS THE PROPERTY OF IBM ITS USE IS AUTHORIZED ONLY FOR RESPONDING TO A REQUEST FOR QUOTATION OR FOR THE PERFORMANCE OF WORK FOR IBM. ALL QUESTIONS MUST BE REFERRED TO THE IBM PURCHASING DEPARTMENT.					LENOVO CONFIDENTIAL

41W0930



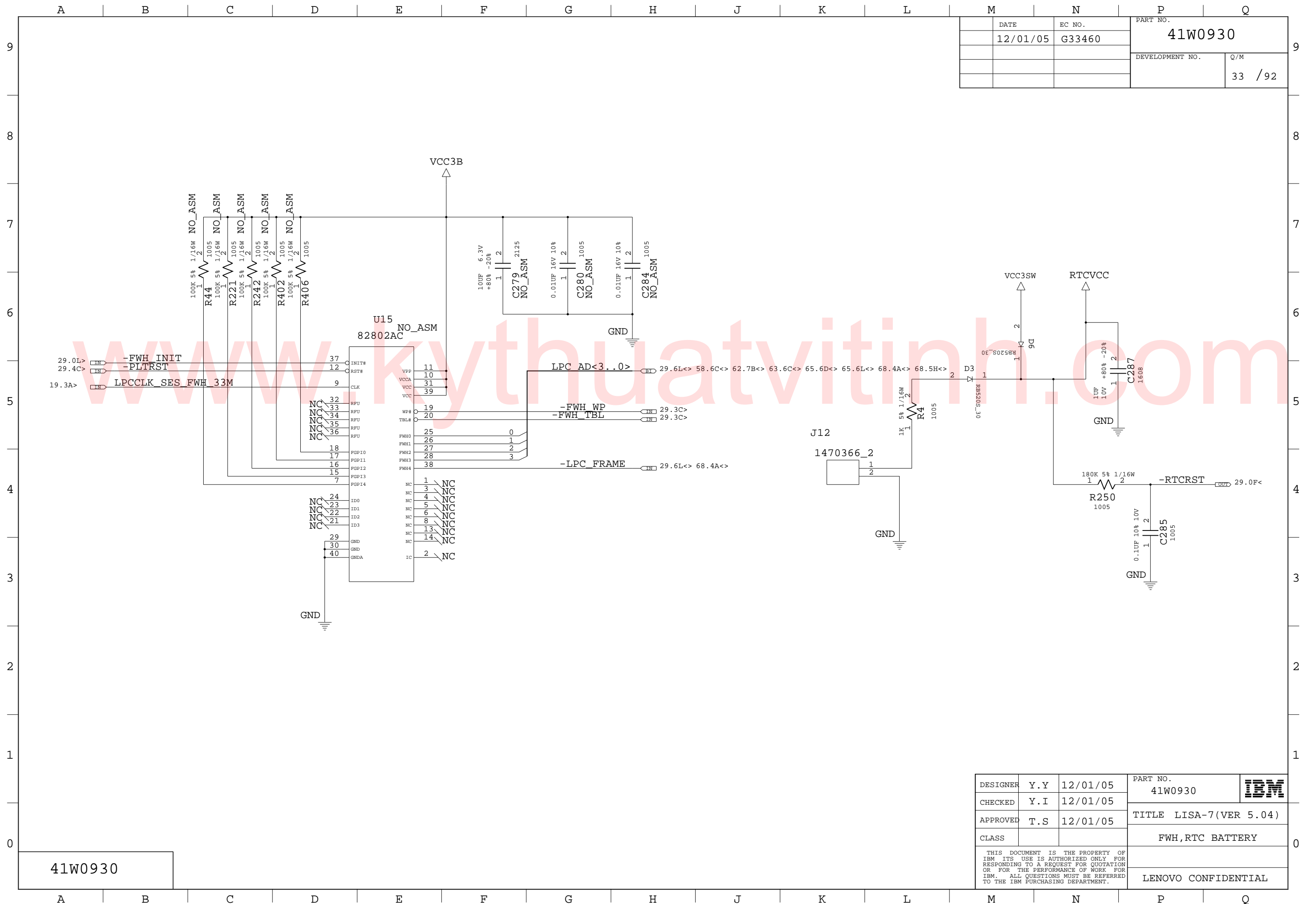

DATE	EC NO.	PART NO.	
12/01/05	G33460	41W0930	
		DEVELOPMENT NO.	Q/M
			33 / 92

41W0930

DESIGNER	Y.Y	12/01/05	PART NO.	41W0930	<b>IBM</b>
CHECKED	Y.I	12/01/05			
APPROVED	T.S	12/01/05	TITLE LISA-7(VER 5.04)		
CLASS			FWH, RTC BATTERY		
THIS DOCUMENT IS THE PROPERTY OF IBM ITS USE IS AUTHORIZED ONLY FOR RESPONDING TO A REQUEST FOR QUOTATION OR FOR THE PERFORMANCE OF WORK FOR IBM. ALL QUESTIONS MUST BE REFERRED TO THE IBM PURCHASING DEPARTMENT.				LENOVO CONFIDENTIAL	

	DATE	EC NO.	PART NO.	
	12/01/05	G33460	41W0930	
			DEVELOPMENT NO.	Q/M
				34 / 92

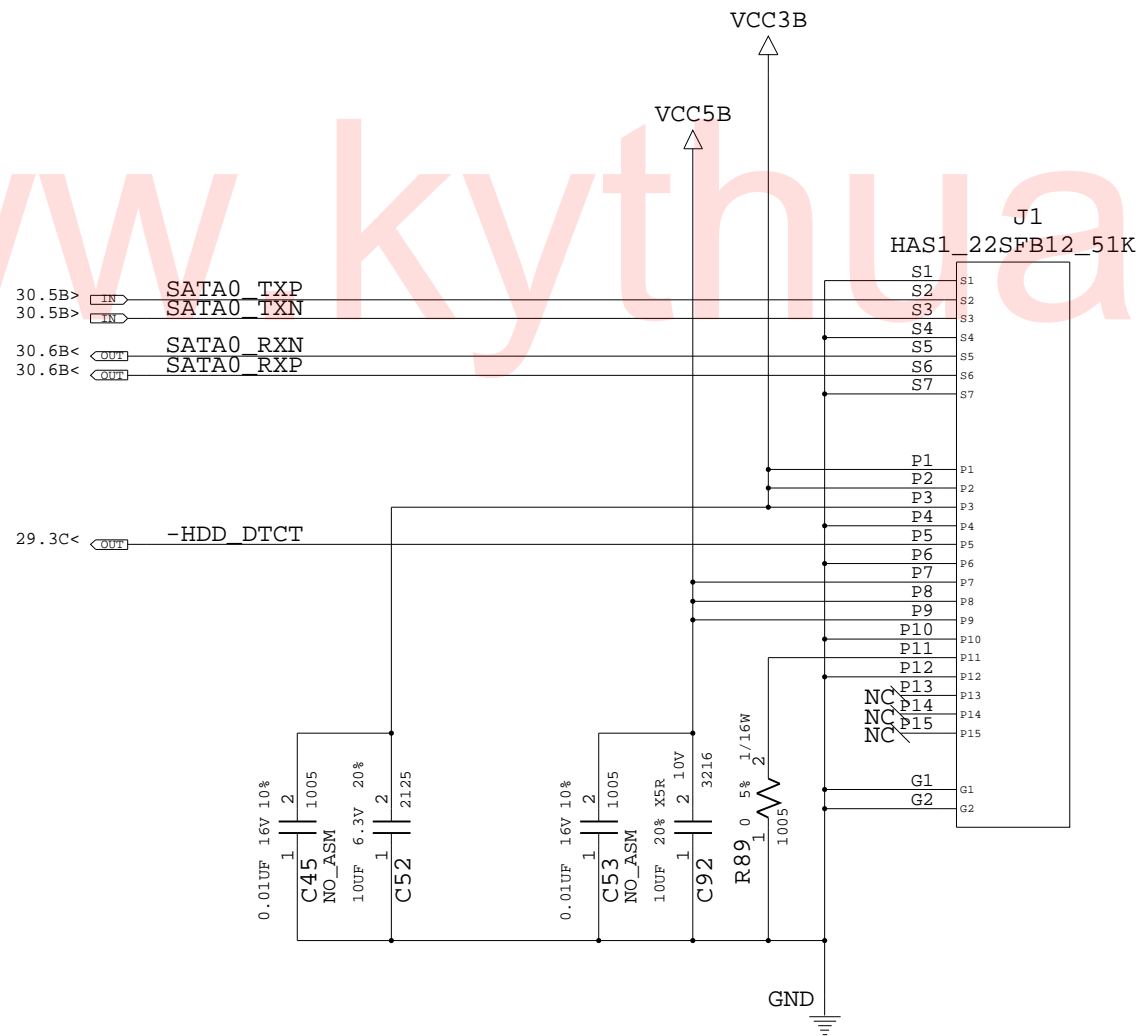

41W0930

DESIGNER	Y.Y	12/01/05	PART NO.	41W0930	<b>IBM</b>
CHECKED	Y.I	12/01/05			
APPROVED	T.S	12/01/05	TITLE LISA-7(VER 5.04)		
CLASS			SATA HDD CONN		
THIS DOCUMENT IS THE PROPERTY OF IBM ITS USE IS AUTHORIZED ONLY FOR RESPONDING TO A REQUEST FOR QUOTATION OR FOR THE PERFORMANCE OF WORK FOR IBM. ALL QUESTIONS MUST BE REFERRED TO THE IBM PURCHASING DEPARTMENT.				LENOVO CONFIDENTIAL	

DATE	12/01/05	EC NO.	G33460	PART NO.	41W0930
				DEVELOPMENT NO.	Q/M
				35 / 92	

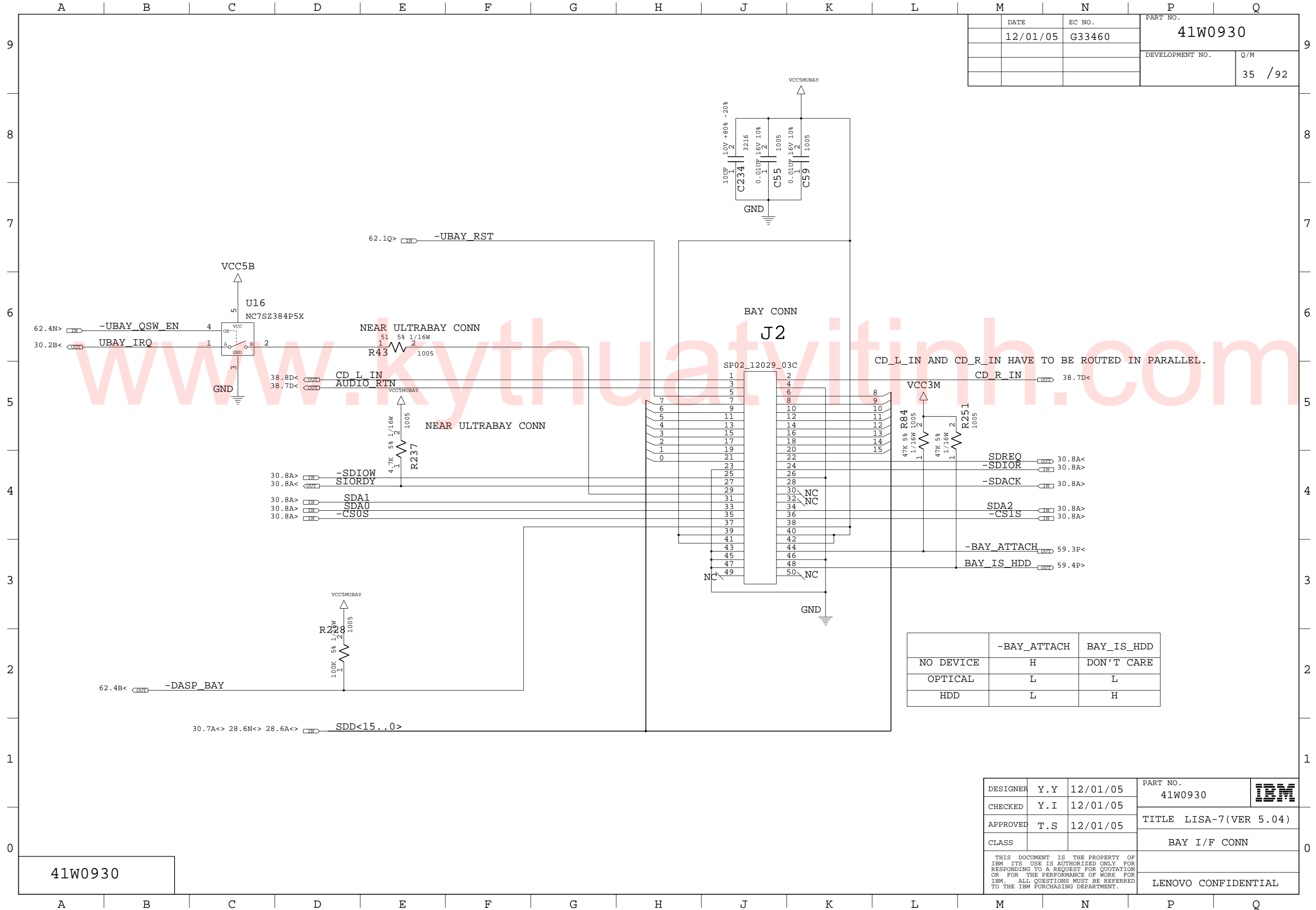

	-BAY_ATTACH	BAY_IS_HDD
NO DEVICE	H	DON'T CARE
OPTICAL	L	L
HDD	L	H

DESIGNER	Y.Y	12/01/05	PART NO.	41W0930	<b>IBM</b>
CHECKED	Y.I	12/01/05	TITLE LISA-7(VER 5.04)		
APPROVED	T.S	12/01/05	BAY I/F CONN		LENOVO CONFIDENTIAL
CLASS			THIS DOCUMENT IS THE PROPERTY OF IBM ITS USE IS AUTHORIZED ONLY FOR RESPONDING TO A REQUEST FOR QUOTATION OR FOR THE PERFORMANCE OF WORK FOR IBM. ALL QUESTIONS MUST BE REFERRED TO THE IBM PURCHASING DEPARTMENT.		

41W0930

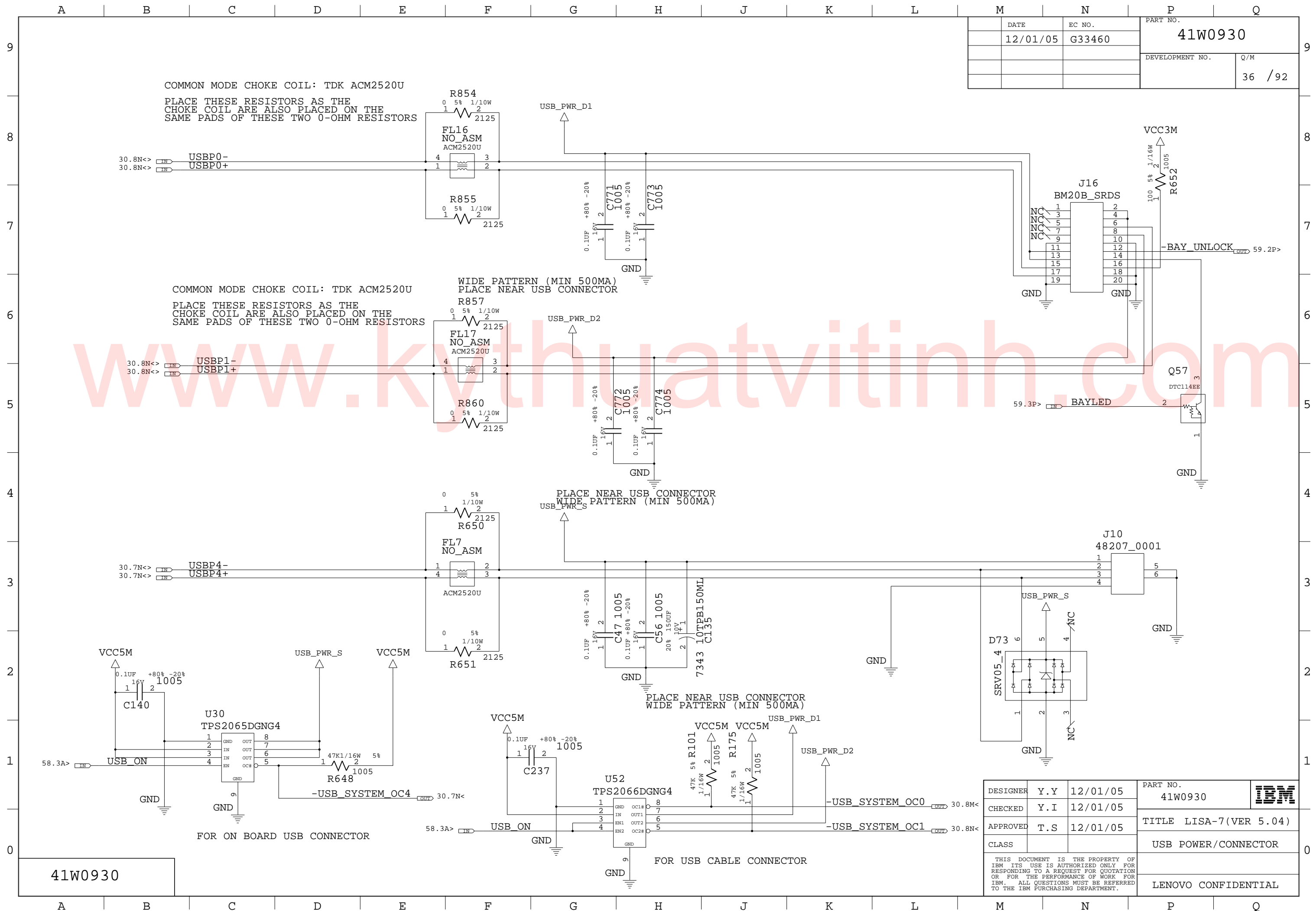

DATE	EC NO.	PART NO.
12/01/05	G33460	41W0930
DEVELOPMENT NO.		Q/M
		36 / 92

DESIGNER	Y.Y	12/01/05	PART NO.	41W0930	IBM
CHECKED	Y.I	12/01/05	TITLE LISA-7(VER 5.04)		
APPROVED	T.S	12/01/05	CLASS		USB POWER/CONNECTOR
THIS DOCUMENT IS THE PROPERTY OF IBM ITS USE IS AUTHORIZED ONLY FOR RESPONDING TO A REQUEST FOR QUOTATION OR FOR THE PERFORMANCE OF WORK FOR IBM. ALL QUESTIONS MUST BE REFERRED TO THE IBM PURCHASING DEPARTMENT.					LENOVO CONFIDENTIAL

41W0930

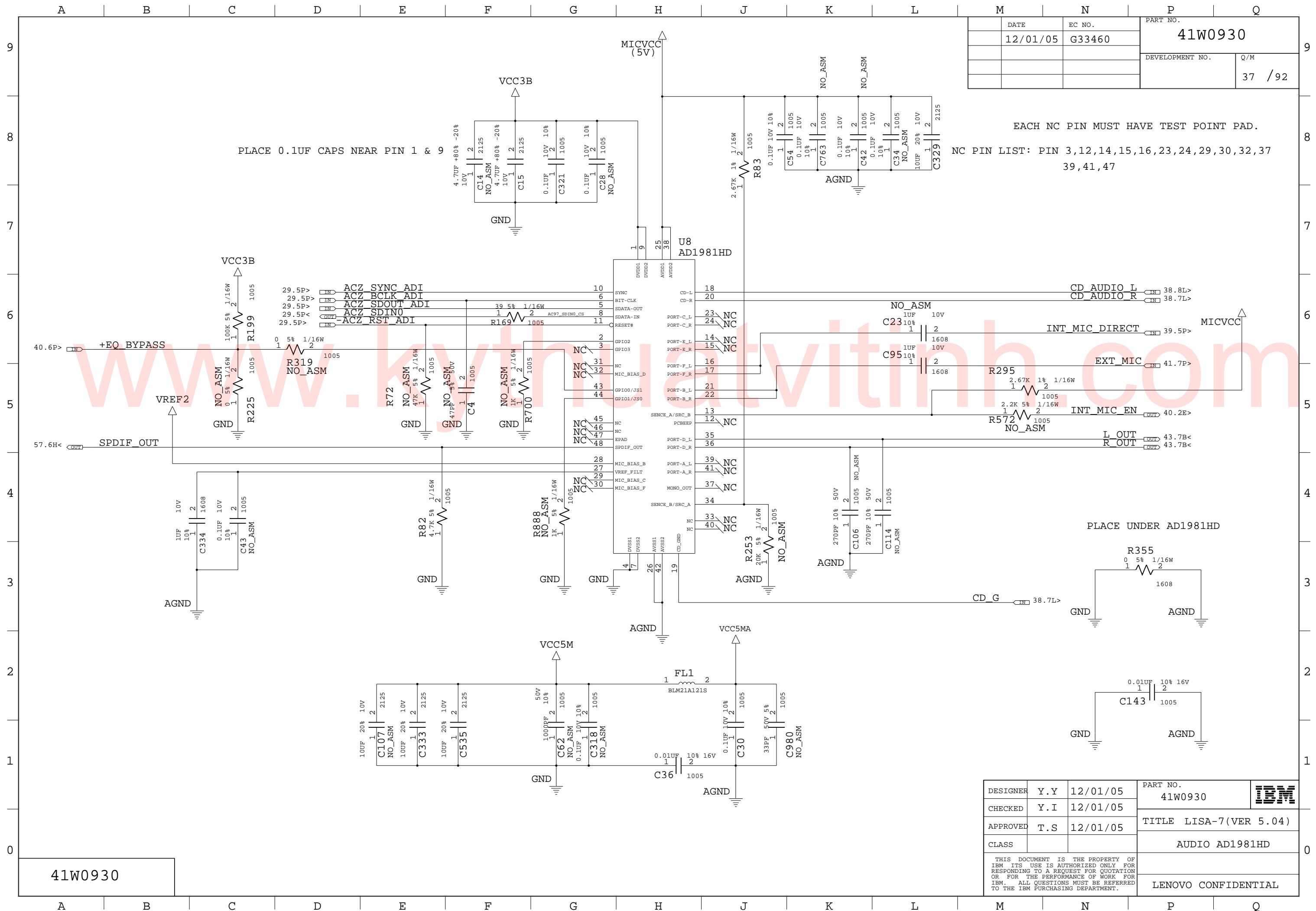

DATE	EC NO.	PART NO.
12/01/05	G33460	41W0930
		DEVELOPMENT NO.
		Q/M
		37 / 92

EACH NC PIN MUST HAVE TEST POINT PAD.  
 NC PIN LIST: PIN 3,12,14,15,16,23,24,29,30,32,37  
 39,41,47

DESIGNER	Y.Y	12/01/05	PART NO.	41W0930	
CHECKED	Y.I	12/01/05	TITLE LISA-7(VER 5.04)		
APPROVED	T.S	12/01/05	AUDIO AD1981HD		
CLASS			LENVO CONFIDENTIAL		

THIS DOCUMENT IS THE PROPERTY OF IBM ITS USE IS AUTHORIZED ONLY FOR RESPONDING TO A REQUEST FOR QUOTATION OR FOR THE PERFORMANCE OF WORK FOR IBM. ALL QUESTIONS MUST BE REFERRED TO THE IBM PURCHASING DEPARTMENT.

41W0930

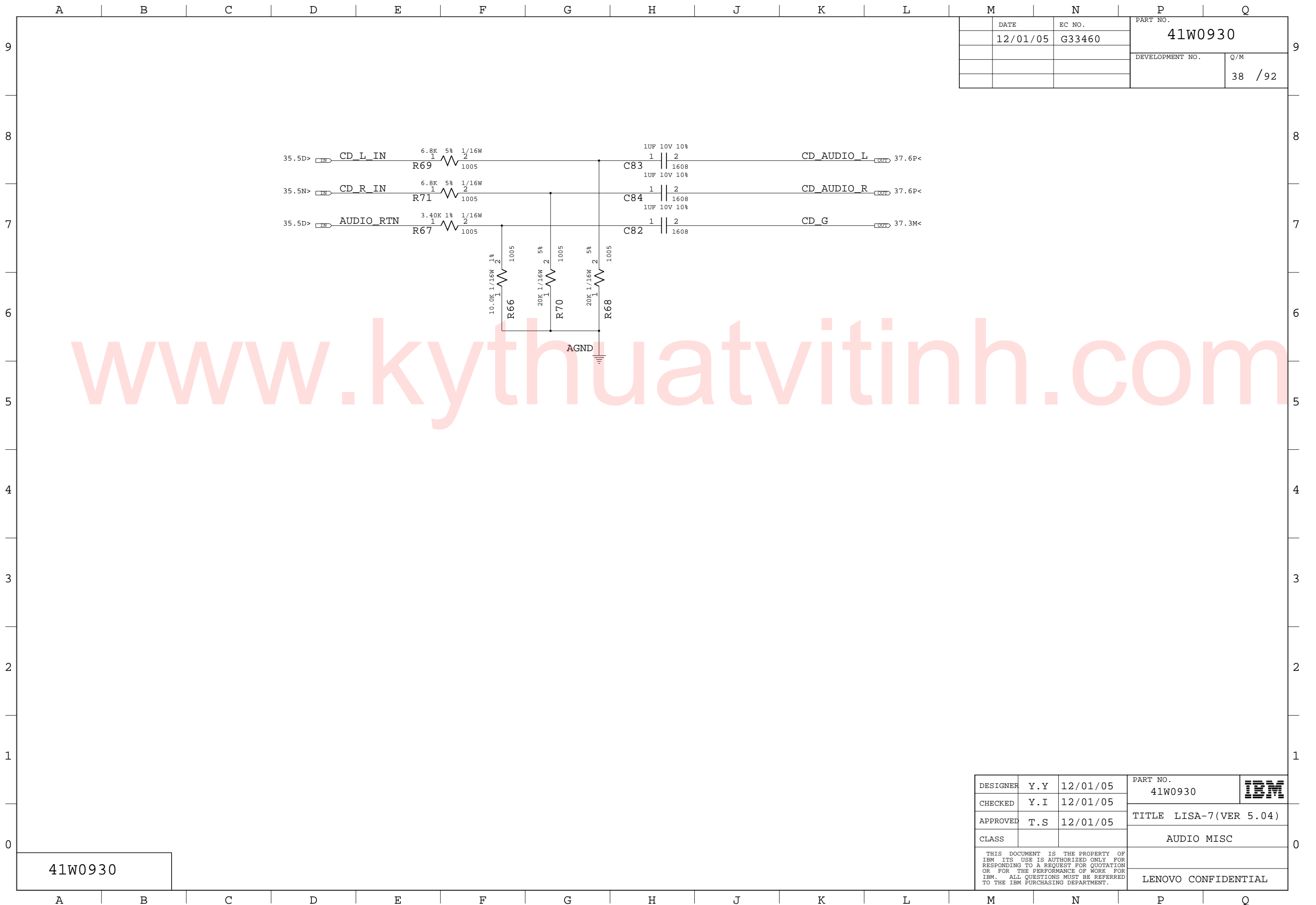

DATE	EC NO.	PART NO.	
12/01/05	G33460	41W0930	
		DEVELOPMENT NO.	Q/M
			38 / 92

www.kythuatvithinh.com

41W0930

DESIGNER	Y.Y	12/01/05	PART NO.	41W0930	<b>IBM</b>
CHECKED	Y.I	12/01/05			
APPROVED	T.S	12/01/05	TITLE LISA-7(VER 5.04)		
CLASS			AUDIO MISC		
THIS DOCUMENT IS THE PROPERTY OF IBM ITS USE IS AUTHORIZED ONLY FOR RESPONDING TO A REQUEST FOR QUOTATION OR FOR THE PERFORMANCE OF WORK FOR IBM. ALL QUESTIONS MUST BE REFERRED TO THE IBM PURCHASING DEPARTMENT.				LENOVO CONFIDENTIAL	

DATE	EC NO.	PART NO.
12/01/05	G33460	41W0930
DEVELOPMENT NO.		Q/M
		39 / 92

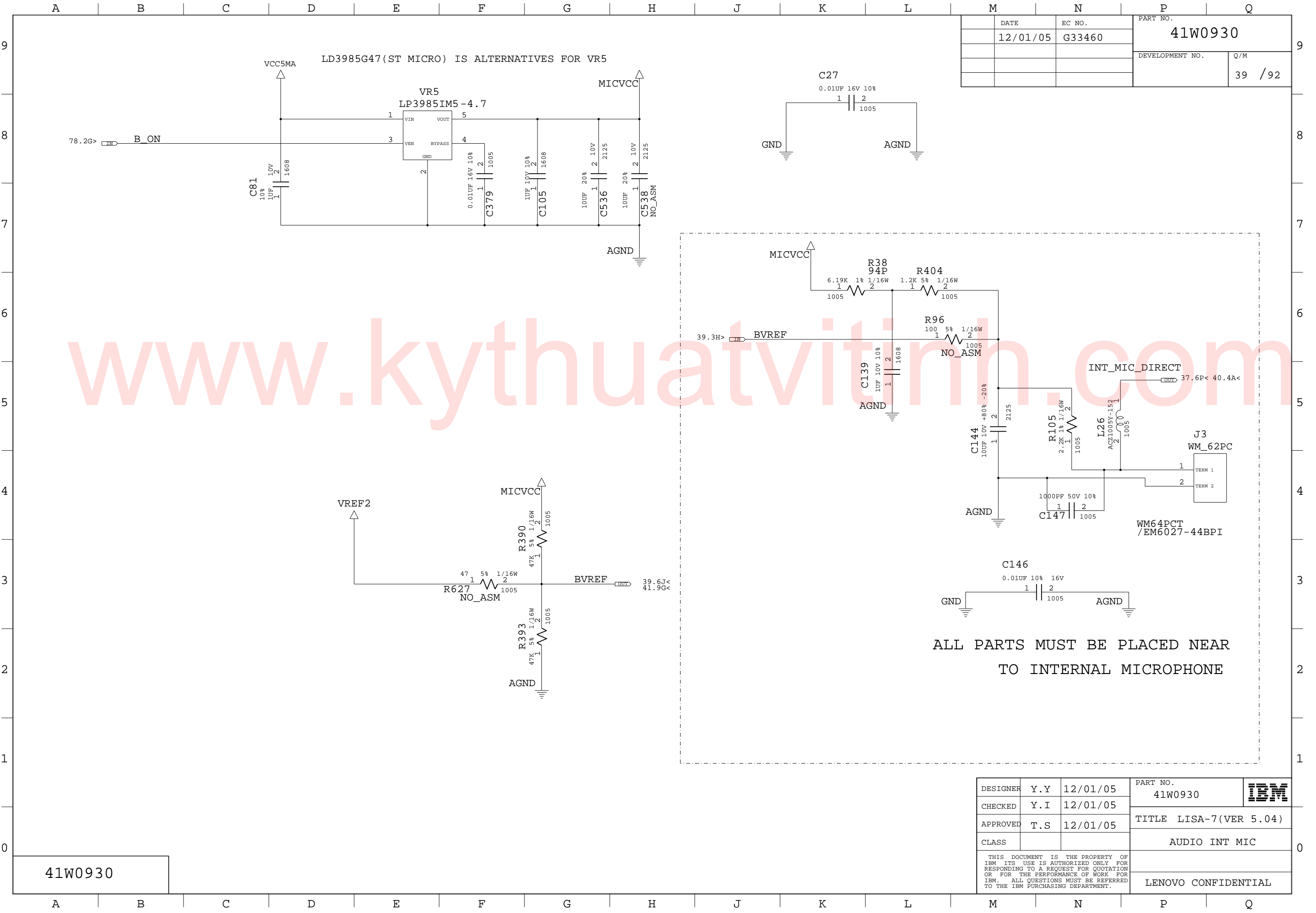

41W0930

DESIGNER	Y.Y	12/01/05	PART NO.	41W0930	
CHECKED	Y.I	12/01/05	TITLE LISA-7(VER 5.04)		
APPROVED	T.S	12/01/05	AUDIO INT MIC		LENOVO CONFIDENTIAL
CLASS			THIS DOCUMENT IS THE PROPERTY OF IBM ITS USE IS AUTHORIZED ONLY FOR RESPONDING TO A REQUEST FOR QUOTATION OR FOR THE PERFORMANCE OF WORK FOR IBM. ALL QUESTIONS MUST BE REFERRED TO THE IBM PURCHASING DEPARTMENT.		

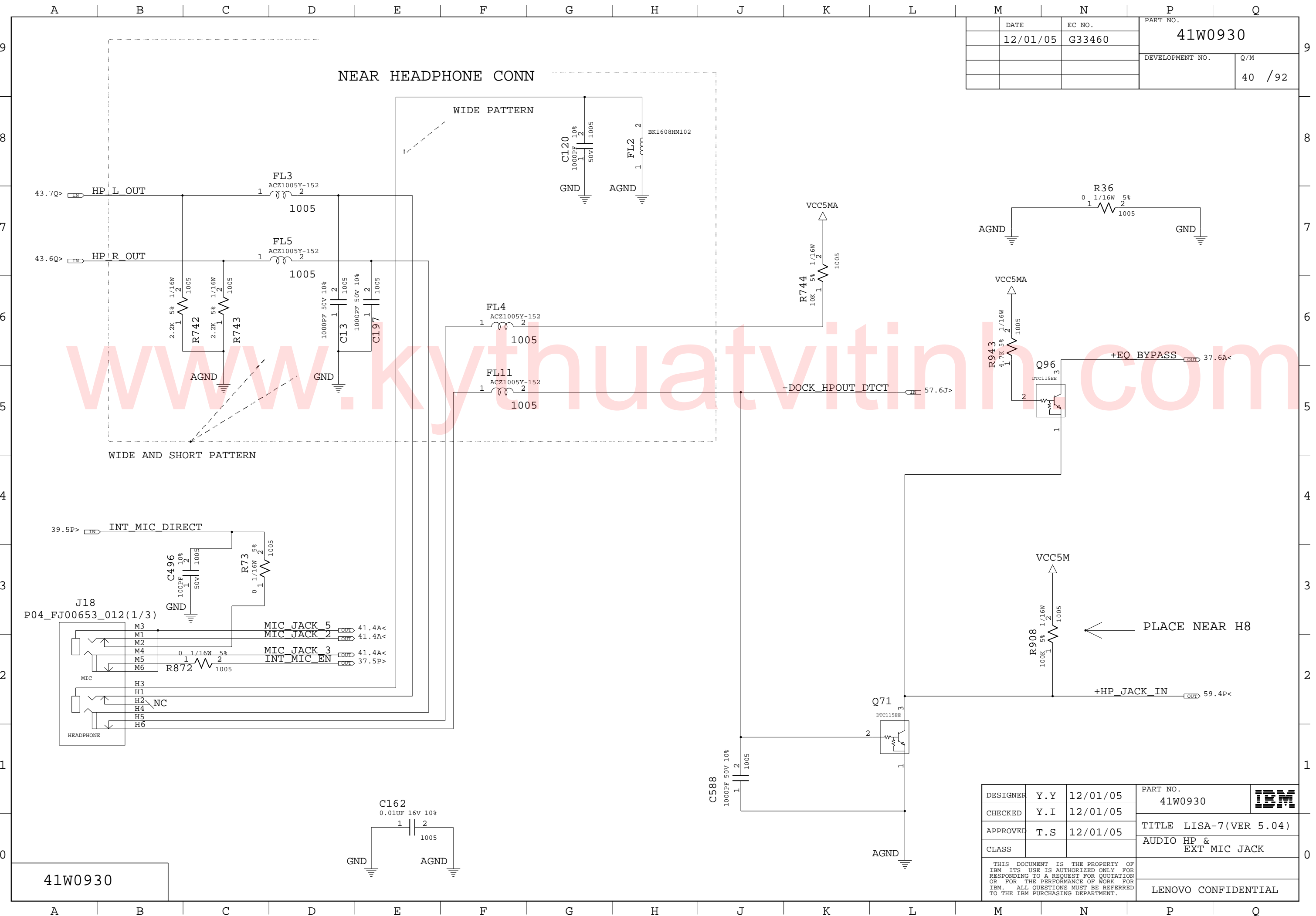

DATE	EC NO.	PART NO.	
12/01/05	G33460	41W0930	
		DEVELOPMENT NO.	Q/M
			40 / 92

41W0930

DESIGNER	Y.Y	12/01/05	PART NO.	41W0930	IBM
CHECKED	Y.I	12/01/05			
APPROVED	T.S	12/01/05	TITLE	LISA-7(VER 5.04)	
CLASS			AUDIO HP & EXT MIC JACK		
THIS DOCUMENT IS THE PROPERTY OF IBM. ITS USE IS AUTHORIZED ONLY FOR RESPONDING TO A REQUEST FOR QUOTATION OR FOR THE PERFORMANCE OF WORK FOR IBM. ALL QUESTIONS MUST BE REFERRED TO THE IBM PURCHASING DEPARTMENT.					LENOVO CONFIDENTIAL





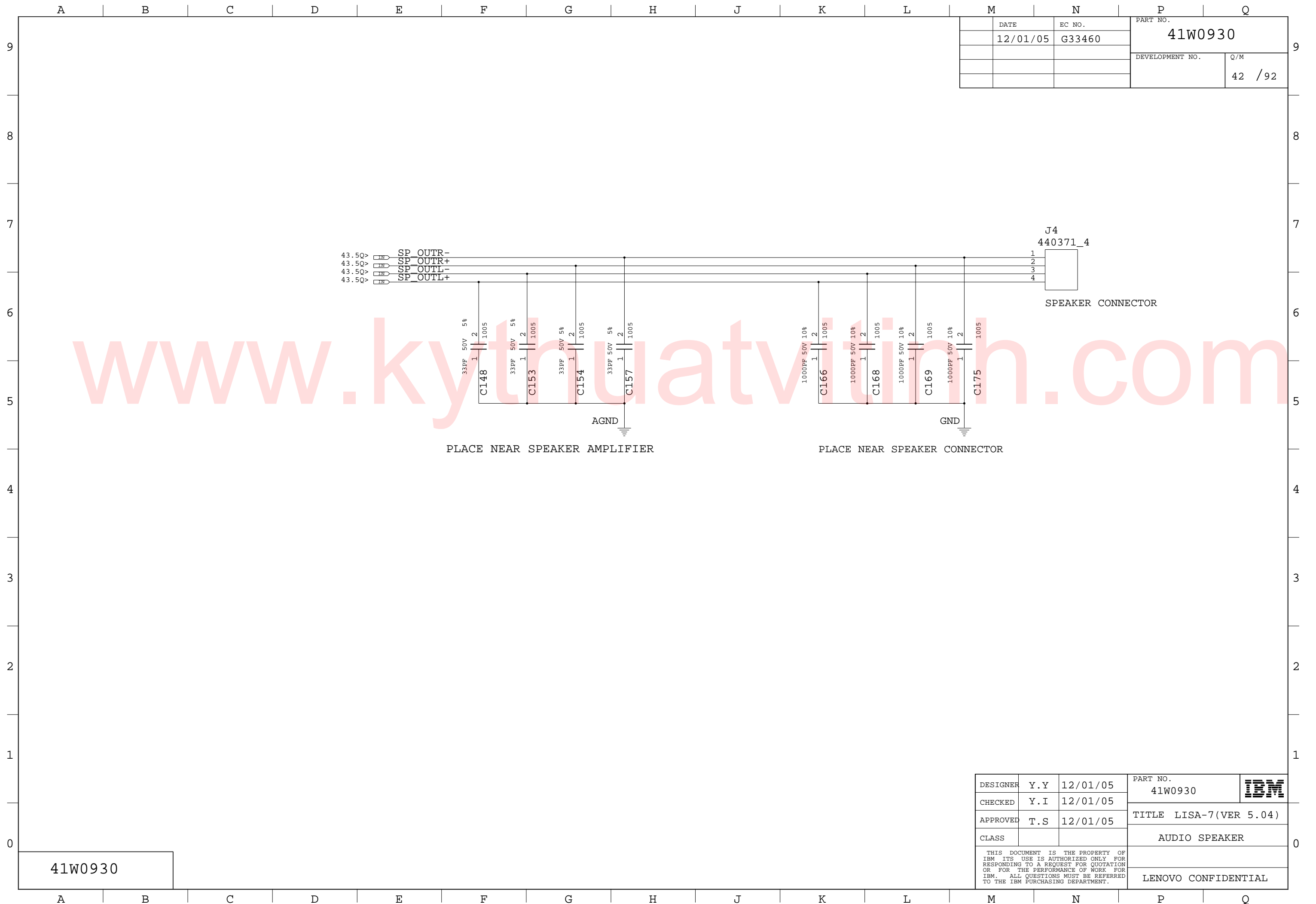

DATE	EC NO.	PART NO.	
12/01/05	G33460	41W0930	
		DEVELOPMENT NO.	Q/M
			42 /92

41W0930

DESIGNER	Y.Y	12/01/05	PART NO.	41W0930	<b>IBM</b>
CHECKED	Y.I	12/01/05			
APPROVED	T.S	12/01/05	TITLE LISA-7(VER 5.04)		
CLASS			AUDIO SPEAKER		
THIS DOCUMENT IS THE PROPERTY OF IBM ITS USE IS AUTHORIZED ONLY FOR RESPONDING TO A REQUEST FOR QUOTATION OR FOR THE PERFORMANCE OF WORK FOR IBM. ALL QUESTIONS MUST BE REFERRED TO THE IBM PURCHASING DEPARTMENT.				LENOVO CONFIDENTIAL	

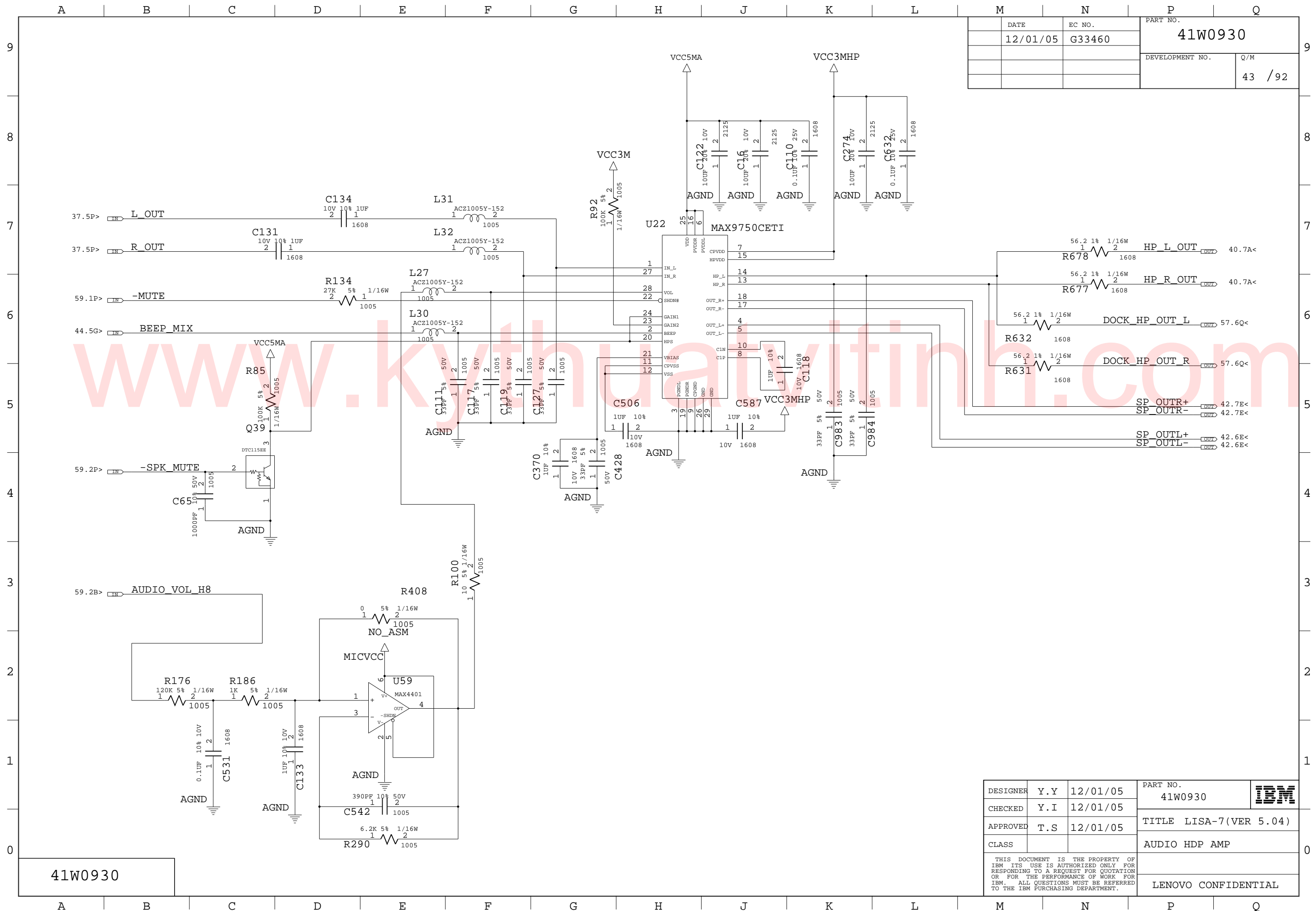

DATE	EC NO.	PART NO.	
12/01/05	G33460	41W0930	
		DEVELOPMENT NO.	Q/M
			43 / 92

41W0930

DESIGNER	Y.Y	12/01/05	PART NO.	41W0930	
CHECKED	Y.I	12/01/05	TITLE		
APPROVED	T.S	12/01/05	CLASS	AUDIO HDP AMP	
THIS DOCUMENT IS THE PROPERTY OF IBM ITS USE IS AUTHORIZED ONLY FOR RESPONDING TO A REQUEST FOR QUOTATION OR FOR THE PERFORMANCE OF WORK FOR IBM. ALL QUESTIONS MUST BE REFERRED TO THE IBM PURCHASING DEPARTMENT.					LENOVO CONFIDENTIAL

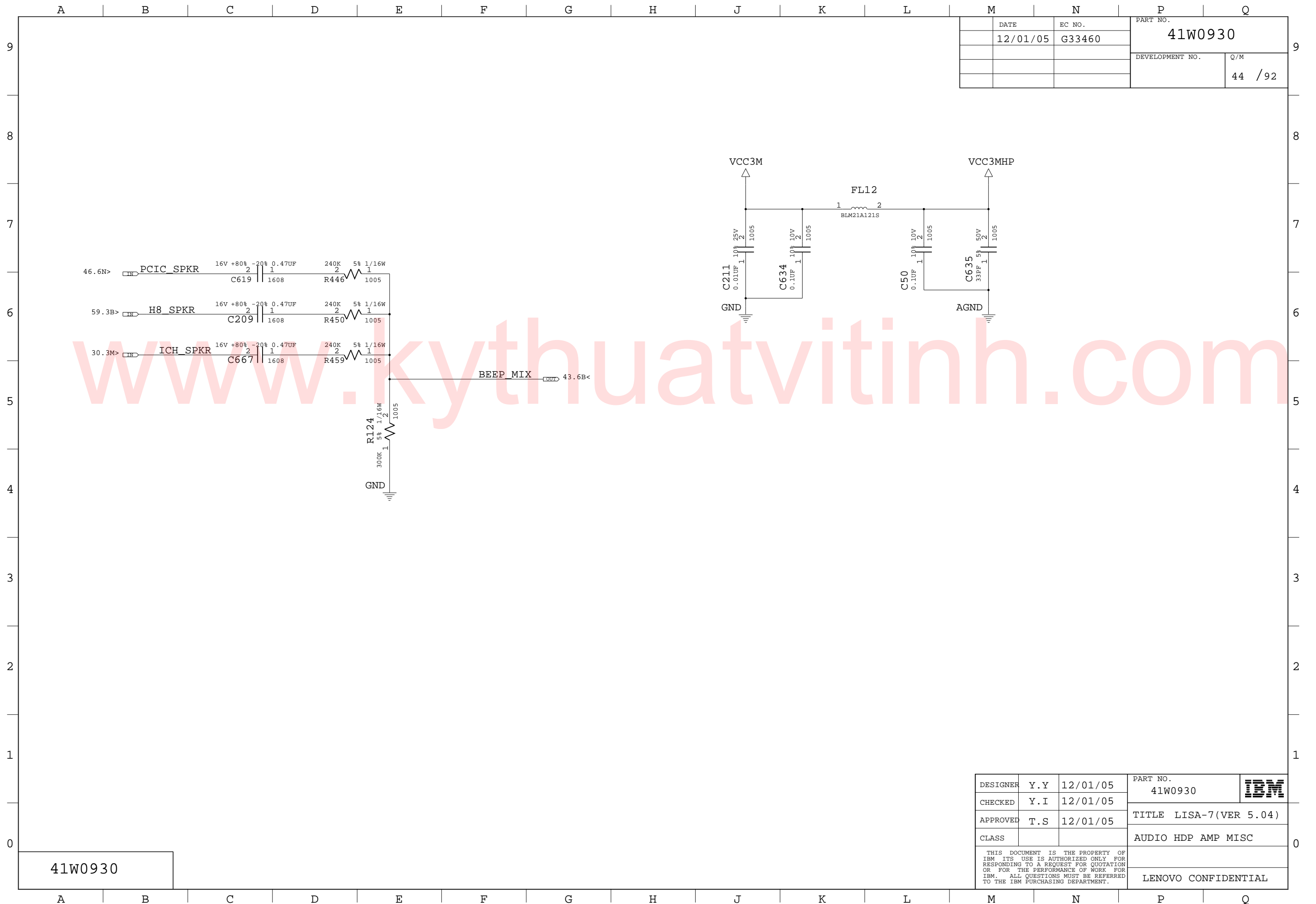

DATE	12/01/05	EC NO.	G33460	PART NO.	41W0930
				DEVELOPMENT NO.	44 / 92
				Q/M	

41W0930

DESIGNER	Y.Y	12/01/05	PART NO.	41W0930	<b>IBM</b>
CHECKED	Y.I	12/01/05	TITLE LISA-7(VER 5.04)		
APPROVED	T.S	12/01/05	CLASS AUDIO HDP AMP MISC		
THIS DOCUMENT IS THE PROPERTY OF IBM ITS USE IS AUTHORIZED ONLY FOR RESPONDING TO A REQUEST FOR QUOTATION OR FOR THE PERFORMANCE OF WORK FOR IBM. ALL QUESTIONS MUST BE REFERRED TO THE IBM PURCHASING DEPARTMENT.				LENOVO CONFIDENTIAL	

	DATE	EC NO.	PART NO.	
	12/01/05	G33460	41W0930	
			DEVELOPMENT NO.	Q/M
				45 / 92

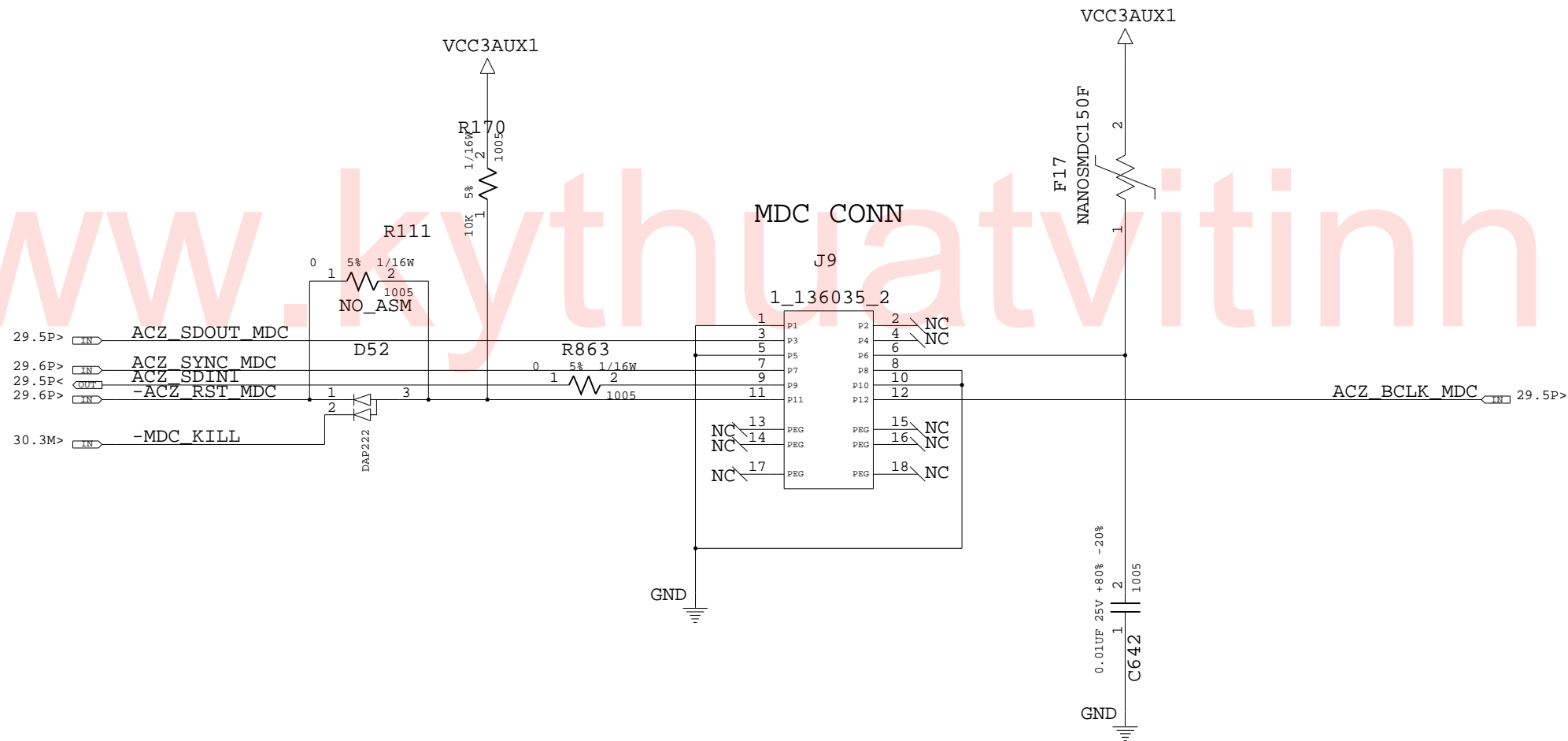

41W0930

DESIGNER	Y.Y	12/01/05	PART NO.	41W0930	<b>IBM</b>
CHECKED	Y.I	12/01/05			
APPROVED	T.S	12/01/05	TITLE LISA-7(VER 5.04)		
CLASS			MDC 1.5 CONNECTOR		
THIS DOCUMENT IS THE PROPERTY OF IBM ITS USE IS AUTHORIZED ONLY FOR RESPONDING TO A REQUEST FOR QUOTATION OR FOR THE PERFORMANCE OF WORK FOR IBM. ALL QUESTIONS MUST BE REFERRED TO THE IBM PURCHASING DEPARTMENT.				LENOVO CONFIDENTIAL	

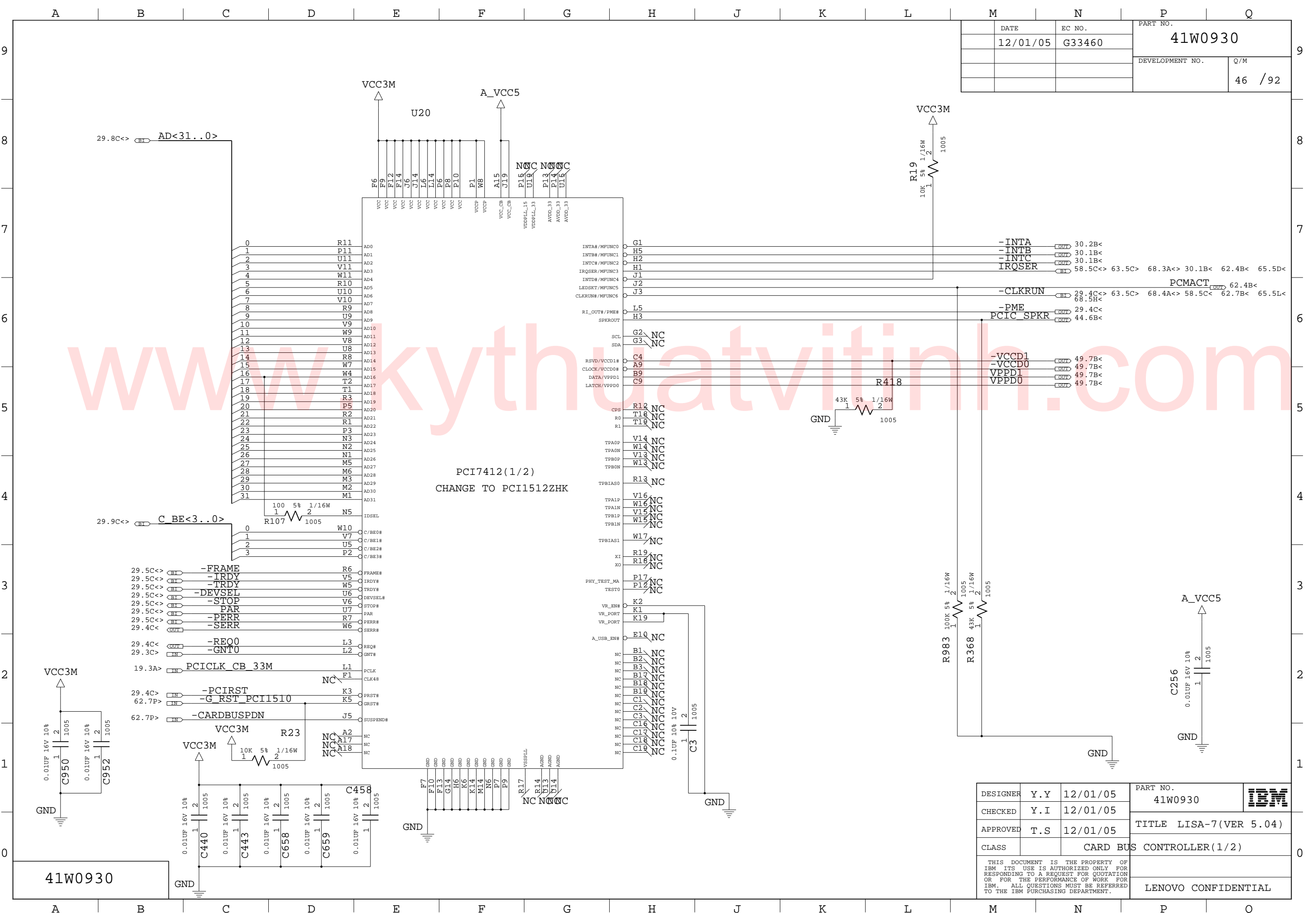

DATE	EC NO.	PART NO.	
12/01/05	G33460	41W0930	
		DEVELOPMENT NO.	Q/M
			46 / 92

PCI7412(1/2)  
CHANGE TO PCI1512ZHK

41W0930

DESIGNER	Y.Y	12/01/05	PART NO.	41W0930	IBM
CHECKED	Y.I	12/01/05			
APPROVED	T.S	12/01/05	TITLE LISA-7(VER 5.04)		
CLASS		CARD BUS	CONTROLLER(1/2)		
THIS DOCUMENT IS THE PROPERTY OF IBM. ITS USE IS AUTHORIZED ONLY FOR RESPONDING TO A REQUEST FOR QUOTATION OR FOR THE PERFORMANCE OF WORK FOR IBM. ALL QUESTIONS MUST BE REFERRED TO THE IBM PURCHASING DEPARTMENT.					LENOVO CONFIDENTIAL





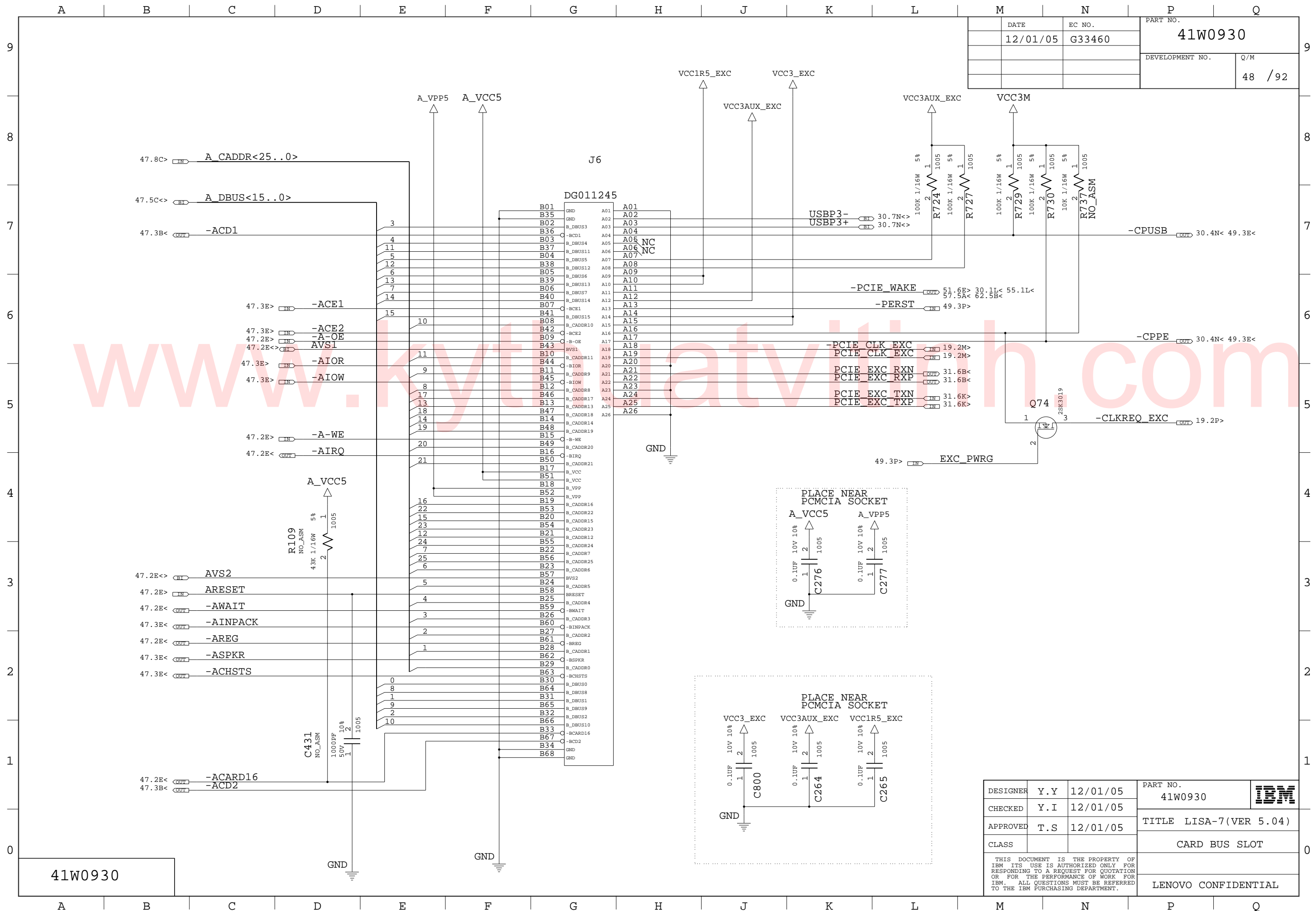

DATE	EC NO.	PART NO.
12/01/05	G33460	41W0930
DEVELOPMENT NO.		Q/M
		48 / 92

DESIGNER	Y.Y	12/01/05	PART NO.	41W0930	
CHECKED	Y.I	12/01/05	TITLE		
APPROVED	T.S	12/01/05	CARD BUS SLOT		
CLASS					
THIS DOCUMENT IS THE PROPERTY OF IBM. ITS USE IS AUTHORIZED ONLY FOR RESPONDING TO A REQUEST FOR QUOTATION OR FOR THE PERFORMANCE OF WORK FOR IBM. ALL QUESTIONS MUST BE REFERRED TO THE IBM PURCHASING DEPARTMENT.					LENOVO CONFIDENTIAL

41W0930

DATE	EC NO.	PART NO.	
12/01/05	G33460	41W0930	
		DEVELOPMENT NO.	Q/M
			49 / 92

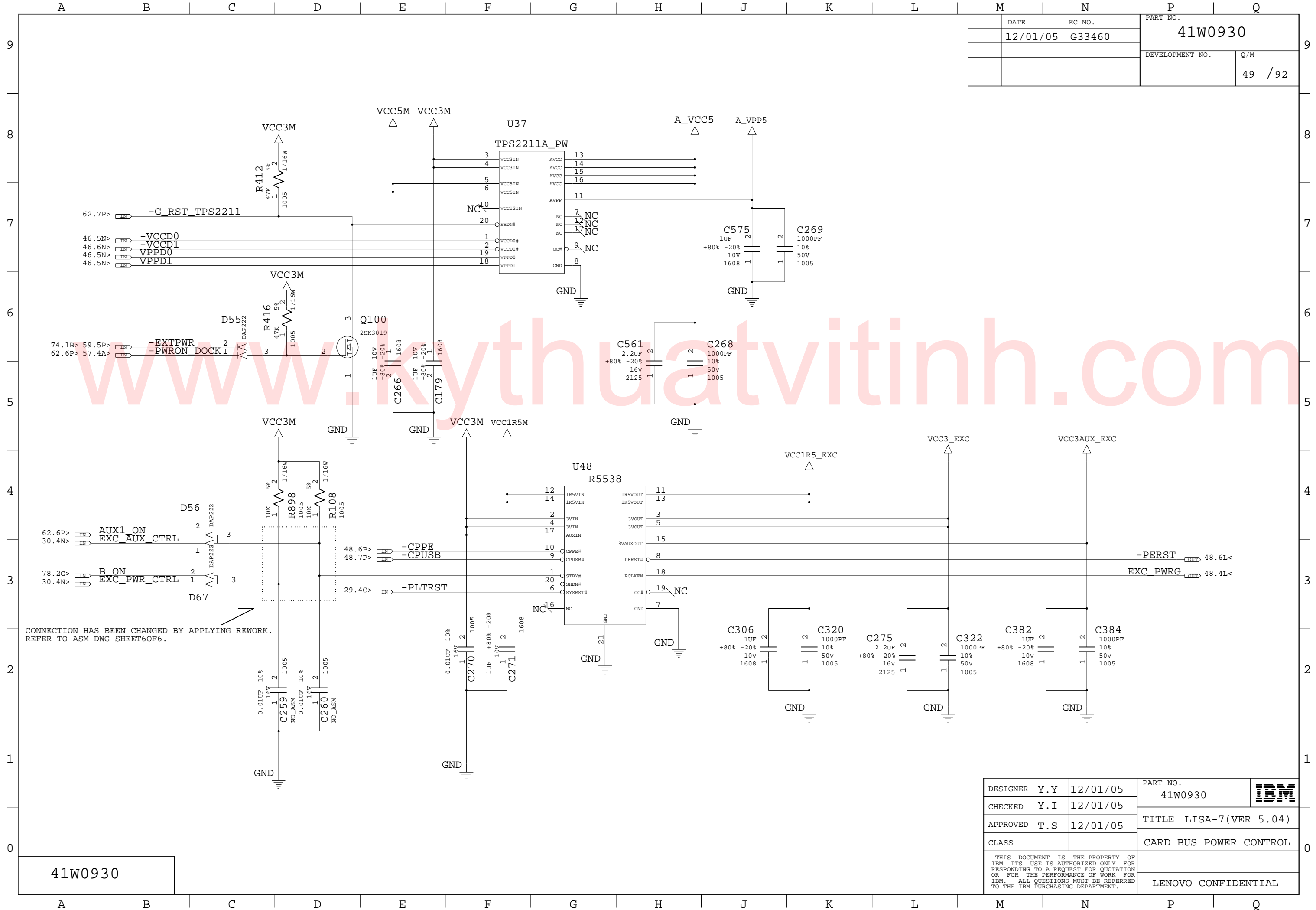

41W0930

DESIGNER	Y.Y	12/01/05	PART NO.	41W0930	
CHECKED	Y.I	12/01/05			
APPROVED	T.S	12/01/05	TITLE LISA-7(VER 5.04)		
CLASS			CARD BUS POWER CONTROL		
THIS DOCUMENT IS THE PROPERTY OF IBM ITS USE IS AUTHORIZED ONLY FOR RESPONDING TO A REQUEST FOR QUOTATION OR FOR THE PERFORMANCE OF WORK FOR IBM. ALL QUESTIONS MUST BE REFERRED TO THE IBM PURCHASING DEPARTMENT.					LENOVO CONFIDENTIAL

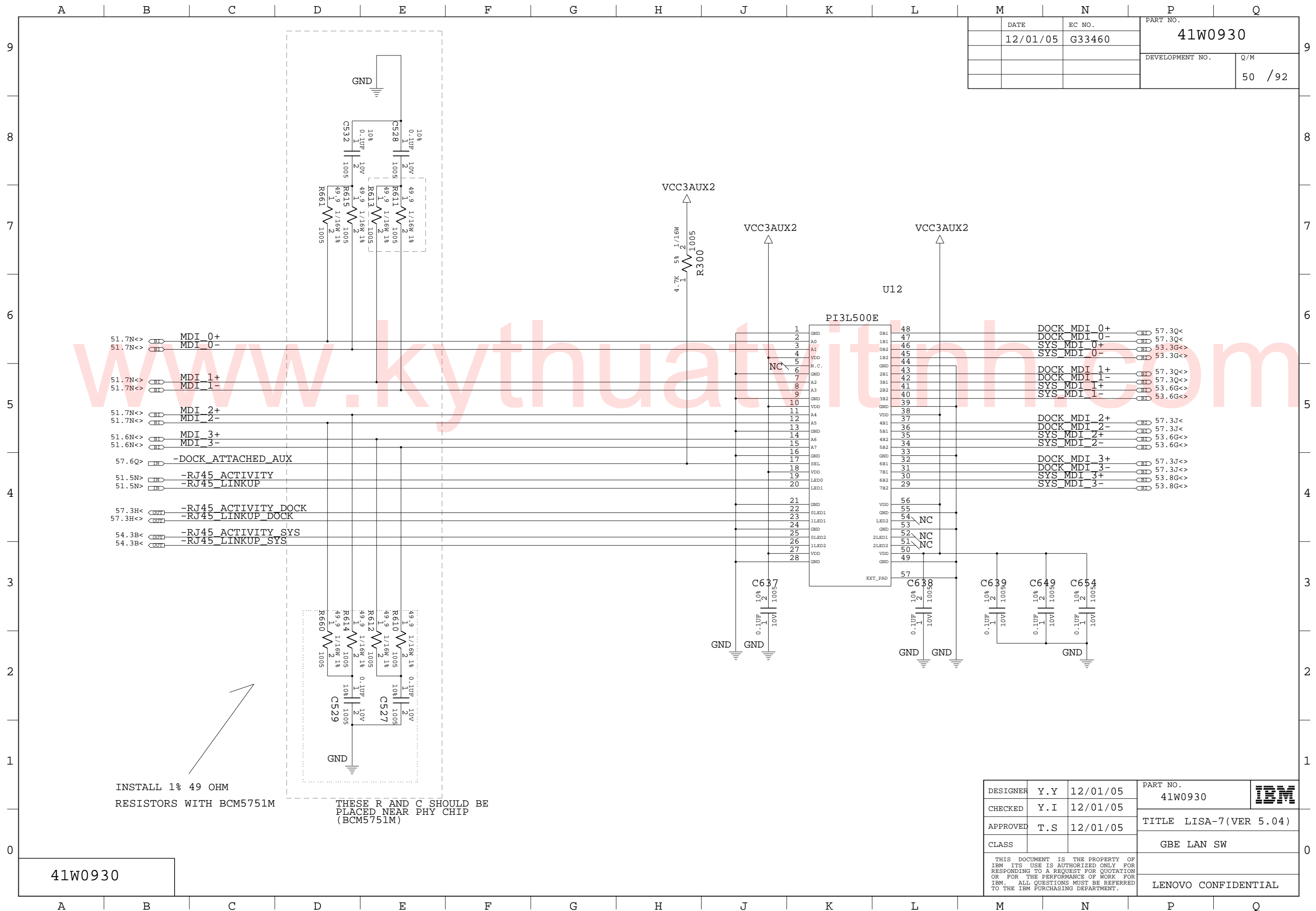

DATE	EC NO.	PART NO.	
12/01/05	G33460	41W0930	
		DEVELOPMENT NO.	Q/M
			50 / 92

DESIGNER	Y.Y	12/01/05	PART NO.	41W0930	
CHECKED	Y.I	12/01/05			
APPROVED	T.S	12/01/05	TITLE LISA-7(VER 5.04)		
CLASS			GBE LAN SW		
THIS DOCUMENT IS THE PROPERTY OF IBM ITS USE IS AUTHORIZED ONLY FOR RESPONDING TO A REQUEST FOR QUOTATION OR FOR THE PERFORMANCE OF WORK FOR IBM. ALL QUESTIONS MUST BE REFERRED TO THE IBM PURCHASING DEPARTMENT.					LENOVO CONFIDENTIAL

41W0930

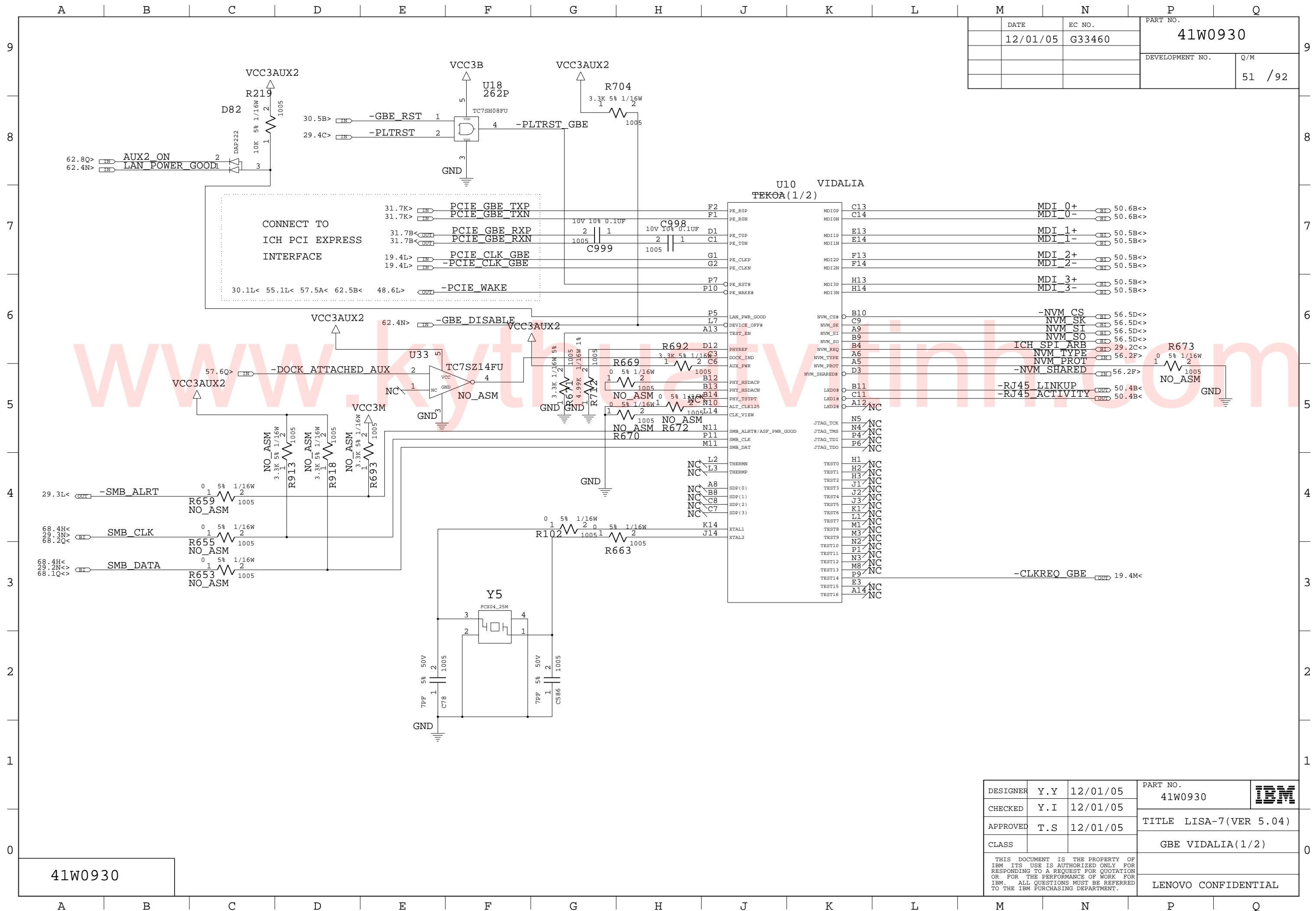

DATE	12/01/05	EC NO.	G33460	PART NO.	41W0930
				DEVELOPMENT NO.	Q/M
					51 / 92

41W0930

DESIGNER	Y.Y	12/01/05	PART NO.	41W0930	
CHECKED	Y.I	12/01/05	TITLE LISA-7(VER 5.04)		
APPROVED	T.S	12/01/05	TITLE LISA-7(VER 5.04)		
CLASS			GBE VIDALIA(1/2)		
THIS DOCUMENT IS THE PROPERTY OF IBM ITS USE IS AUTHORIZED ONLY FOR RESPONDING TO A REQUEST FOR QUOTATION OR FOR THE PERFORMANCE OF WORK FOR IBM. ALL QUESTIONS MUST BE REFERRED TO THE IBM PURCHASING DEPARTMENT.					LENOVO CONFIDENTIAL

DATE	EC NO.	PART NO.
12/01/05	G33460	41W0930
DEVELOPMENT NO.		Q/M
		52 / 92

**VCC3.3 SUPPLY NOTE:**  
 IF ALERTING OR WOL IS SUPPORTED, VCC3AUX MUST BE SOURCED FROM EITHER PCI\_AUX 3.3V OR THE PLANAR 3.3V STBY. OTHERWISE VCC3.3 CAN BE SOURCED FROM A NON-STANDBY 3.3V POWER RAIL.

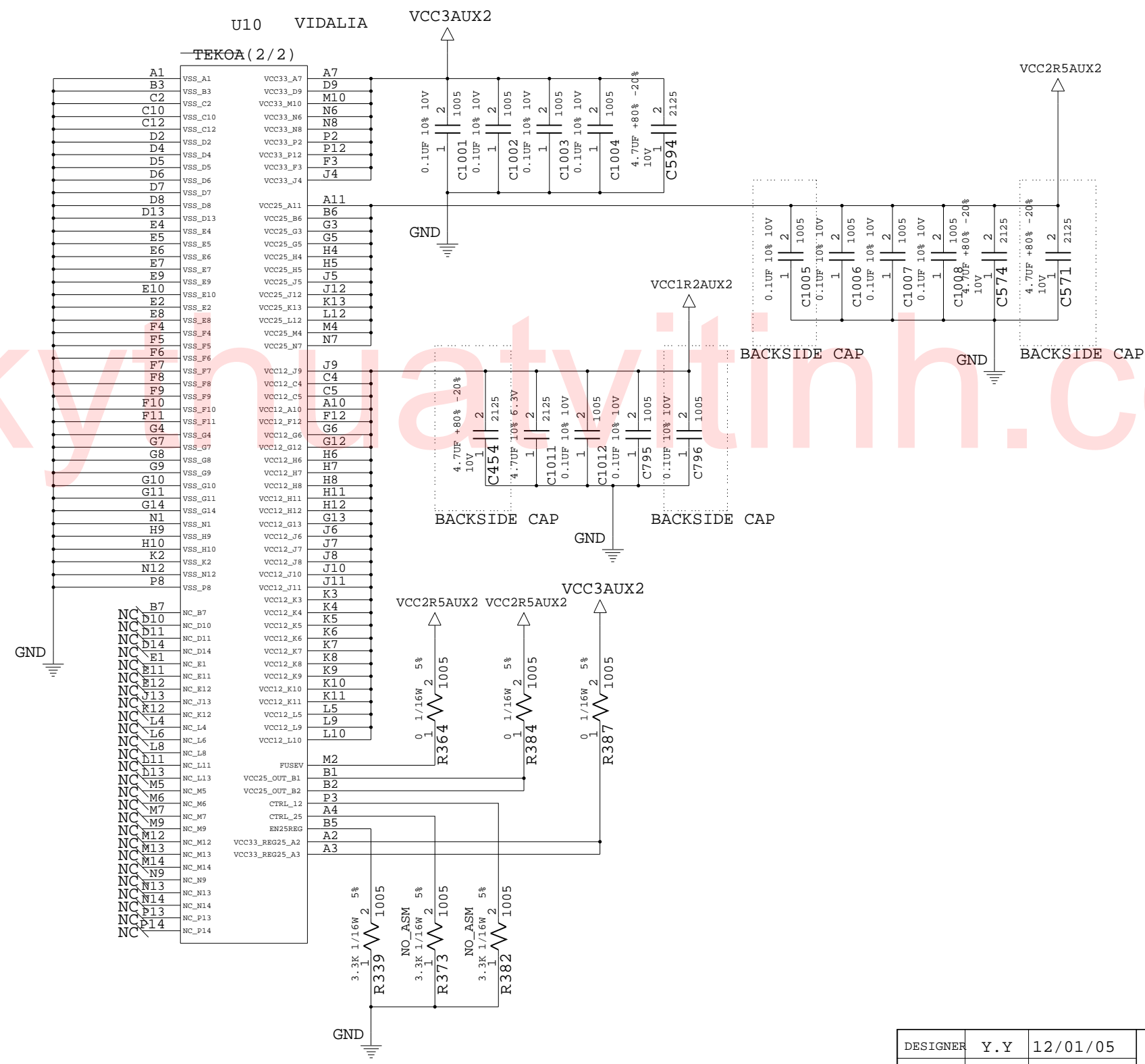

41W0930

DESIGNER	Y.Y	12/01/05	PART NO.	41W0930	<b>IBM</b>
CHECKED	Y.I	12/01/05	TITLE LISA-7(VER 5.04)		
APPROVED	T.S	12/01/05	GBE VIDALIA(2/2)		
CLASS			LENOVO CONFIDENTIAL		



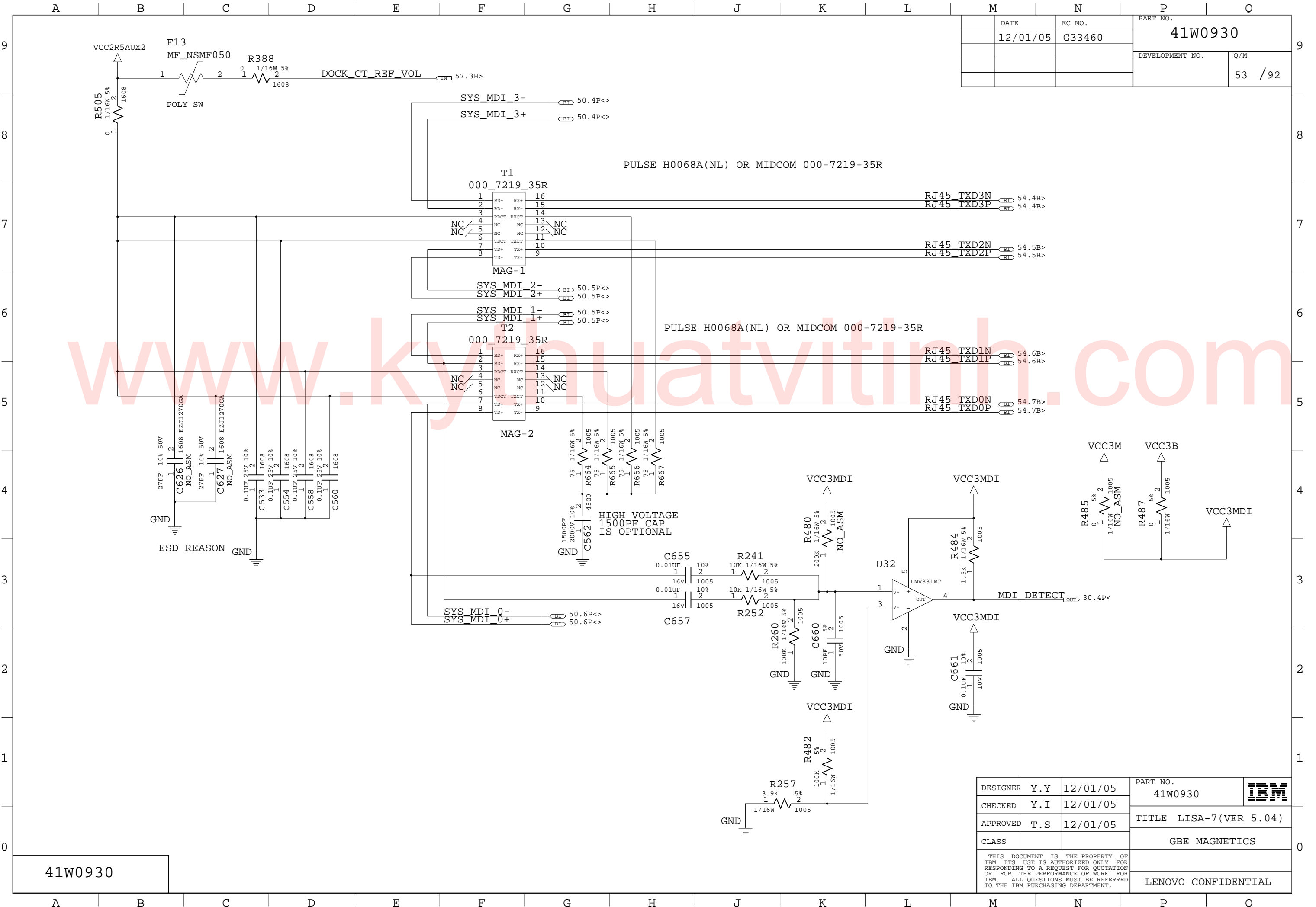

DATE	EC NO.	PART NO.
12/01/05	G33460	41W0930
DEVELOPMENT NO.		Q/M
		53 / 92

41W0930

DESIGNER	Y.Y	12/01/05	PART NO.	41W0930	
CHECKED	Y.I	12/01/05			
APPROVED	T.S	12/01/05	TITLE LISA-7(VER 5.04)		
CLASS			GBE MAGNETICS		
THIS DOCUMENT IS THE PROPERTY OF IBM. ITS USE IS AUTHORIZED ONLY FOR RESPONDING TO A REQUEST FOR QUOTATION OR FOR THE PERFORMANCE OF WORK FOR IBM. ALL QUESTIONS MUST BE REFERRED TO THE IBM PURCHASING DEPARTMENT.				LENOVO CONFIDENTIAL	

DATE	12/01/05	EC NO.	G33460	PART NO.	41W0930
				DEVELOPMENT NO.	54 / 92
				Q/M	

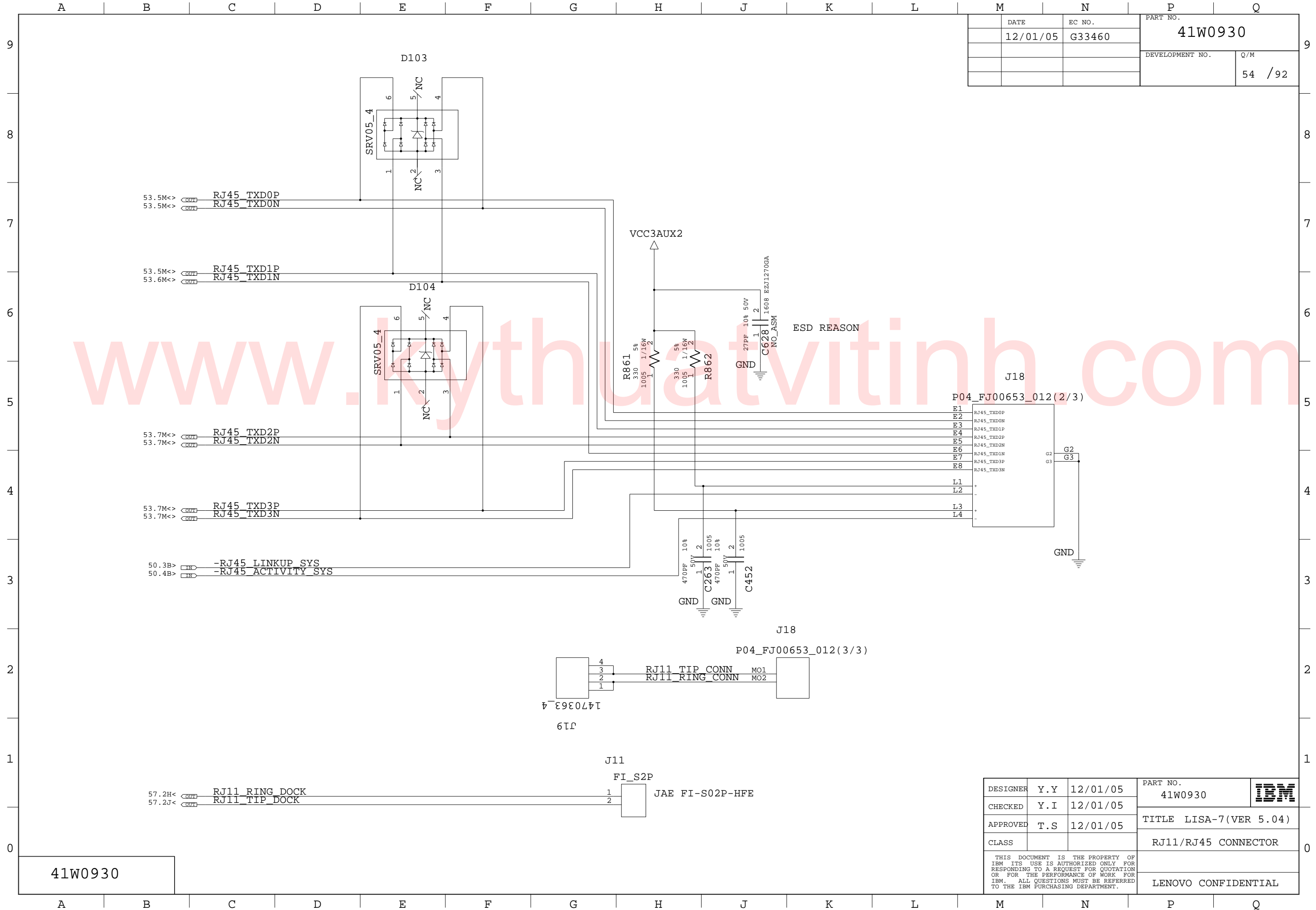

DESIGNER	Y.Y	12/01/05	PART NO.	41W0930	IBM
CHECKED	Y.I	12/01/05	TITLE LISA-7(VER 5.04)		
APPROVED	T.S	12/01/05	CLASS		RJ11/RJ45 CONNECTOR
THIS DOCUMENT IS THE PROPERTY OF IBM ITS USE IS AUTHORIZED ONLY FOR RESPONDING TO A REQUEST FOR QUOTATION OR FOR THE PERFORMANCE OF WORK FOR IBM. ALL QUESTIONS MUST BE REFERRED TO THE IBM PURCHASING DEPARTMENT.					LENOVO CONFIDENTIAL

41W0930

# MINI PCIE CONN-1 FOR WWAN

DATE	EC NO.	PART NO.
12/01/05	G33460	41W0930
DEVELOPMENT NO.		Q/M
		55 / 92

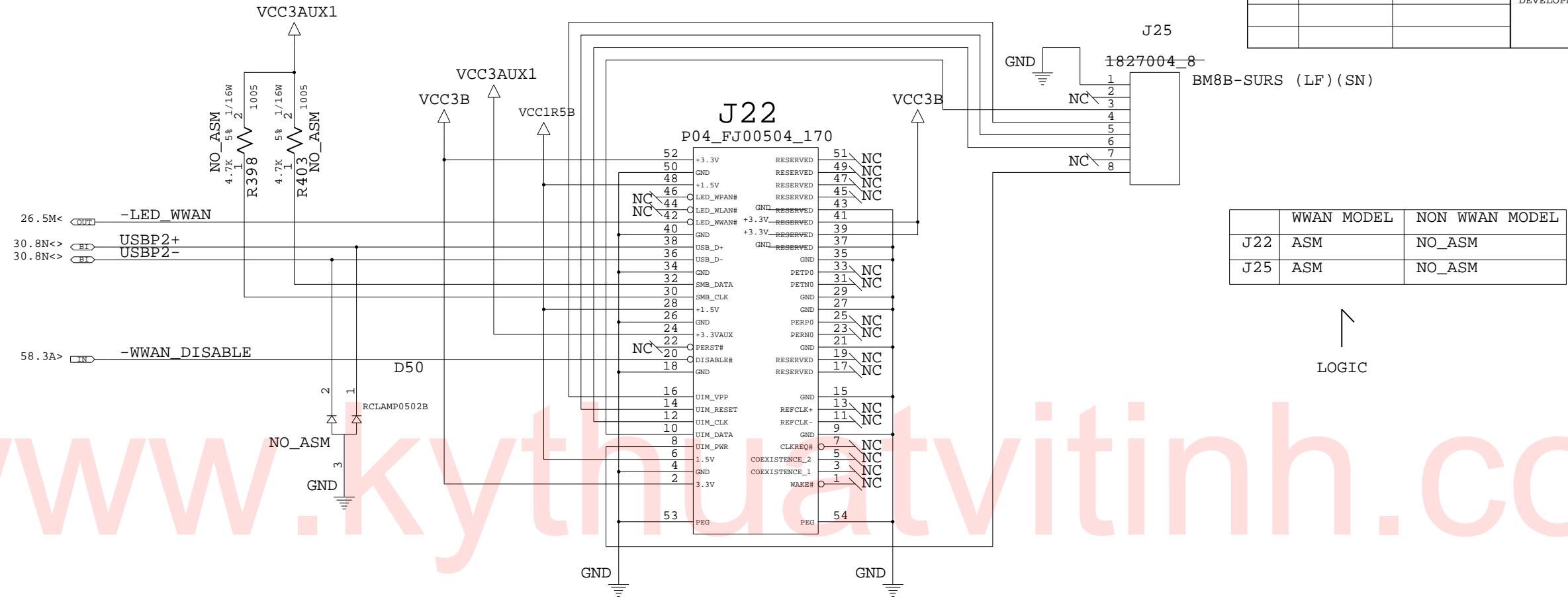

# MINI PCIE CONN-2 FOR WLAN

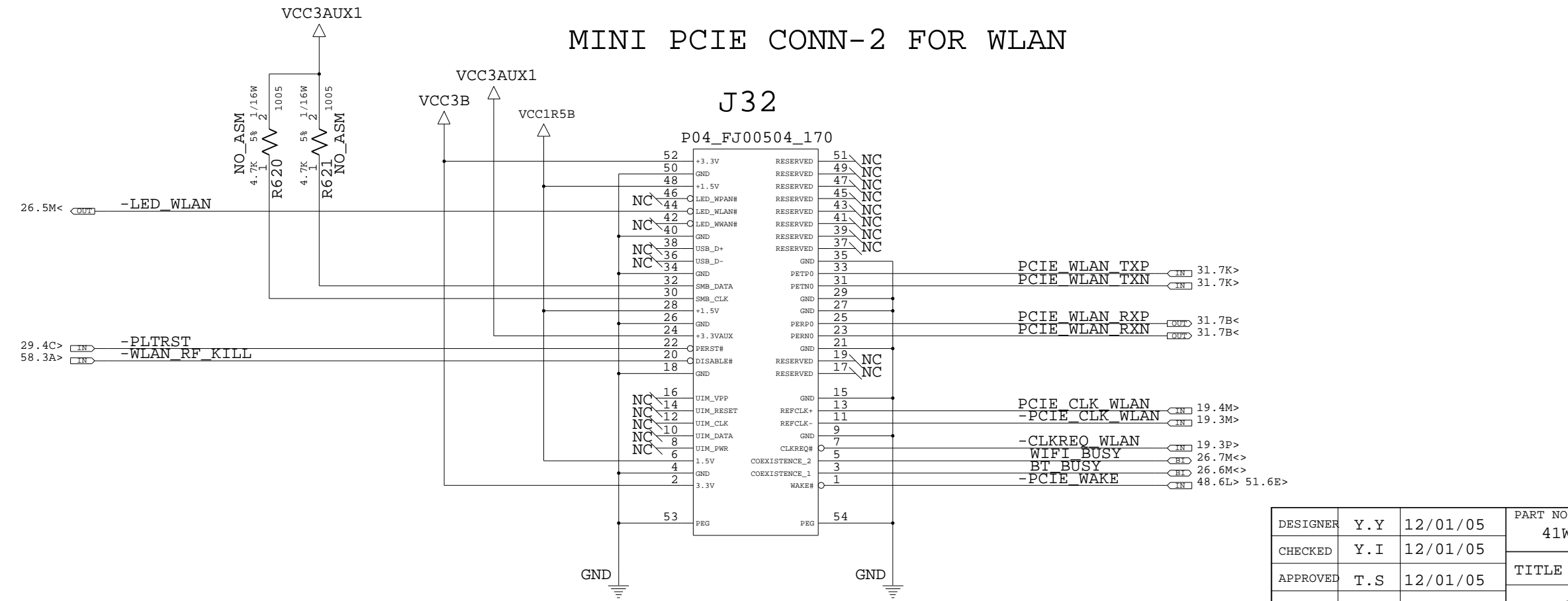

41W0930

THIS DOCUMENT IS THE PROPERTY OF IBM. ITS USE IS AUTHORIZED ONLY FOR RESPONDING TO A REQUEST FOR QUOTATION OR FOR THE PERFORMANCE OF WORK FOR IBM. ALL QUESTIONS MUST BE REFERRED TO THE IBM PURCHASING DEPARTMENT.

LENOVO CONFIDENTIAL

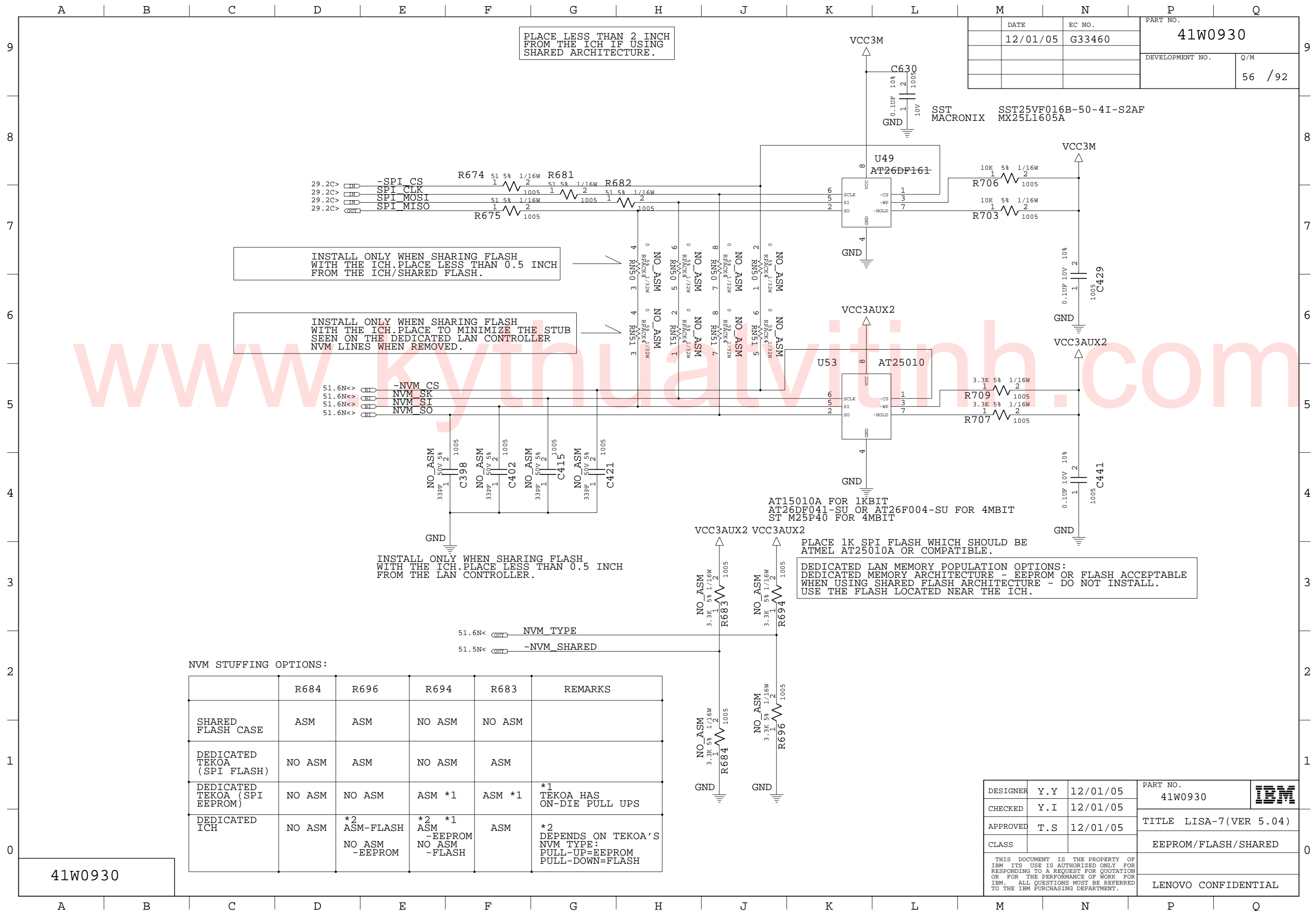

NVM STUFFING OPTIONS:

	R684	R696	R694	R683	REMARKS
SHARED FLASH CASE	ASM	ASM	NO ASM	NO ASM	
DEDICATED TEKOA (SPI FLASH)	NO ASM	ASM	NO ASM	ASM	
DEDICATED TEKOA (SPI EEPROM)	NO ASM	NO ASM	ASM *1	ASM *1	*1 TEKOA HAS ON-DIE PULL UPS
DEDICATED ICH	NO ASM	*2 ASM-FLASH NO ASM -EEPROM	*2 *1 ASM -EEPROM NO ASM -FLASH	ASM	*2 DEPENDS ON TEKOA'S NVM TYPE: PULL-UP=EEPROM PULL-DOWN=FLASH

41W0930

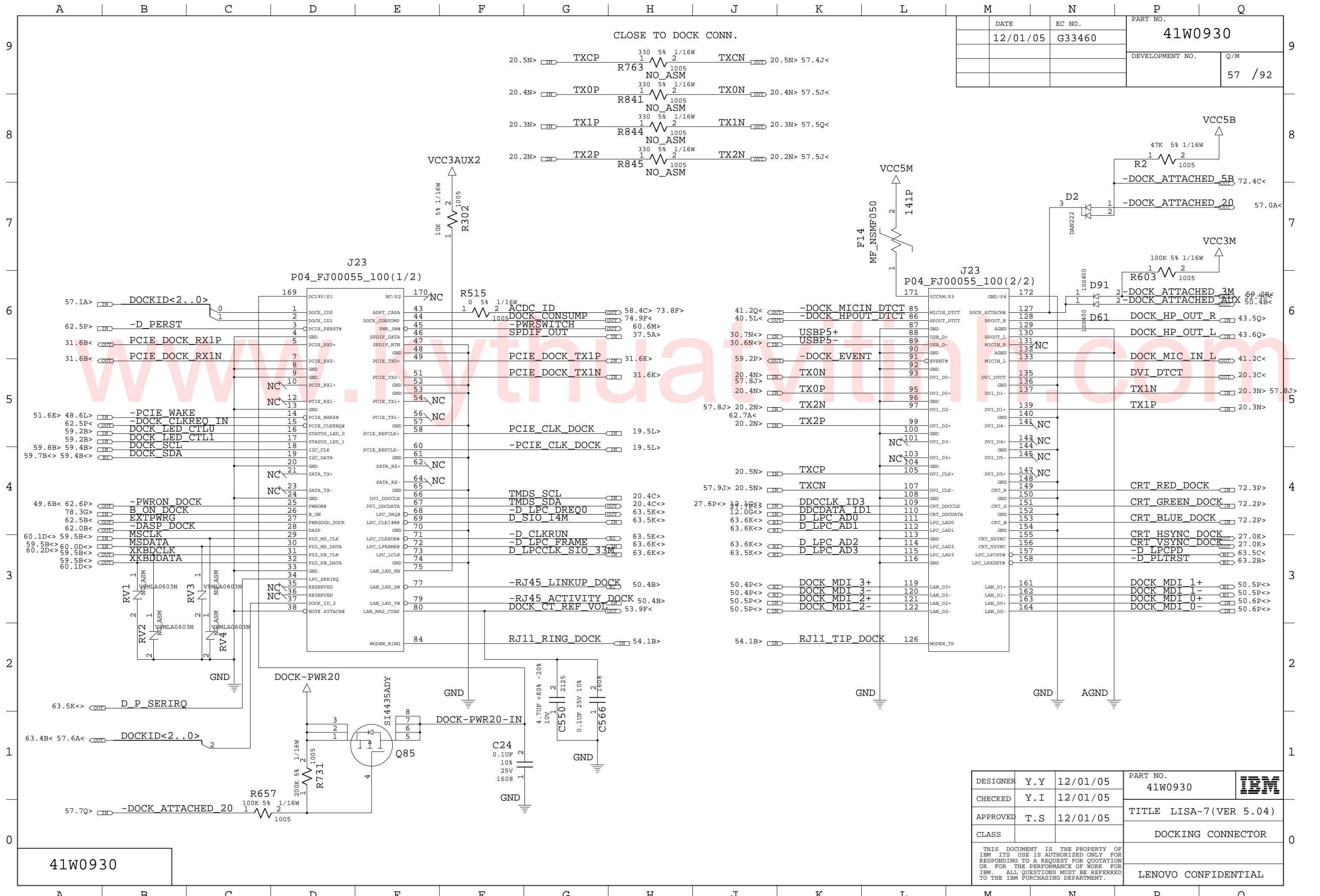

DATE	EC NO.	PART NO.	
12/01/05	G33460	41W0930	
		DEVELOPMENT NO.	Q/M
			57 / 92

DESIGNER	Y.Y	12/01/05	PART NO.	41W0930	
CHECKED	Y.I	12/01/05	TITLE		
APPROVED	T.S	12/01/05	DOCKING CONNECTOR		
CLASS			LENOVO CONFIDENTIAL		

THIS DOCUMENT IS THE PROPERTY OF IBM. ITS USE IS AUTHORIZED ONLY FOR RESPONDING TO A REQUEST FOR QUOTATION OR FOR THE PERFORMANCE OF WORK FOR IBM. ALL QUESTIONS MUST BE REFERRED TO THE IBM PURCHASING DEPARTMENT.

41W0930



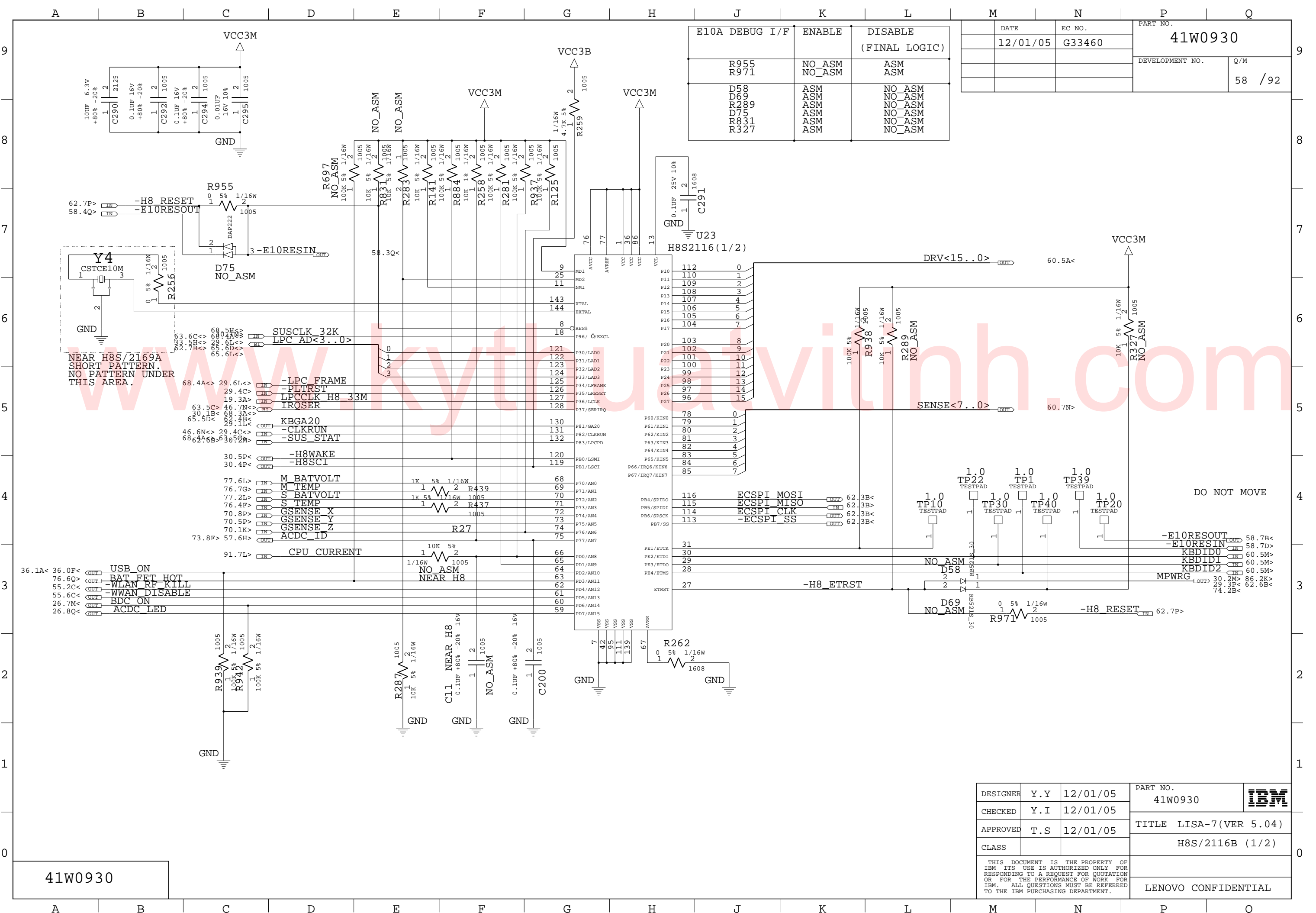

E10A DEBUG I/F	ENABLE	DISABLE (FINAL LOGIC)
R955 R971	NO_ASM NO_ASM	ASM ASM
D58 D69 R289 D75 R831 R327	ASM ASM ASM ASM ASM ASM	NO_ASM NO_ASM NO_ASM NO_ASM NO_ASM NO_ASM

DATE	EC NO.	PART NO.
12/01/05	G33460	41W0930
		DEVELOPMENT NO.
		Q/M
		58 / 92

DESIGNER	Y.Y	12/01/05	PART NO.	41W0930	<b>IBM</b>
CHECKED	Y.I	12/01/05	TITLE	LISA-7(VER 5.04)	
APPROVED	T.S	12/01/05		H8S/2116B (1/2)	
CLASS					
THIS DOCUMENT IS THE PROPERTY OF IBM ITS USE IS AUTHORIZED ONLY FOR RESPONDING TO A REQUEST FOR QUOTATION OR FOR THE PERFORMANCE OF WORK FOR IBM. ALL QUESTIONS MUST BE REFERRED TO THE IBM PURCHASING DEPARTMENT.					LENOVO CONFIDENTIAL

41W0930

DO NOT MOVE



DATE	EC NO.	PART NO.
12/01/05	G33460	41W0930
		DEVELOPMENT NO.
		Q/M
		59 /92

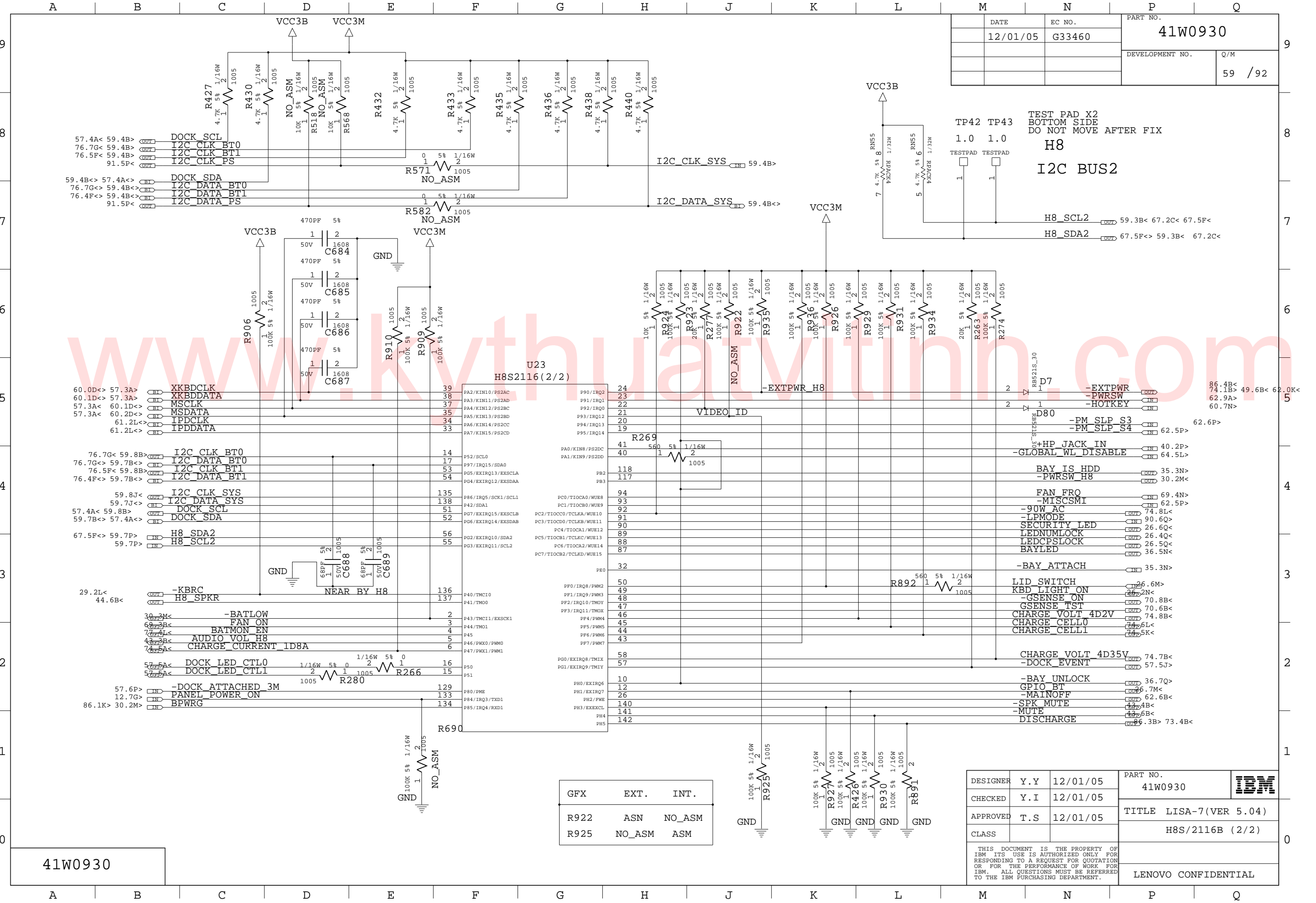
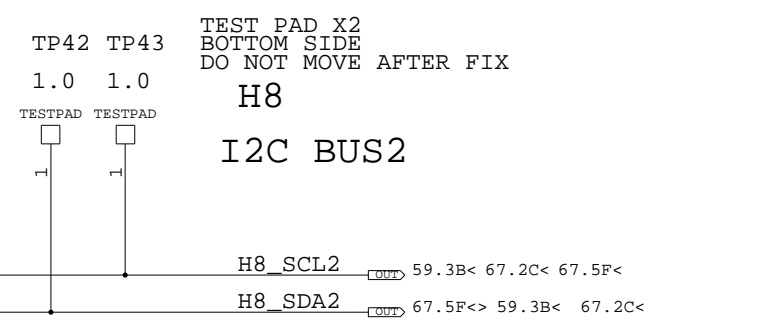

GFX	EXT.	INT.
R922	ASN	NO_ASM
R925	NO_ASM	ASM

DESIGNER	Y.Y	12/01/05	PART NO.	41W0930	
CHECKED	Y.I	12/01/05	TITLE	LISA-7(VER 5.04)	
APPROVED	T.S	12/01/05		H8S/2116B (2/2)	
CLASS					
THIS DOCUMENT IS THE PROPERTY OF IBM ITS USE IS AUTHORIZED ONLY FOR RESPONDING TO A REQUEST FOR QUOTATION OR FOR THE PERFORMANCE OF WORK FOR IBM. ALL QUESTIONS MUST BE REFERRED TO THE IBM PURCHASING DEPARTMENT.					LENOVO CONFIDENTIAL

41W0930

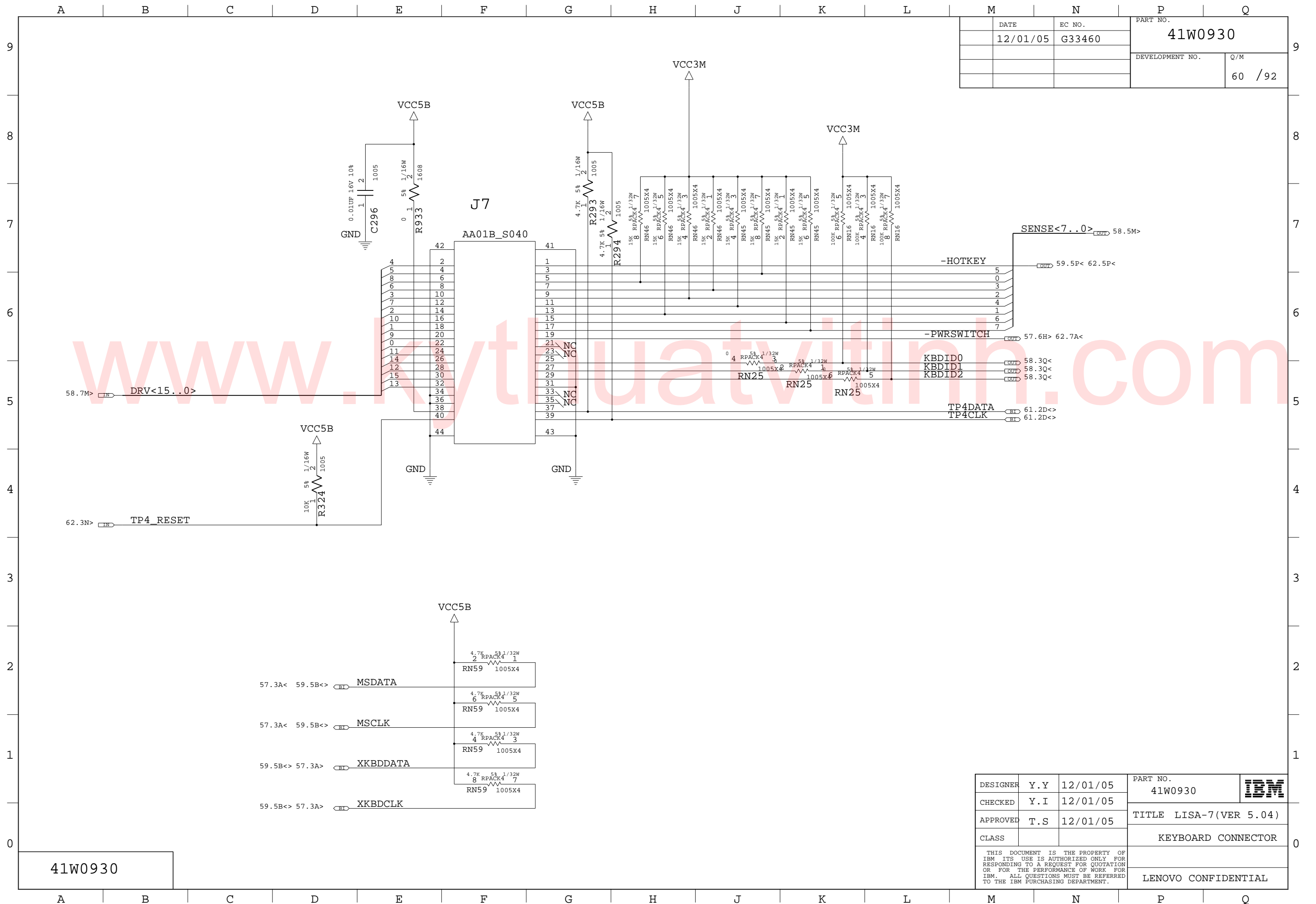

DATE	EC NO.	PART NO.	
12/01/05	G33460	41W0930	
		DEVELOPMENT NO.	Q/M
			60 / 92

41W0930

DESIGNER	Y.Y	12/01/05	PART NO.	41W0930	
CHECKED	Y.I	12/01/05			
APPROVED	T.S	12/01/05	TITLE LISA-7(VER 5.04)		
CLASS			KEYBOARD CONNECTOR		
THIS DOCUMENT IS THE PROPERTY OF IBM. ITS USE IS AUTHORIZED ONLY FOR RESPONDING TO A REQUEST FOR QUOTATION OR FOR THE PERFORMANCE OF WORK FOR IBM. ALL QUESTIONS MUST BE REFERRED TO THE IBM PURCHASING DEPARTMENT.				LENOVO CONFIDENTIAL	

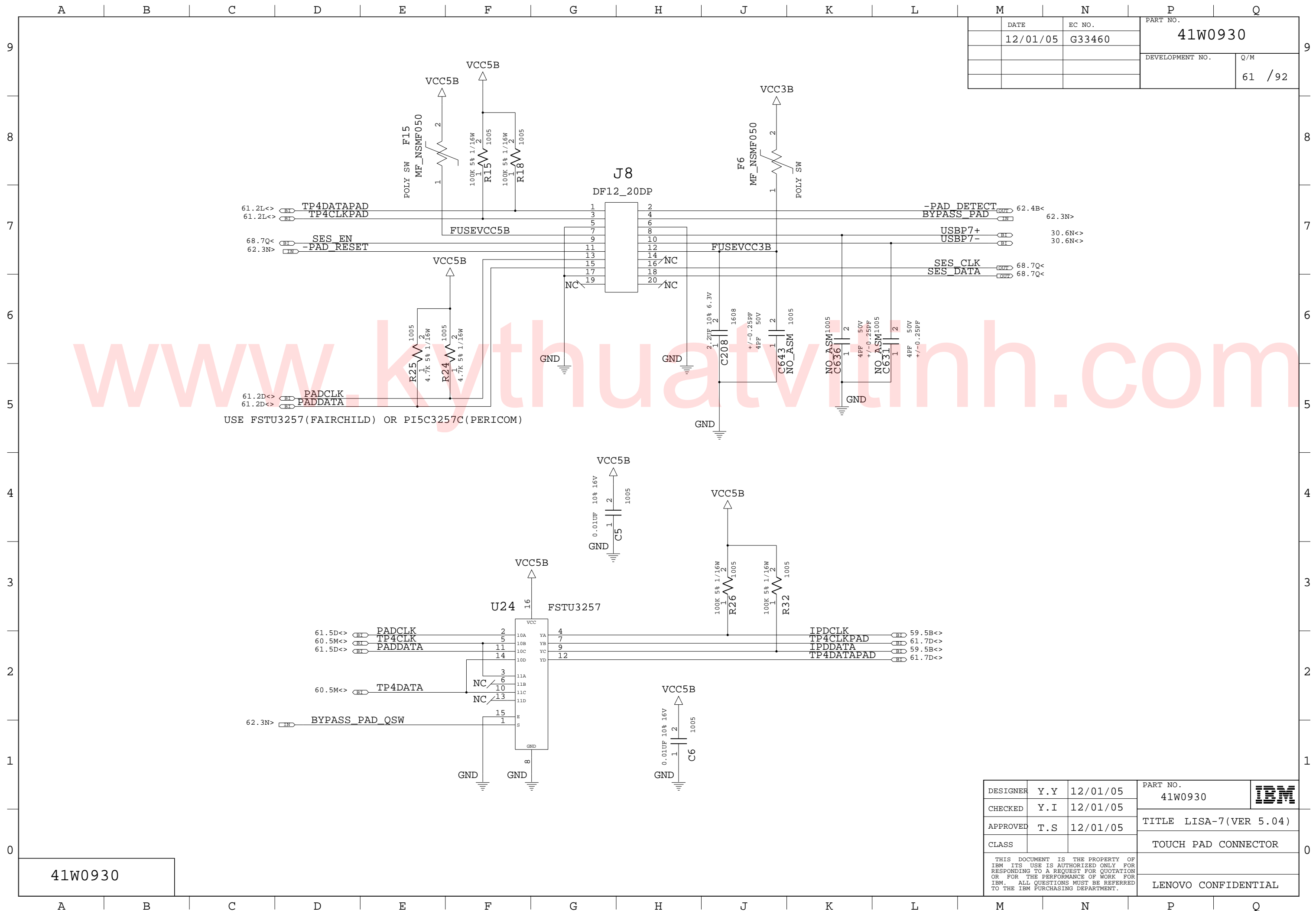

DATE	EC NO.	PART NO.	
12/01/05	G33460	41W0930	
		DEVELOPMENT NO.	Q/M
			61 / 92

41W0930

DESIGNER	Y.Y	12/01/05	PART NO.	41W0930	
CHECKED	Y.I	12/01/05			
APPROVED	T.S	12/01/05	TITLE LISA-7(VER 5.04)		
CLASS			TOUCH PAD CONNECTOR		
THIS DOCUMENT IS THE PROPERTY OF IBM ITS USE IS AUTHORIZED ONLY FOR RESPONDING TO A REQUEST FOR QUOTATION OR FOR THE PERFORMANCE OF WORK FOR IBM. ALL QUESTIONS MUST BE REFERRED TO THE IBM PURCHASING DEPARTMENT.				LENOVO CONFIDENTIAL	

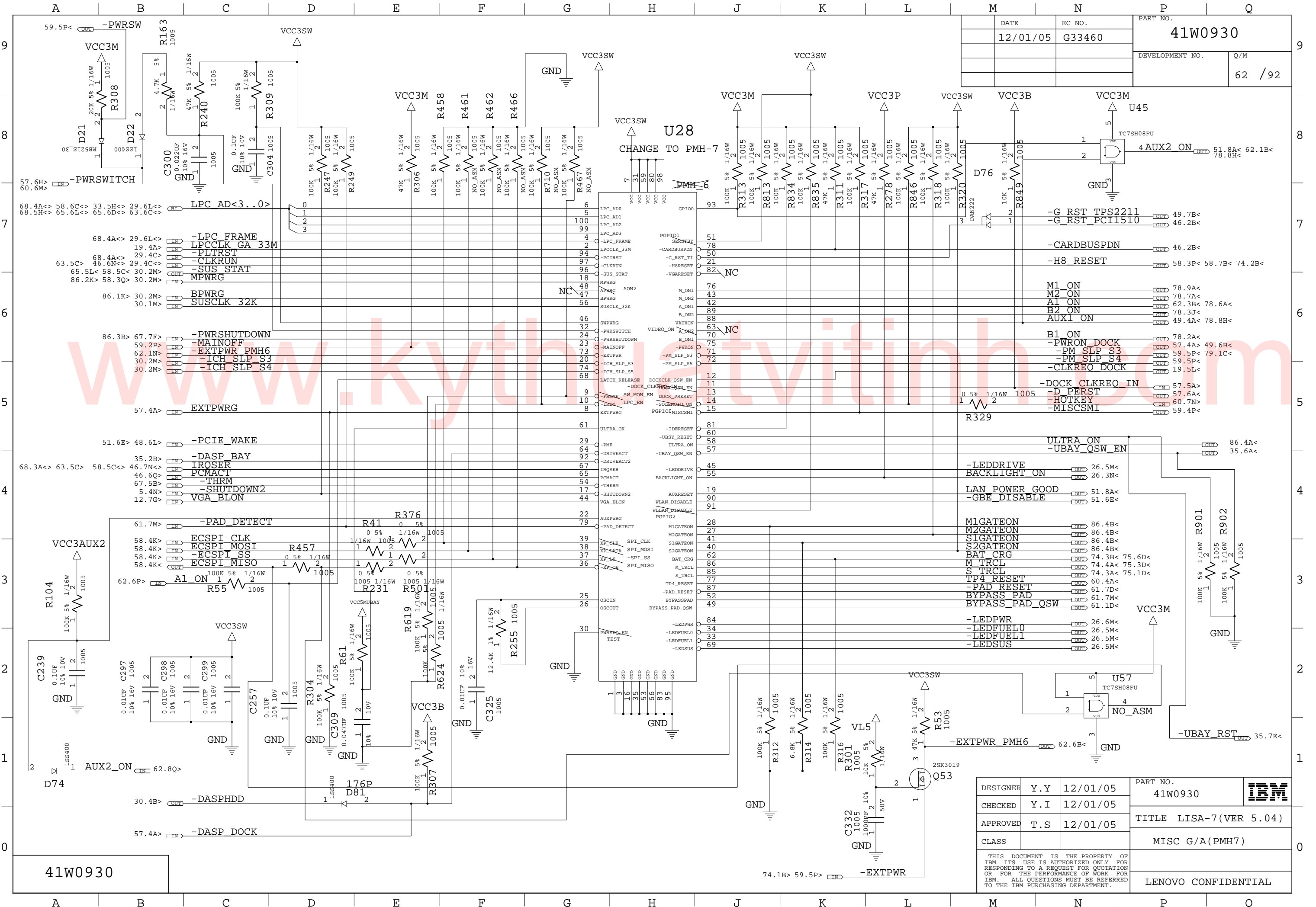

DATE	EC NO.	PART NO.
12/01/05	G33460	41W0930
DEVELOPMENT NO.		Q/M
		62 / 92

DESIGNER	Y.Y	12/01/05	PART NO.	41W0930	
CHECKED	Y.I	12/01/05	TITLE LISA-7(VER 5.04)		
APPROVED	T.S	12/01/05	MISC G/A(PM7)		
CLASS			LENOVO CONFIDENTIAL		

41W0930

THIS DOCUMENT IS THE PROPERTY OF IBM ITS USE IS AUTHORIZED ONLY FOR RESPONDING TO A REQUEST FOR QUOTATION OR FOR THE PERFORMANCE OF WORK FOR IBM. ALL QUESTIONS MUST BE REFERRED TO THE IBM PURCHASING DEPARTMENT.

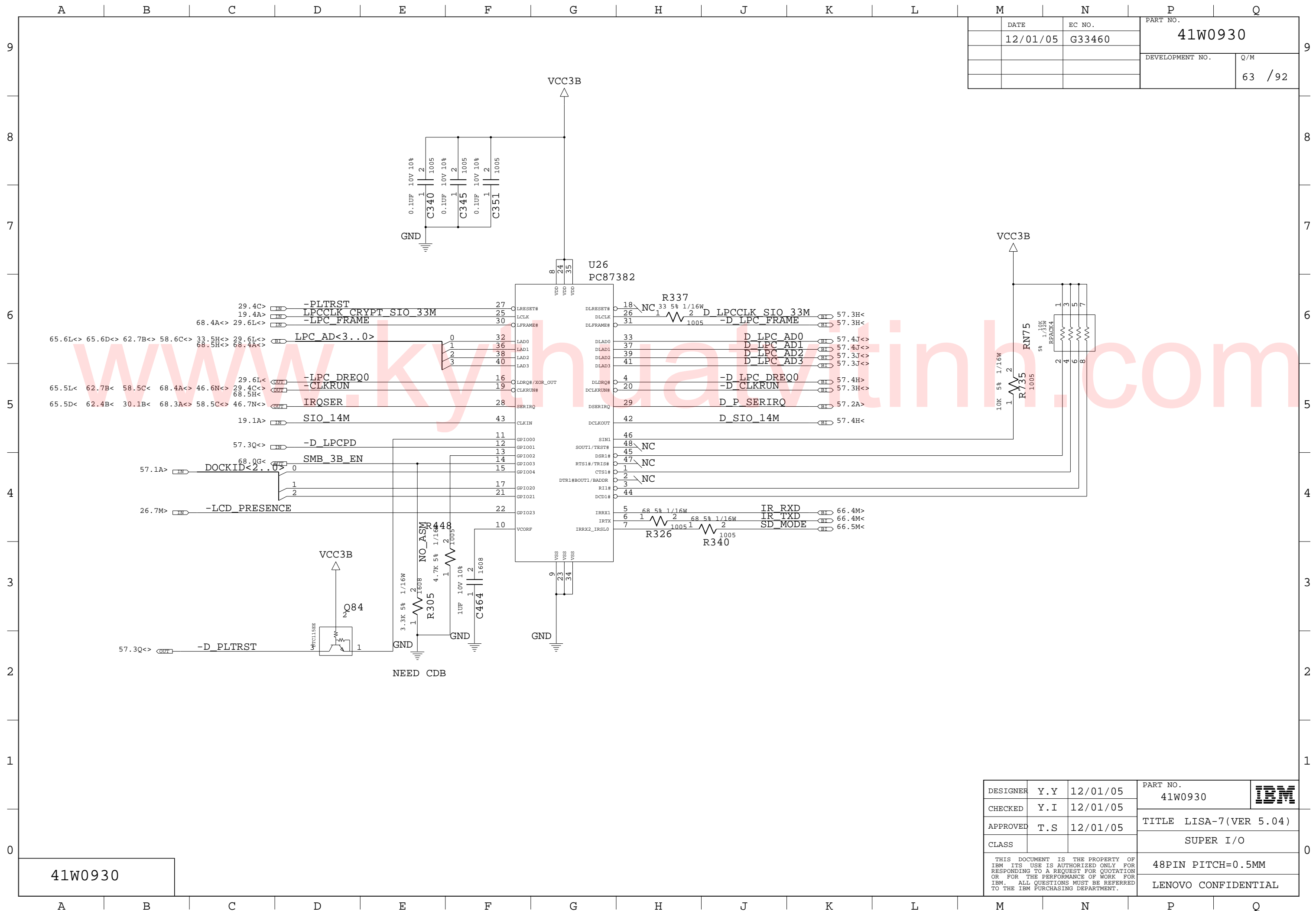

DATE	EC NO.	PART NO.	
12/01/05	G33460	41W0930	
		DEVELOPMENT NO.	Q/M
			63 / 92

41W0930

DESIGNER	Y.Y	12/01/05	PART NO.	41W0930	
CHECKED	Y.I	12/01/05			
APPROVED	T.S	12/01/05	TITLE LISA-7(VER 5.04)		
CLASS			SUPER I/O		
THIS DOCUMENT IS THE PROPERTY OF IBM ITS USE IS AUTHORIZED ONLY FOR RESPONDING TO A REQUEST FOR QUOTATION OR FOR THE PERFORMANCE OF WORK FOR IBM. ALL QUESTIONS MUST BE REFERRED TO THE IBM PURCHASING DEPARTMENT.				48PIN PITCH=0.5MM	
				LENOVO CONFIDENTIAL	

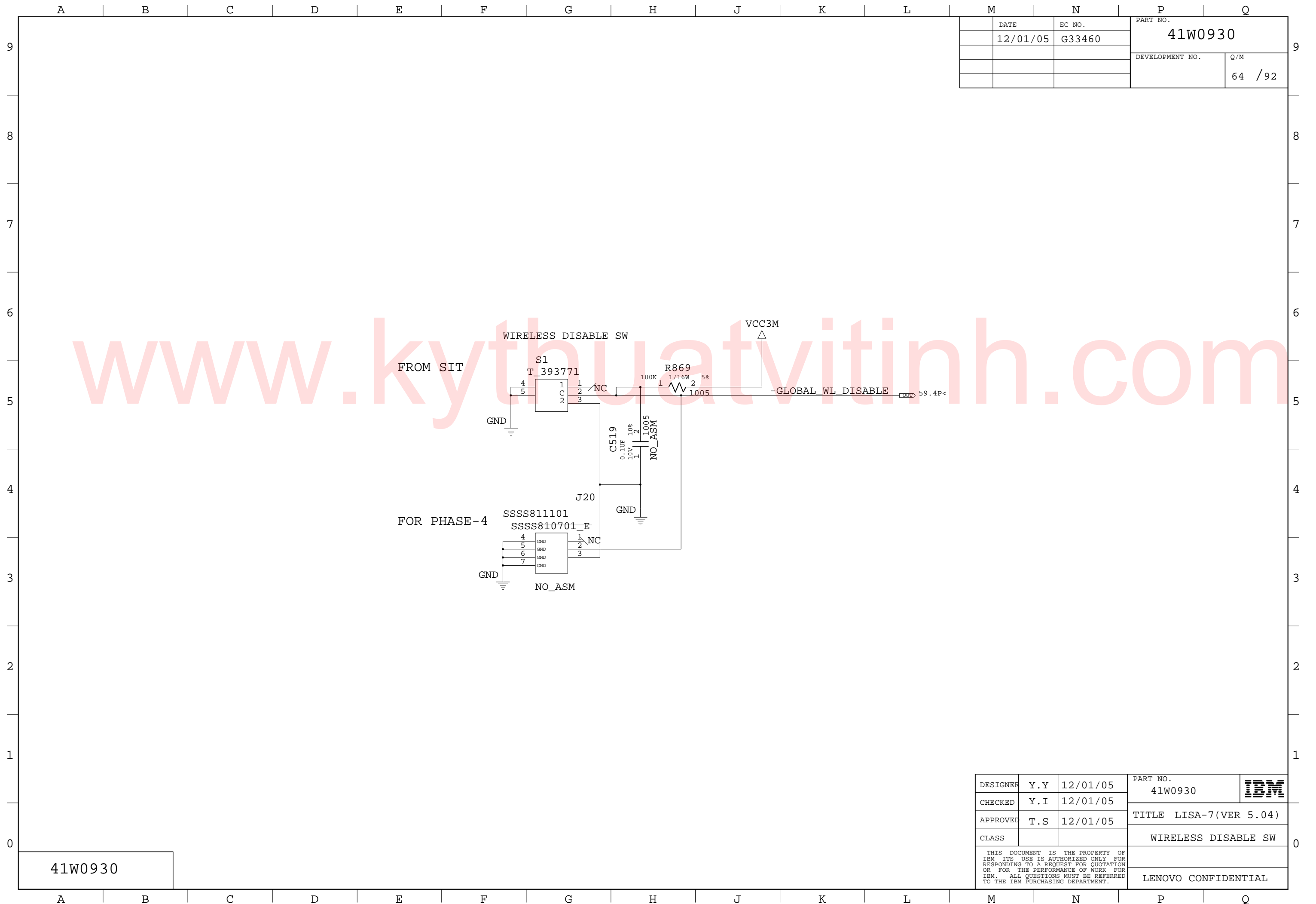

DATE	EC NO.	PART NO.	
12/01/05	G33460	41W0930	
		DEVELOPMENT NO.	Q/M
			64 /92

41W0930

DESIGNER	Y.Y	12/01/05	PART NO.	41W0930	<b>IBM</b>
CHECKED	Y.I	12/01/05			
APPROVED	T.S	12/01/05	TITLE LISA-7(VER 5.04)		
CLASS			WIRELESS DISABLE SW		
THIS DOCUMENT IS THE PROPERTY OF IBM ITS USE IS AUTHORIZED ONLY FOR RESPONDING TO A REQUEST FOR QUOTATION OR FOR THE PERFORMANCE OF WORK FOR IBM. ALL QUESTIONS MUST BE REFERRED TO THE IBM PURCHASING DEPARTMENT.				LENOVO CONFIDENTIAL	



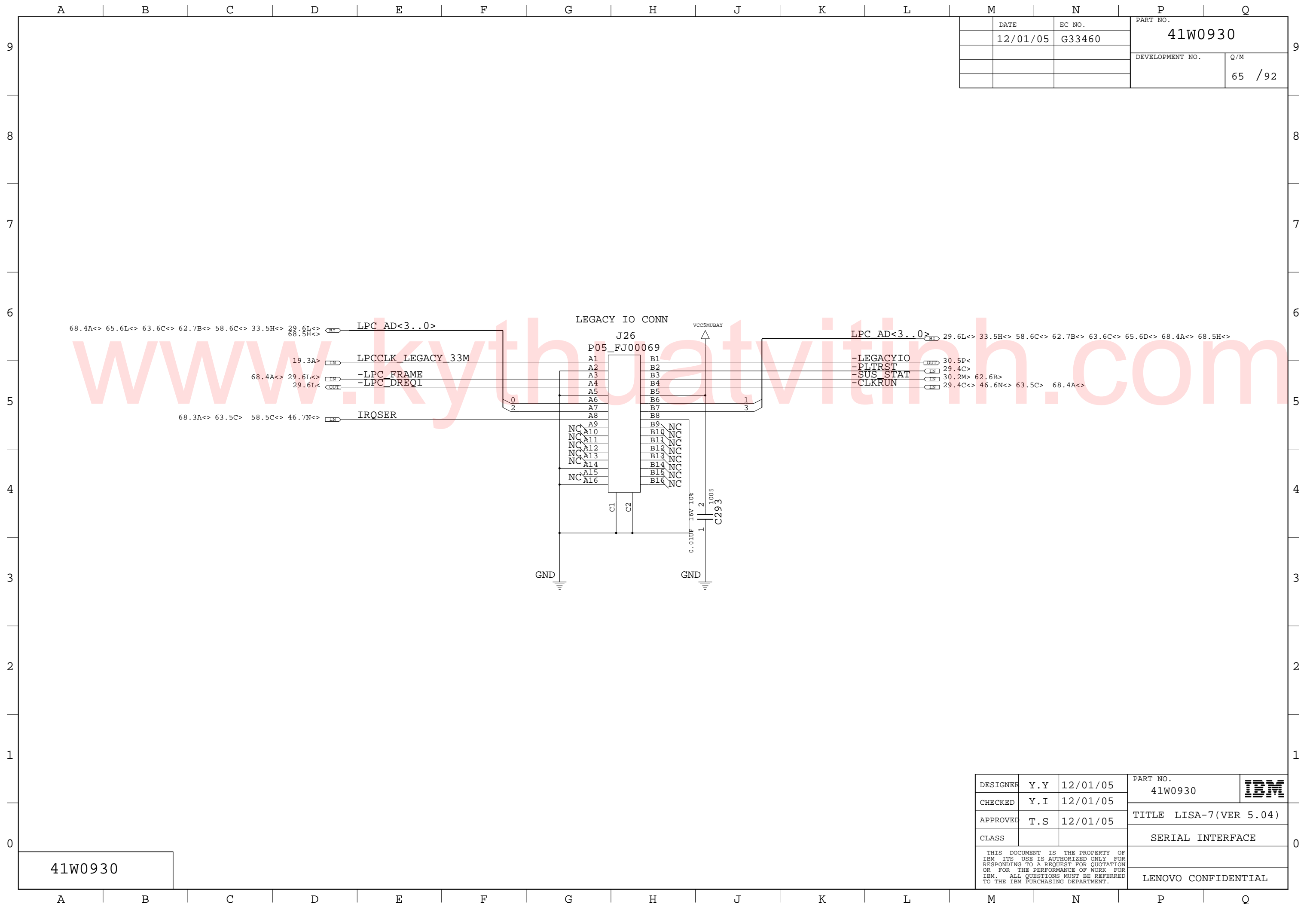

DATE	EC NO.	PART NO.	
12/01/05	G33460	41W0930	
		DEVELOPMENT NO.	Q/M
			65 /92

41W0930

DESIGNER	Y.Y	12/01/05	PART NO.	41W0930	<b>IBM</b>
CHECKED	Y.I	12/01/05			
APPROVED	T.S	12/01/05	TITLE LISA-7(VER 5.04)		
CLASS			SERIAL INTERFACE		
THIS DOCUMENT IS THE PROPERTY OF IBM ITS USE IS AUTHORIZED ONLY FOR RESPONDING TO A REQUEST FOR QUOTATION OR FOR THE PERFORMANCE OF WORK FOR IBM. ALL QUESTIONS MUST BE REFERRED TO THE IBM PURCHASING DEPARTMENT.					LENOVO CONFIDENTIAL



DATE	EC NO.	PART NO.	
12/01/05	G33460	41W0930	
		DEVELOPMENT NO.	Q/M
		67	/92

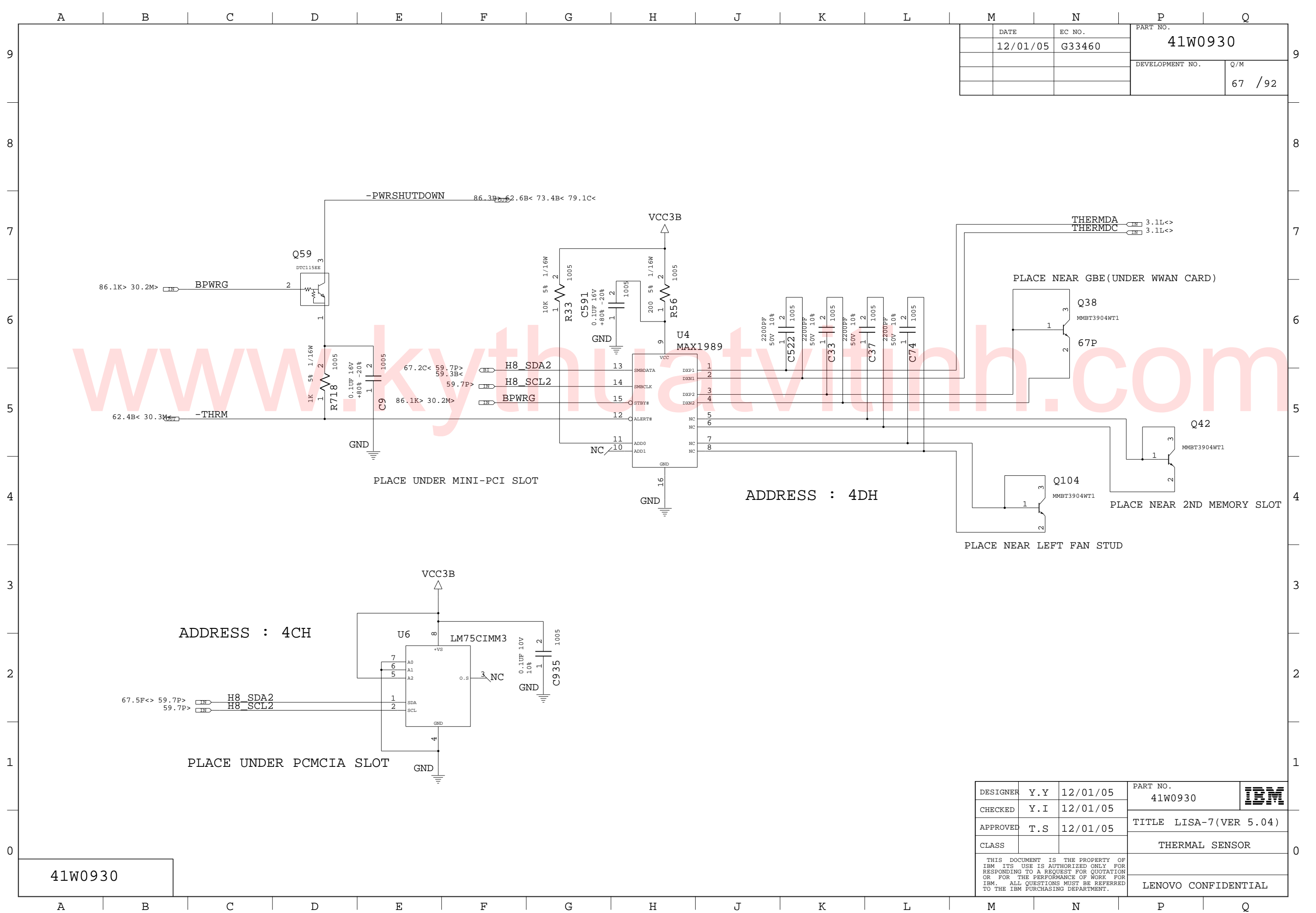

41W0930

DESIGNER	Y.Y	12/01/05	PART NO.	41W0930	IBM
CHECKED	Y.I	12/01/05			
APPROVED	T.S	12/01/05	TITLE LISA-7(VER 5.04)		
CLASS			THERMAL SENSOR		
THIS DOCUMENT IS THE PROPERTY OF IBM ITS USE IS AUTHORIZED ONLY FOR RESPONDING TO A REQUEST FOR QUOTATION OR FOR THE PERFORMANCE OF WORK FOR IBM. ALL QUESTIONS MUST BE REFERRED TO THE IBM PURCHASING DEPARTMENT.					LENOVO CONFIDENTIAL

DATE	12/01/05	EC NO.	G33460	PART NO.	41W0930	
				DEVELOPMENT NO.	Q/M	
				68 /92		

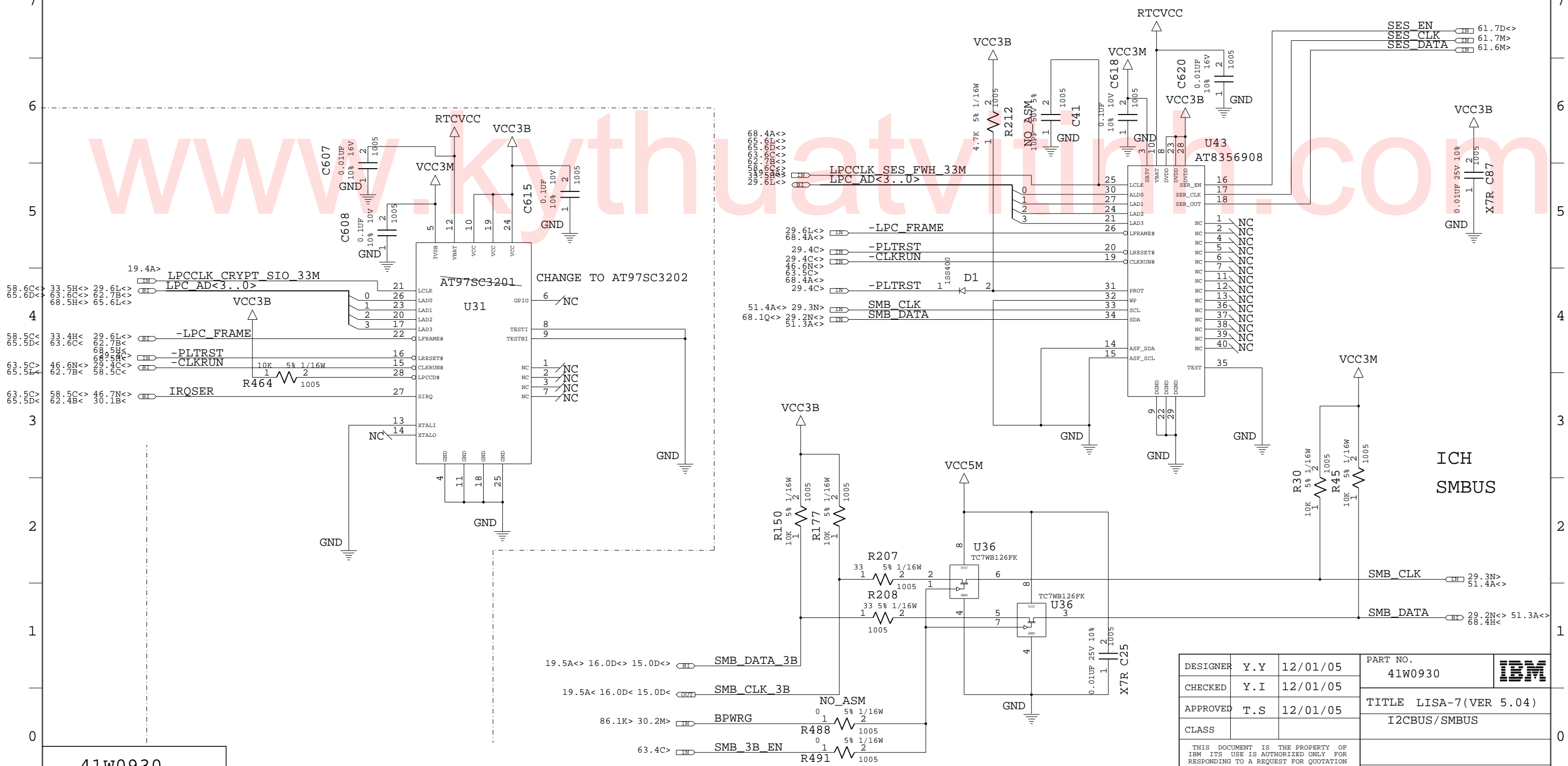

41W0930

DESIGNER	Y.Y	12/01/05	PART NO.	41W0930	
CHECKED	Y.I	12/01/05	TITLE LISA-7(VER 5.04)		
APPROVED	T.S	12/01/05	I2CBUS/SMBUS		
CLASS					
THIS DOCUMENT IS THE PROPERTY OF IBM ITS USE IS AUTHORIZED ONLY FOR RESPONDING TO A REQUEST FOR QUOTATION OR FOR THE PERFORMANCE OF WORK FOR IBM. ALL QUESTIONS MUST BE REFERRED TO THE IBM PURCHASING DEPARTMENT.					LENOVO CONFIDENTIAL

	DATE	EC NO.	PART NO.	
	12/01/05	G33460	41W0930	
			DEVELOPMENT NO.	Q/M
				69 / 92

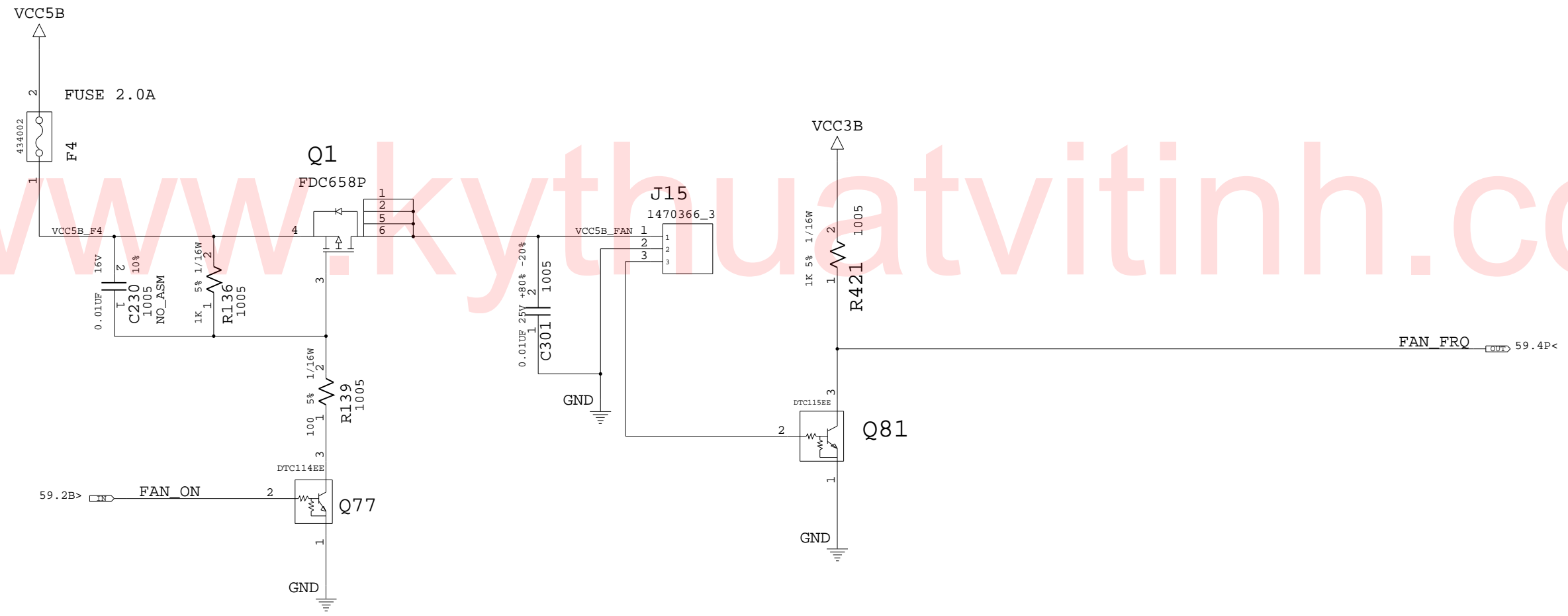

41W0930

DESIGNER	Y.Y	12/01/05	PART NO.	41W0930	
CHECKED	Y.I	12/01/05			
APPROVED	T.S	12/01/05	TITLE LISA-7(VER 5.04)		
CLASS			FAN CONNECTOR		
THIS DOCUMENT IS THE PROPERTY OF IBM ITS USE IS AUTHORIZED ONLY FOR RESPONDING TO A REQUEST FOR QUOTATION OR FOR THE PERFORMANCE OF WORK FOR IBM. ALL QUESTIONS MUST BE REFERRED TO THE IBM PURCHASING DEPARTMENT.				LENOVO CONFIDENTIAL	

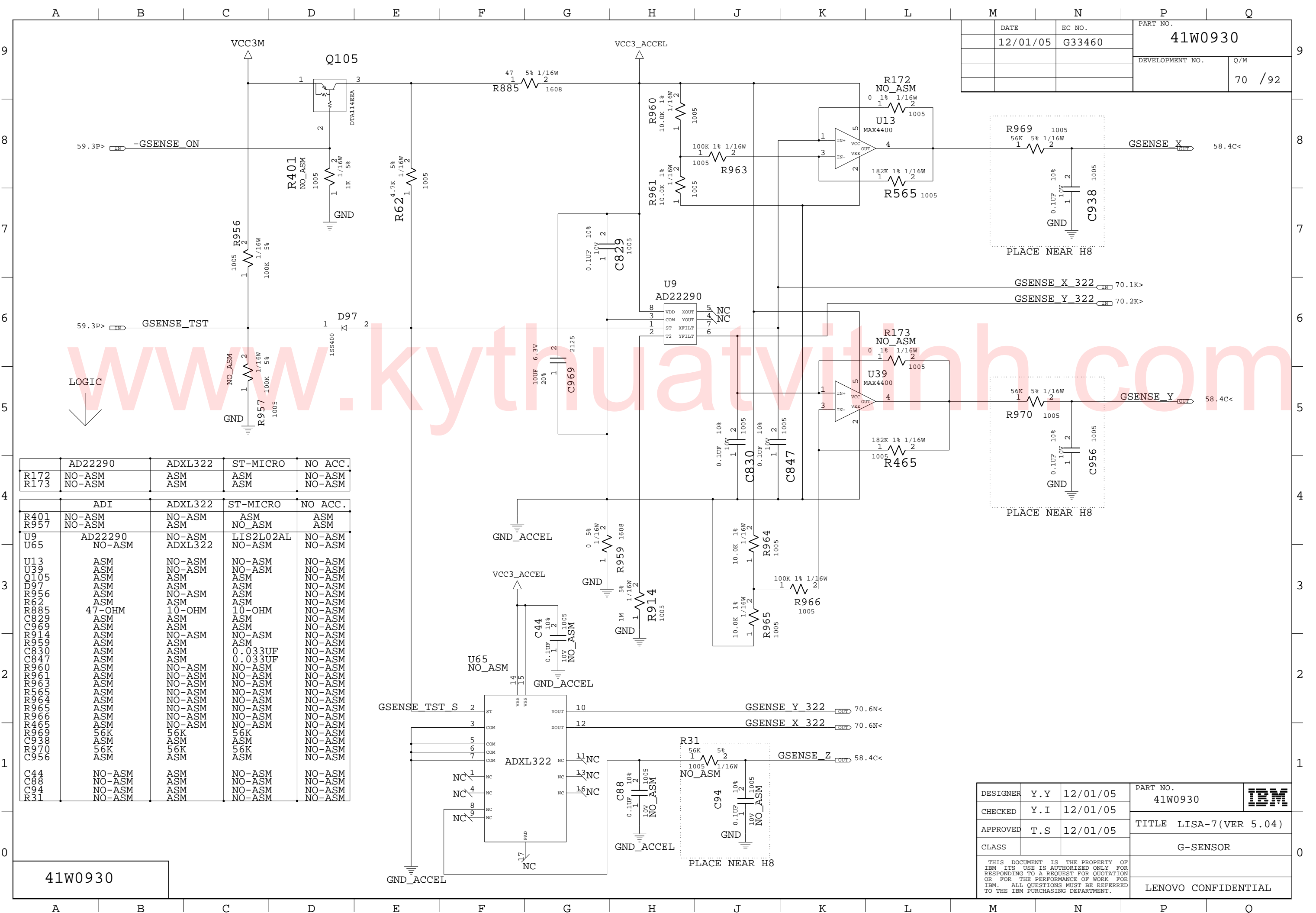

DATE	EC NO.	PART NO.
12/01/05	G33460	41W0930
DEVELOPMENT NO.		Q/M
		70 / 92

	AD22290	ADXL322	ST-MICRO	NO ACC.
R172	NO-ASM	ASM	ASM	NO-ASM
R173	NO-ASM	ASM	ASM	NO-ASM
	ADI	ADXL322	ST-MICRO	NO ACC.
R401	NO-ASM	NO-ASM	ASM	ASM
R957	NO-ASM	ASM	NO-ASM	ASM
U9	AD22290	NO-ASM	LIS2L02AL	NO-ASM
U65	NO-ASM	ADXL322	NO-ASM	NO-ASM
U13	ASM	NO-ASM	NO-ASM	NO-ASM
U39	ASM	NO-ASM	NO-ASM	NO-ASM
Q105	ASM	ASM	ASM	NO-ASM
D97	ASM	ASM	ASM	NO-ASM
R956	ASM	NO-ASM	NO-ASM	NO-ASM
R957	ASM	NO-ASM	NO-ASM	NO-ASM
R959	ASM	NO-ASM	NO-ASM	NO-ASM
R960	ASM	NO-ASM	NO-ASM	NO-ASM
R961	ASM	NO-ASM	NO-ASM	NO-ASM
R963	ASM	NO-ASM	NO-ASM	NO-ASM
R964	ASM	NO-ASM	NO-ASM	NO-ASM
R965	ASM	NO-ASM	NO-ASM	NO-ASM
R966	ASM	NO-ASM	NO-ASM	NO-ASM
R465	ASM	NO-ASM	NO-ASM	NO-ASM
R473	ASM	NO-ASM	NO-ASM	NO-ASM
R565	ASM	NO-ASM	NO-ASM	NO-ASM
R566	ASM	NO-ASM	NO-ASM	NO-ASM
R569	ASM	NO-ASM	NO-ASM	NO-ASM
R62	ASM	NO-ASM	NO-ASM	NO-ASM
R66	ASM	NO-ASM	NO-ASM	NO-ASM
R69	ASM	NO-ASM	NO-ASM	NO-ASM
R70	ASM	NO-ASM	NO-ASM	NO-ASM
R73	ASM	NO-ASM	NO-ASM	NO-ASM
R885	ASM	NO-ASM	NO-ASM	NO-ASM
C44	NO-ASM	ASM	NO-ASM	NO-ASM
C88	NO-ASM	ASM	NO-ASM	NO-ASM
C94	NO-ASM	ASM	NO-ASM	NO-ASM
R31	NO-ASM	ASM	NO-ASM	NO-ASM

41W0930

DESIGNER	Y.Y	12/01/05	PART NO.	41W0930	
CHECKED	Y.I	12/01/05	TITLE LISA-7(VER 5.04)		
APPROVED	T.S	12/01/05	G-SENSOR		
CLASS					
THIS DOCUMENT IS THE PROPERTY OF IBM ITS USE IS AUTHORIZED ONLY FOR RESPONDING TO A REQUEST FOR QUOTATION OR FOR THE PERFORMANCE OF WORK FOR IBM. ALL QUESTIONS MUST BE REFERRED TO THE IBM PURCHASING DEPARTMENT.					LENOVO CONFIDENTIAL



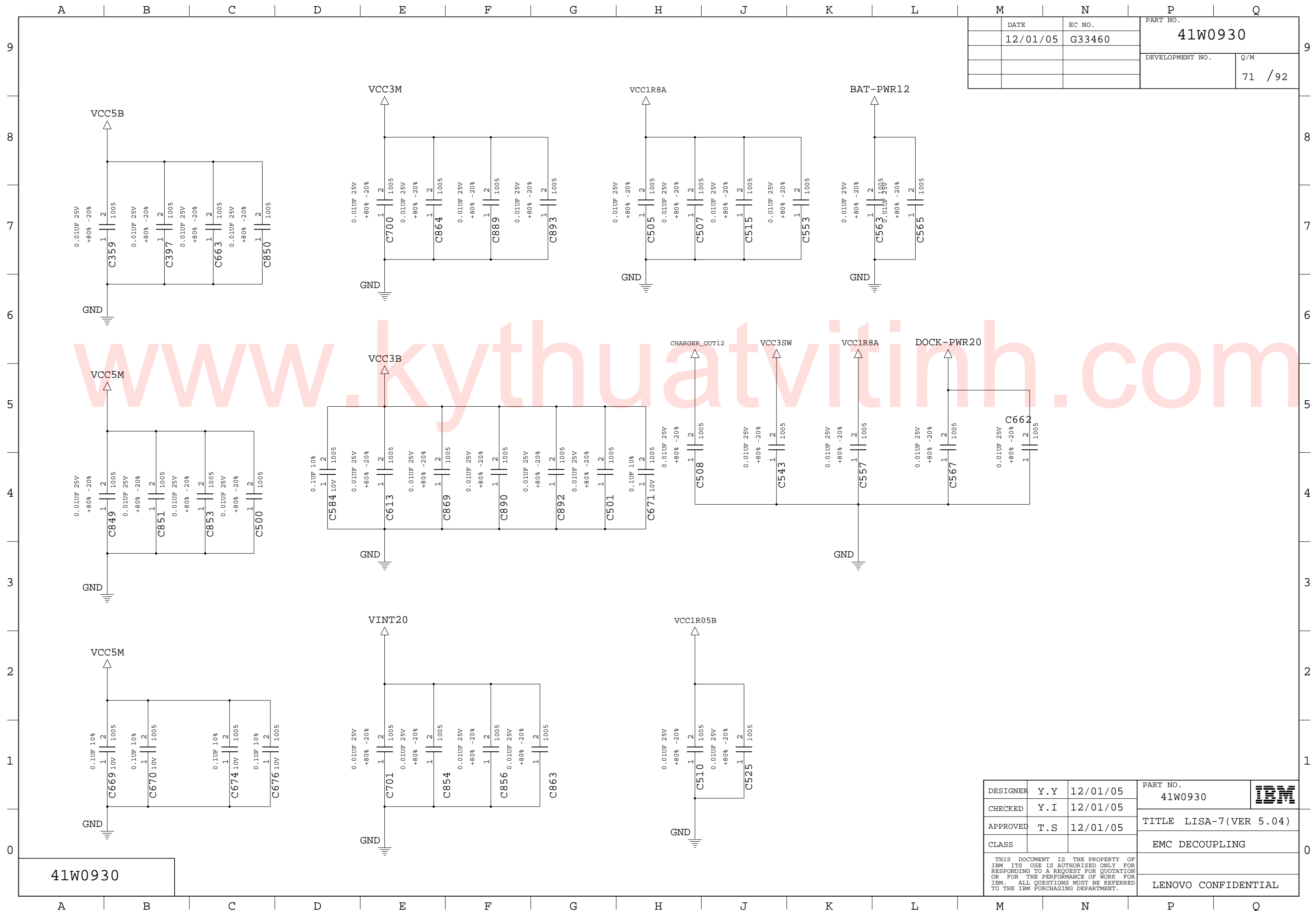

DATE	EC NO.	PART NO.	
12/01/05	G33460	41W0930	
		DEVELOPMENT NO.	Q/M
			71 / 92

41W0930

DESIGNER	Y.Y	12/01/05	PART NO.	41W0930	
CHECKED	Y.I	12/01/05	TITLE		
APPROVED	T.S	12/01/05	EMC DECOUPLING		
CLASS			LENOVO CONFIDENTIAL		
<small>THIS DOCUMENT IS THE PROPERTY OF IBM. ITS USE IS AUTHORIZED ONLY FOR RESPONDING TO A REQUEST FOR QUOTATION OR FOR THE PERFORMANCE OF WORK FOR IBM. ALL QUESTIONS MUST BE REFERRED TO THE IBM PURCHASING DEPARTMENT.</small>					

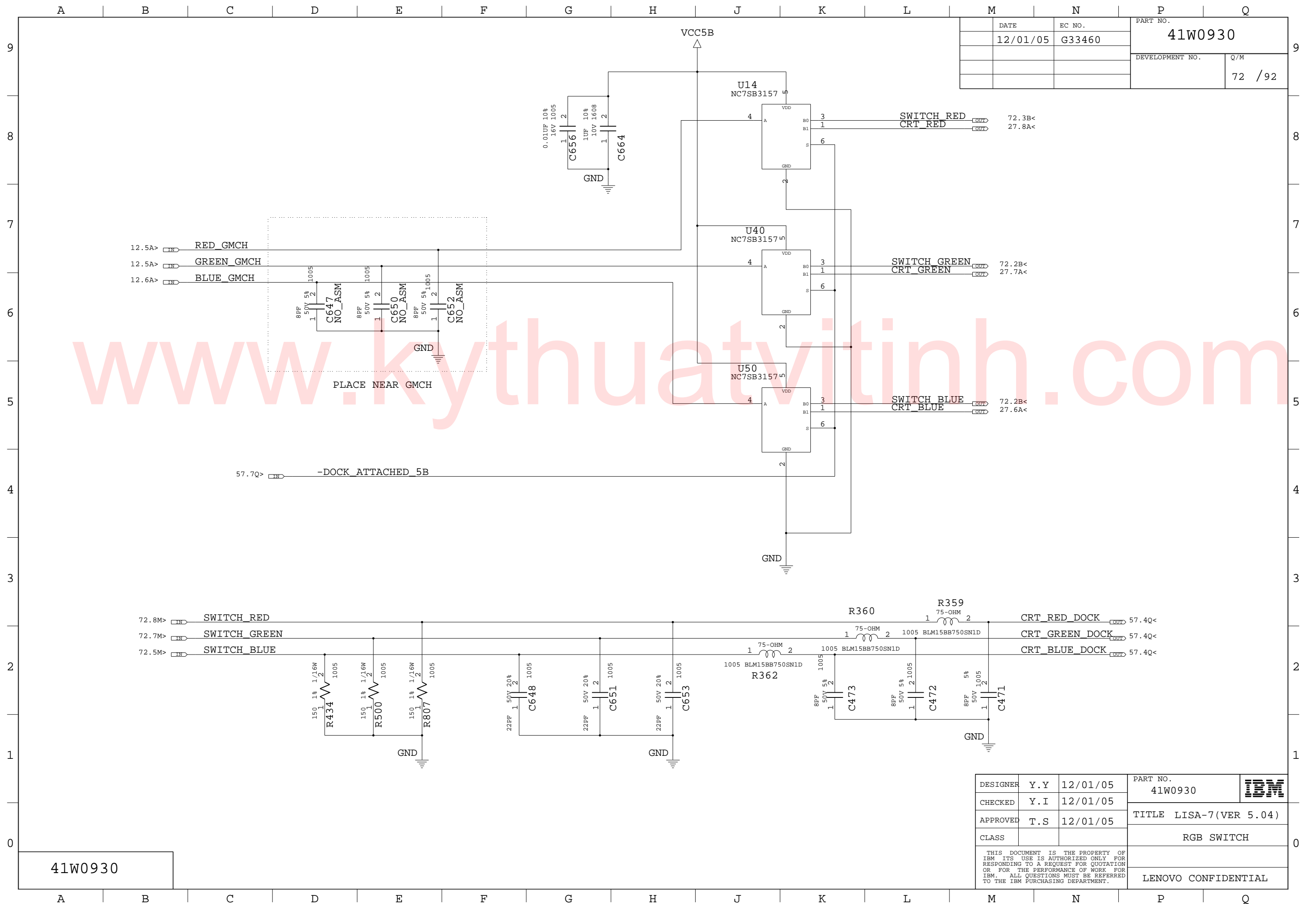

DATE	12/01/05	EC NO.	G33460	PART NO.	41W0930
				DEVELOPMENT NO.	Q/M
				72 / 92	

41W0930

DESIGNER	Y.Y	12/01/05	PART NO.	41W0930	
CHECKED	Y.I	12/01/05	TITLE LISA-7(VER 5.04)		
APPROVED	T.S	12/01/05	CLASS		RGB SWITCH
THIS DOCUMENT IS THE PROPERTY OF IBM ITS USE IS AUTHORIZED ONLY FOR RESPONDING TO A REQUEST FOR QUOTATION OR FOR THE PERFORMANCE OF WORK FOR IBM. ALL QUESTIONS MUST BE REFERRED TO THE IBM PURCHASING DEPARTMENT.					LENOVO CONFIDENTIAL

DATE	12/01/05	EC NO.	G33460	PART NO.	41W0930
DEVELOPMENT NO.		Q/M	73 / 92		

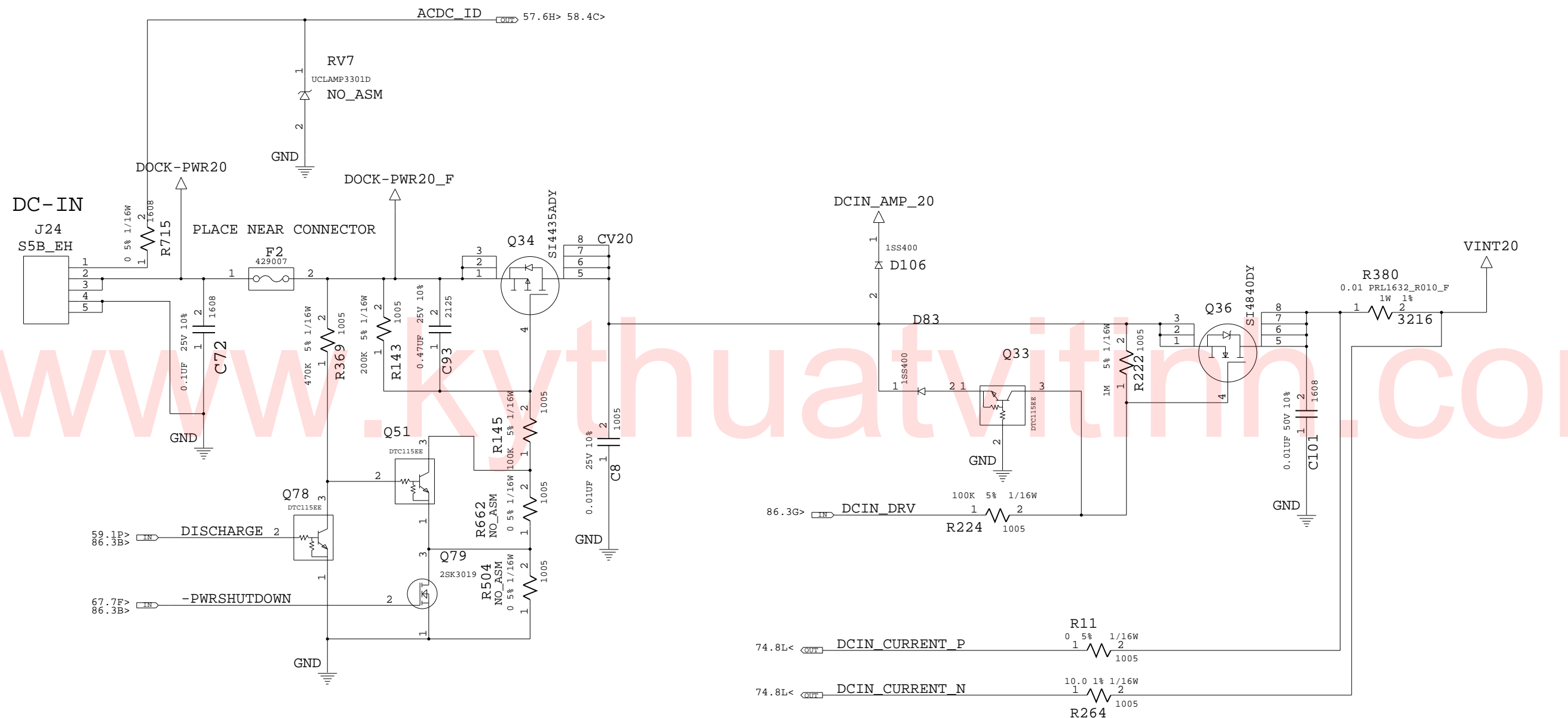

PEAK SHIFT	YES	NO
R504	NO-ASM	ASM
R369	ASM	NO-ASM
Q78	ASM	NO-ASM
Q79	ASM	NO-ASM

41W0930

DESIGNER	Y.Y	12/01/05	PART NO.	41W0930	
CHECKED	Y.I	12/01/05	TITLE	LISA-7(VER 5.04)	
APPROVED	T.S	12/01/05	CLASS	DC-IN	
THIS DOCUMENT IS THE PROPERTY OF IBM ITS USE IS AUTHORIZED ONLY FOR RESPONDING TO A REQUEST FOR QUOTATION OR FOR THE PERFORMANCE OF WORK FOR IBM. ALL QUESTIONS MUST BE REFERRED TO THE IBM PURCHASING DEPARTMENT.					LENOVO CONFIDENTIAL

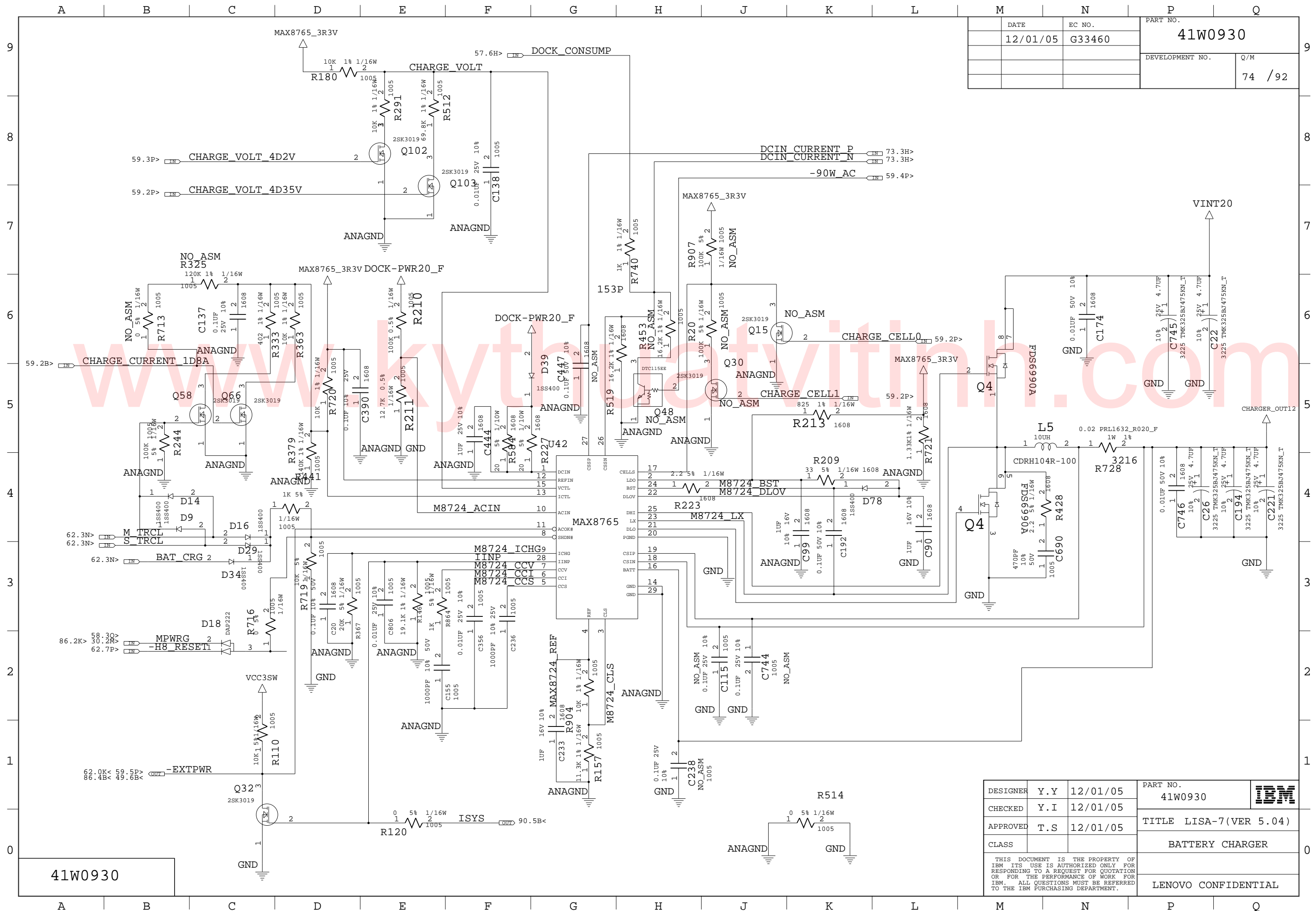

DATE	EC NO.	PART NO.
12/01/05	G33460	41W0930
DEVELOPMENT NO.		Q/M
		74 / 92

41W0930

DESIGNER	Y.Y	12/01/05	PART NO.	41W0930	
CHECKED	Y.I	12/01/05	TITLE LISA-7(VER 5.04)		
APPROVED	T.S	12/01/05	BATTERY CHARGER		
CLASS			LENOVO CONFIDENTIAL		

THIS DOCUMENT IS THE PROPERTY OF IBM ITS USE IS AUTHORIZED ONLY FOR RESPONDING TO A REQUEST FOR QUOTATION OR FOR THE PERFORMANCE OF WORK FOR IBM. ALL QUESTIONS MUST BE REFERRED TO THE IBM PURCHASING DEPARTMENT.

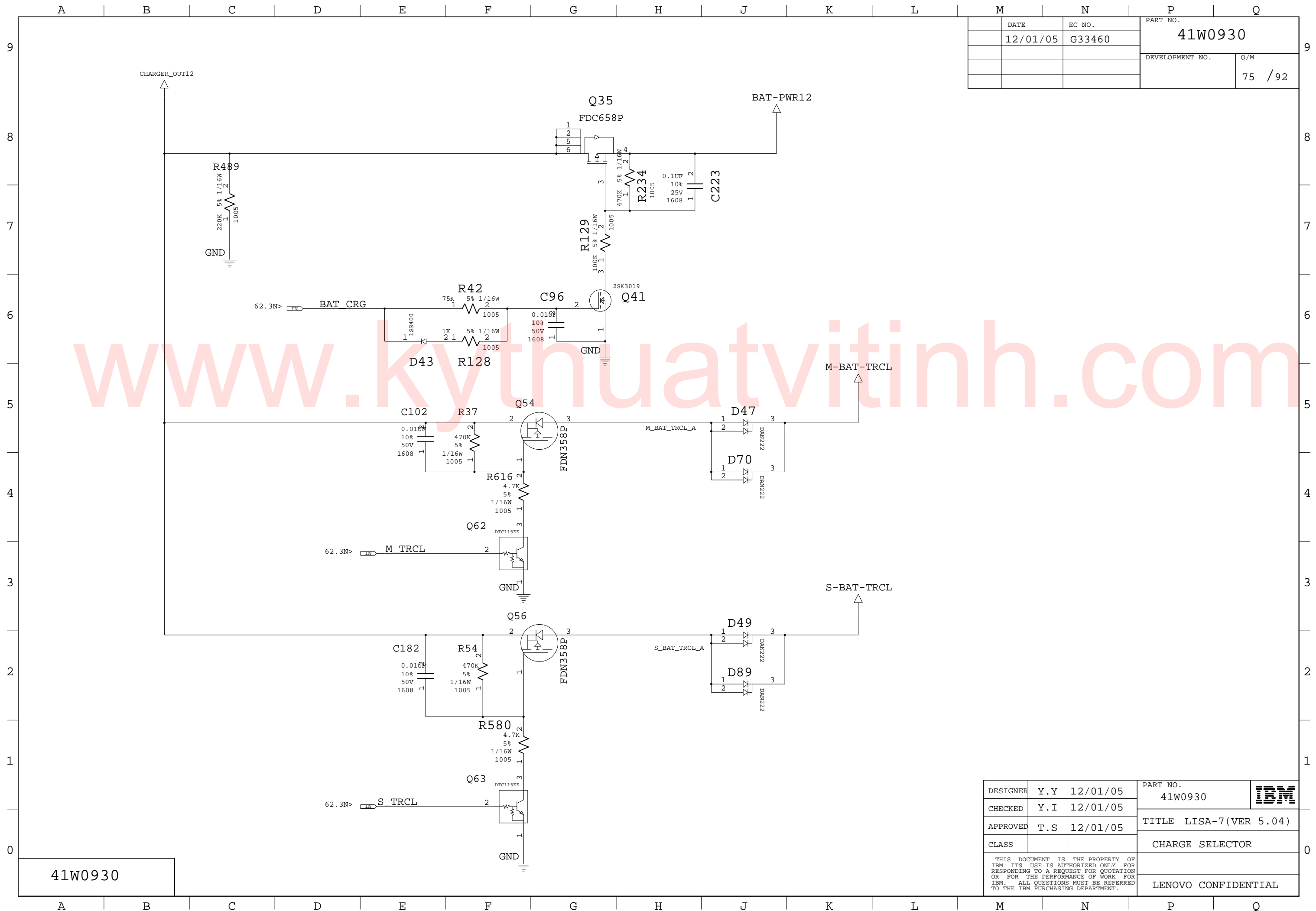

DATE	EC NO.	PART NO.	
12/01/05	G33460	41W0930	
		DEVELOPMENT NO.	Q/M
			75 / 92

41W0930

DESIGNER	Y.Y	12/01/05	PART NO.	41W0930	
CHECKED	Y.I	12/01/05			
APPROVED	T.S	12/01/05	TITLE LISA-7(VER 5.04)		
CLASS			CHARGE SELECTOR		
THIS DOCUMENT IS THE PROPERTY OF IBM ITS USE IS AUTHORIZED ONLY FOR RESPONDING TO A REQUEST FOR QUOTATION OR FOR THE PERFORMANCE OF WORK FOR IBM. ALL QUESTIONS MUST BE REFERRED TO THE IBM PURCHASING DEPARTMENT.					LENOVO CONFIDENTIAL

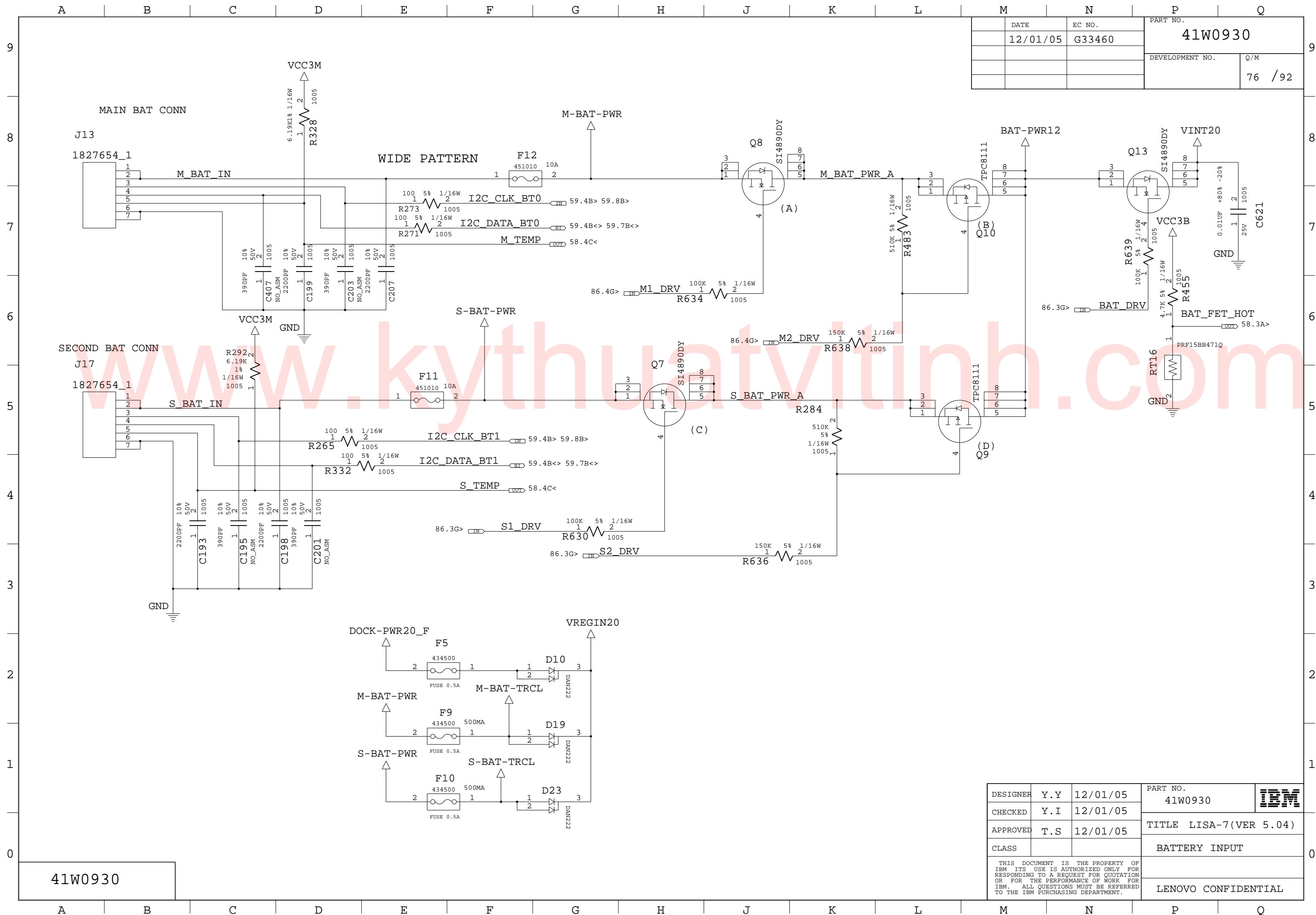

DATE	EC NO.	PART NO.
12/01/05	G33460	41W0930
DEVELOPMENT NO.		Q/M
		76 / 92

DESIGNER	Y.Y	12/01/05	PART NO.	41W0930	IBM
CHECKED	Y.I	12/01/05	TITLE LISA-7(VER 5.04)		
APPROVED	T.S	12/01/05	BATTERY INPUT		
CLASS			LENOVO CONFIDENTIAL		
<small>THIS DOCUMENT IS THE PROPERTY OF IBM ITS USE IS AUTHORIZED ONLY FOR RESPONDING TO A REQUEST FOR QUOTATION OR FOR THE PERFORMANCE OF WORK FOR IBM. ALL QUESTIONS MUST BE REFERRED TO THE IBM PURCHASING DEPARTMENT.</small>					

41W0930



	DATE	EC NO.	PART NO.	
	12/01/05	G33460	41W0930	
			DEVELOPMENT NO.	Q/M
				77 / 92

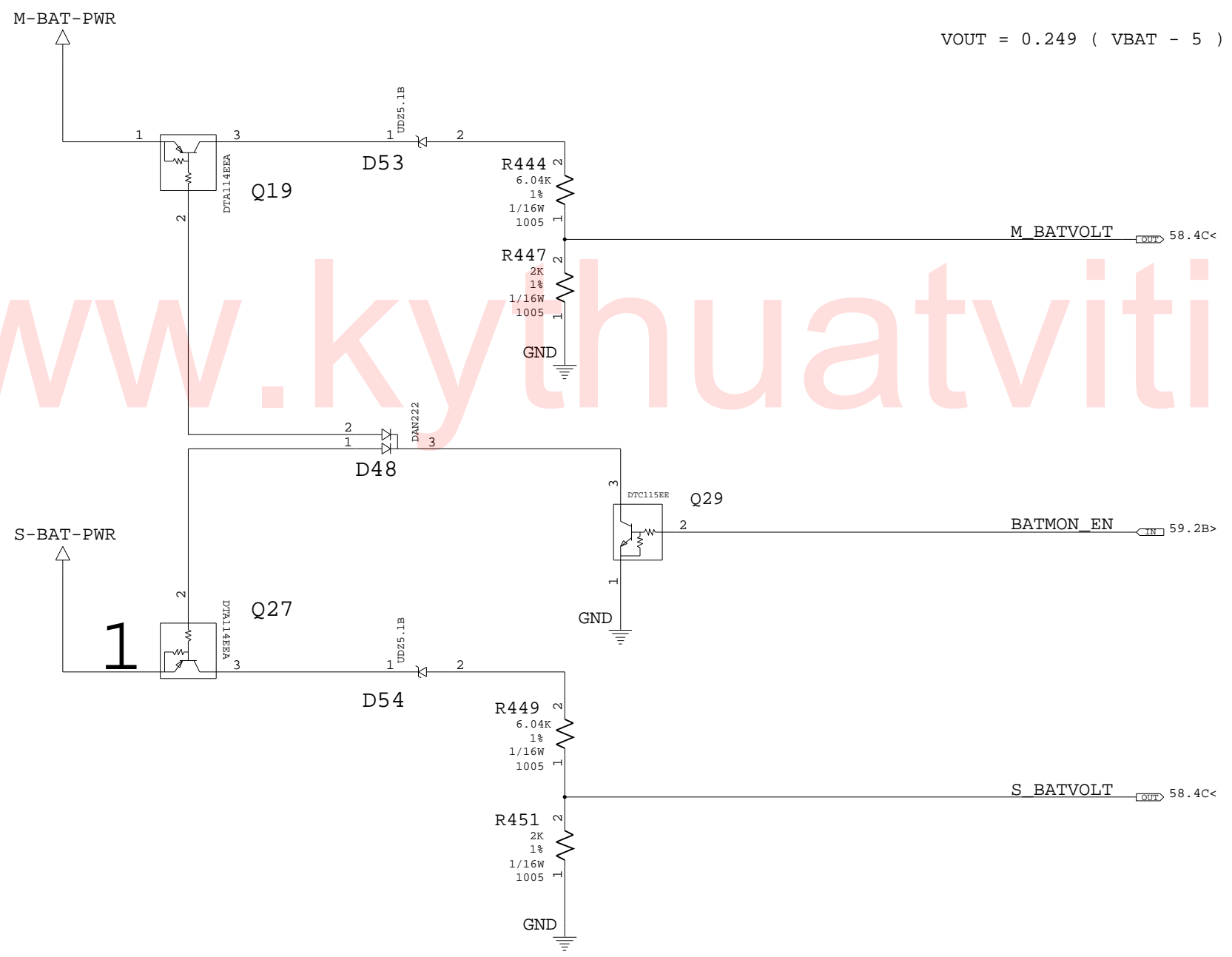

www.kyathuatvithinh.com

41W0930

DESIGNER	Y.Y	12/01/05	PART NO.	41W0930	<b>IBM</b>
CHECKED	Y.I	12/01/05			
APPROVED	T.S	12/01/05	TITLE LISA-7(VER 5.04)		
CLASS			BATTERY MONITOR		
THIS DOCUMENT IS THE PROPERTY OF IBM ITS USE IS AUTHORIZED ONLY FOR RESPONDING TO A REQUEST FOR QUOTATION OR FOR THE PERFORMANCE OF WORK FOR IBM. ALL QUESTIONS MUST BE REFERRED TO THE IBM PURCHASING DEPARTMENT.				LENOVO CONFIDENTIAL	

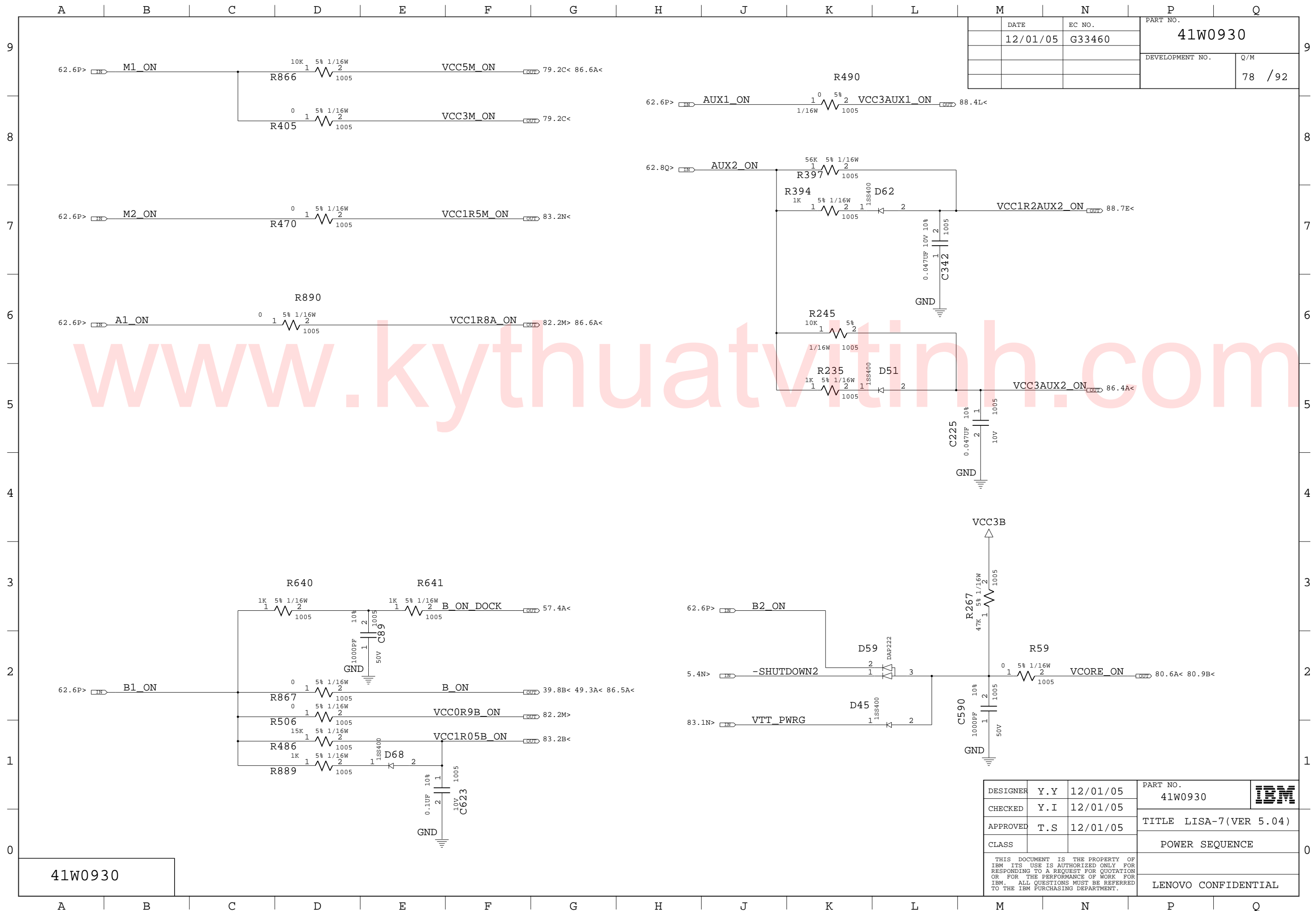

DATE	12/01/05	EC NO.	G33460	PART NO.	41W0930
DEVELOPMENT NO.				Q/M	78 / 92

41W0930

DESIGNER	Y.Y	12/01/05	PART NO.	41W0930	<b>IBM</b>
CHECKED	Y.I	12/01/05	TITLE LISA-7(VER 5.04)		
APPROVED	T.S	12/01/05	POWER SEQUENCE		
THIS DOCUMENT IS THE PROPERTY OF IBM. ITS USE IS AUTHORIZED ONLY FOR RESPONDING TO A REQUEST FOR QUOTATION OR FOR THE PERFORMANCE OF WORK FOR IBM. ALL QUESTIONS MUST BE REFERRED TO THE IBM PURCHASING DEPARTMENT.					LENOVO CONFIDENTIAL

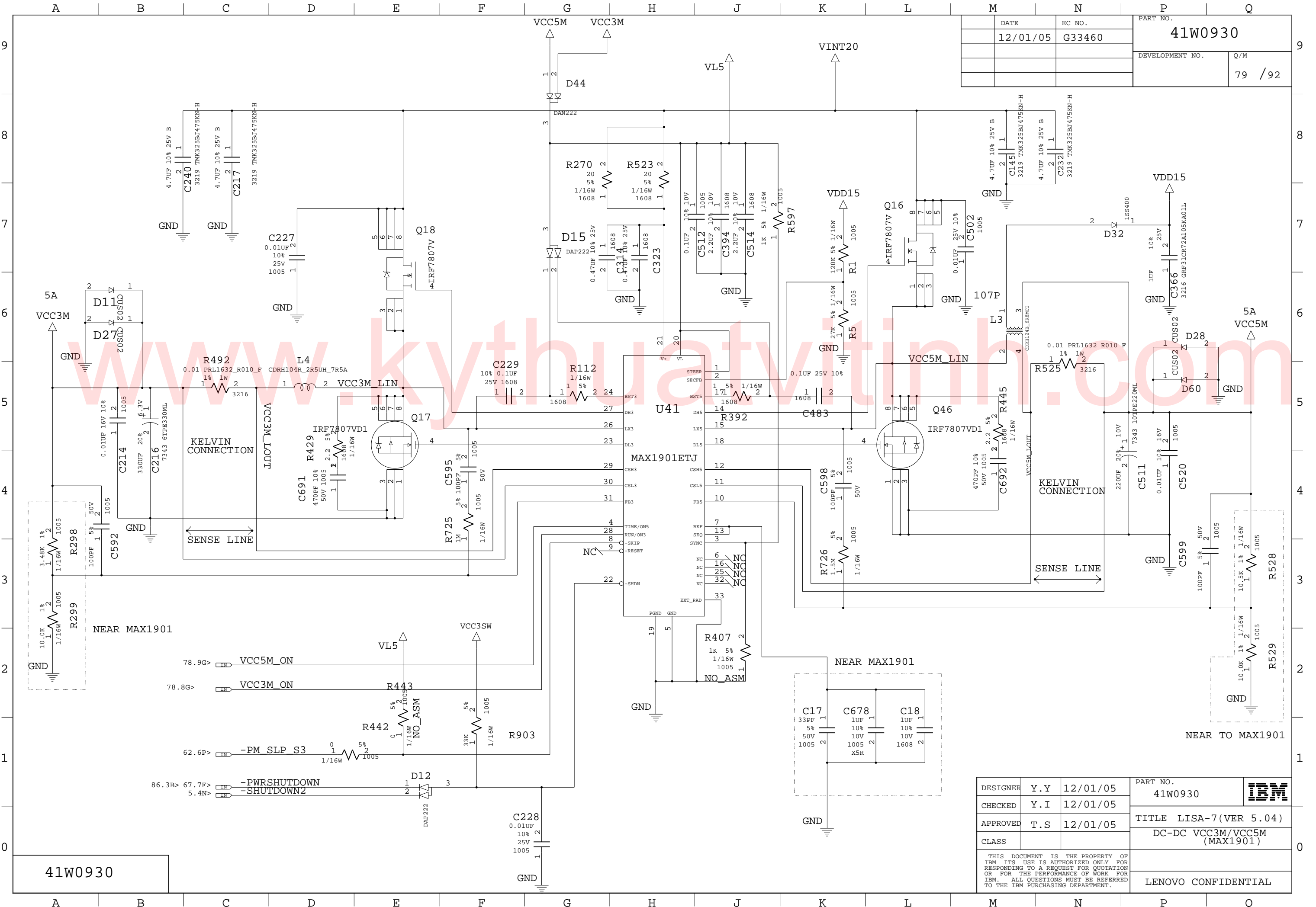

DATE	EC NO.	PART NO.
12/01/05	G33460	41W0930
DEVELOPMENT NO.		Q/M
		79 / 92

DESIGNER	Y.Y	12/01/05	PART NO.	41W0930	
CHECKED	Y.I	12/01/05	TITLE LISA-7(VER 5.04)		
APPROVED	T.S	12/01/05	DC-DC VCC3M/VCC5M (MAX1901)		
CLASS					
THIS DOCUMENT IS THE PROPERTY OF IBM ITS USE IS AUTHORIZED ONLY FOR RESPONDING TO A REQUEST FOR QUOTATION OR FOR THE PERFORMANCE OF WORK FOR IBM. ALL QUESTIONS MUST BE REFERRED TO THE IBM PURCHASING DEPARTMENT.					LENOVO CONFIDENTIAL

41W0930



A B C D E F G H J K L M N P Q

DATE	EC NO.	PART NO.	
12/01/05	G33460	41W0930	
		DEVELOPMENT NO.	Q/M
			81 /92

9  
8  
7  
6  
5  
4  
3  
2  
1  
0

FOLLOWING 7 PCS OF 0.47UF AREA ASM FOR VCCCPUCORE TO REDUCE EMI.

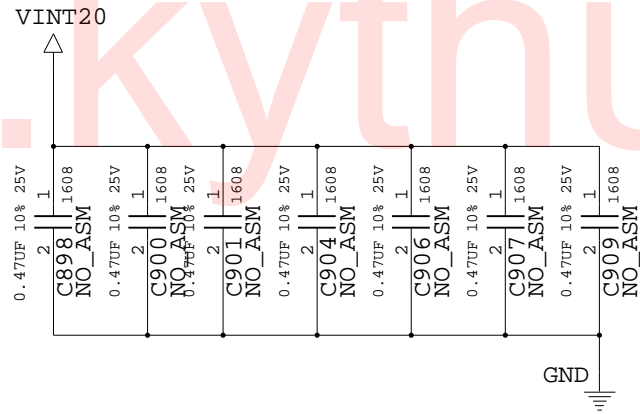

www.kythuatvitinh.com

41W0930

DESIGNER	Y.Y	12/01/05	PART NO.	41W0930	
CHECKED	Y.I	12/01/05			
APPROVED	T.S	12/01/05	TITLE LISA-7(VER 5.04)		
CLASS			DC-DC VCORE INPUT CAP		
THIS DOCUMENT IS THE PROPERTY OF IBM ITS USE IS AUTHORIZED ONLY FOR RESPONDING TO A REQUEST FOR QUOTATION OR FOR THE PERFORMANCE OF WORK FOR IBM. ALL QUESTIONS MUST BE REFERRED TO THE IBM PURCHASING DEPARTMENT.					LENOVO CONFIDENTIAL

A B C D E F G H J K L M N P Q

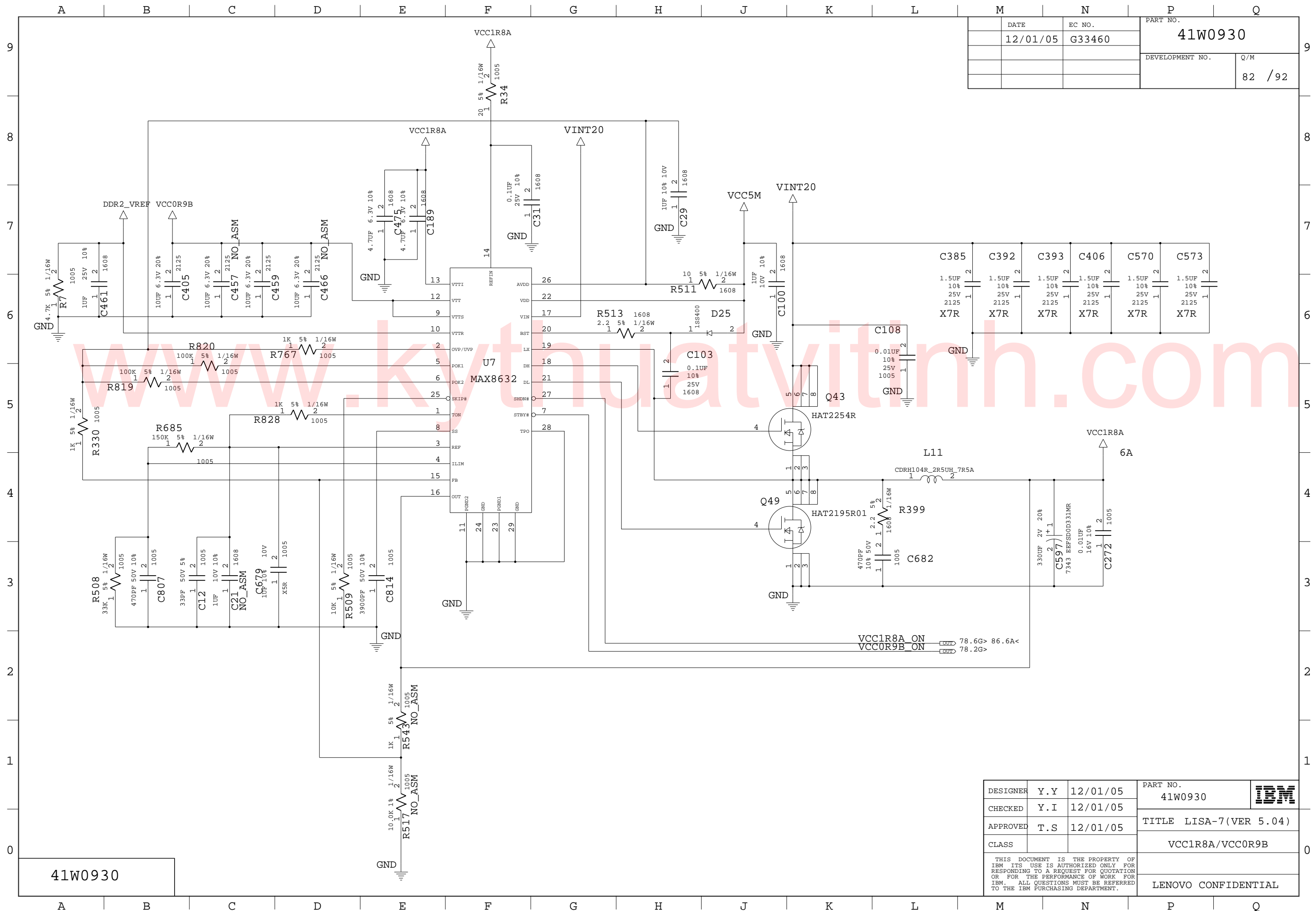

DATE	12/01/05	EC NO.	G33460	PART NO.	41W0930
DEVELOPMENT NO.		Q/M	82 / 92		

41W0930

DESIGNER	Y.Y	12/01/05	PART NO.	41W0930	
CHECKED	Y.I	12/01/05	TITLE	LISA-7(VER 5.04)	
APPROVED	T.S	12/01/05		VCC1R8A/VCC0R9B	
CLASS			THIS DOCUMENT IS THE PROPERTY OF IBM. ITS USE IS AUTHORIZED ONLY FOR RESPONDING TO A REQUEST FOR QUOTATION OR FOR THE PERFORMANCE OF WORK FOR IBM. ALL QUESTIONS MUST BE REFERRED TO THE IBM PURCHASING DEPARTMENT.		
				LENOVO CONFIDENTIAL	



DATE	EC NO.	PART NO.	
12/01/05	G33460	41W0930	
		DEVELOPMENT NO.	Q/M
			83 / 92

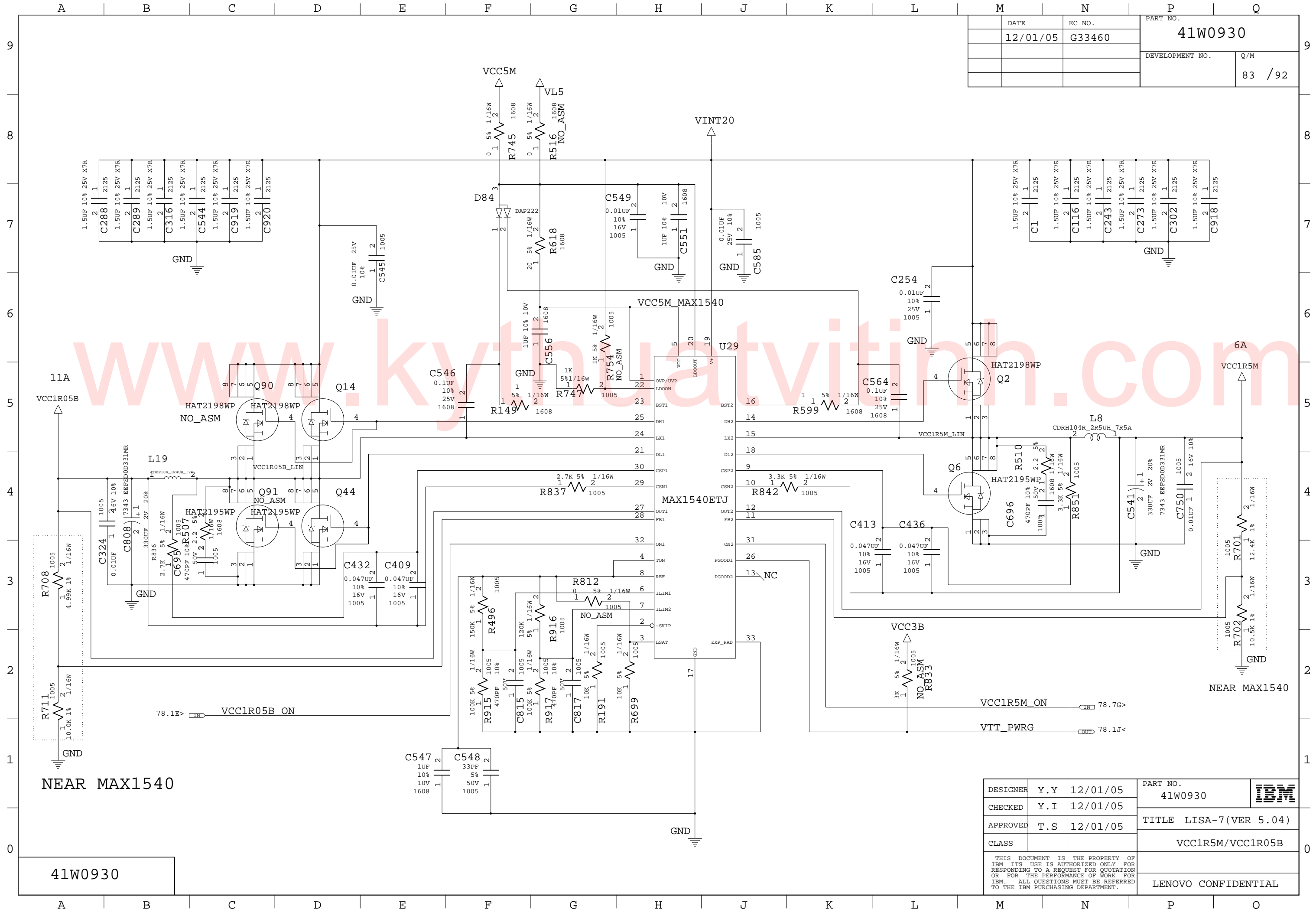

DESIGNER	Y.Y	12/01/05	PART NO.	41W0930	
CHECKED	Y.I	12/01/05			
APPROVED	T.S	12/01/05	TITLE	LISA-7(VER 5.04)	
CLASS				VCC1R5M/VCC1R05B	
THIS DOCUMENT IS THE PROPERTY OF IBM ITS USE IS AUTHORIZED ONLY FOR RESPONDING TO A REQUEST FOR QUOTATION OR FOR THE PERFORMANCE OF WORK FOR IBM. ALL QUESTIONS MUST BE REFERRED TO THE IBM PURCHASING DEPARTMENT.				LENOVO CONFIDENTIAL	

41W0930



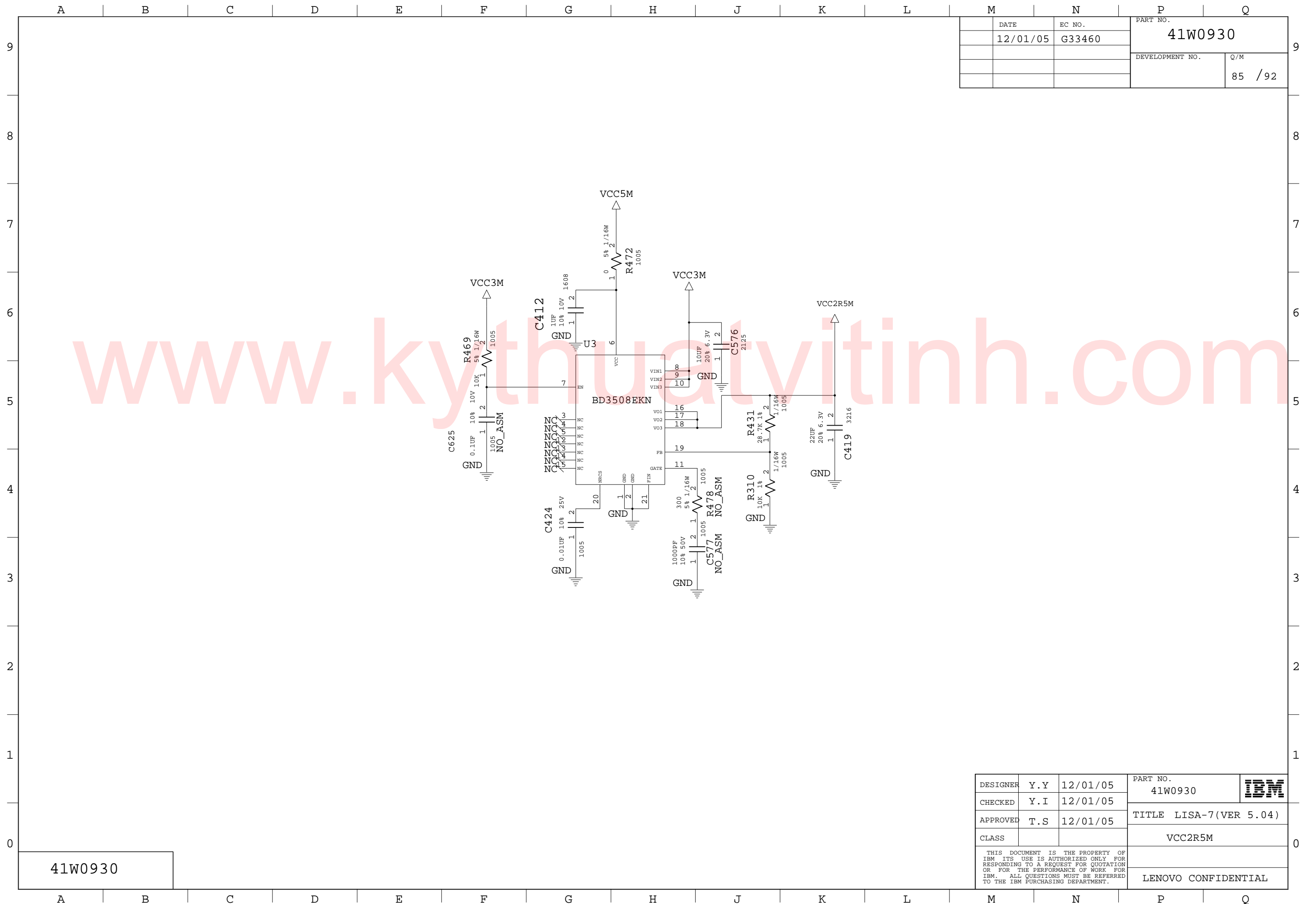

DATE	EC NO.	PART NO.	
12/01/05	G33460	41W0930	
		DEVELOPMENT NO.	Q/M
			85 / 92

41W0930

DESIGNER	Y.Y	12/01/05	PART NO.	41W0930	
CHECKED	Y.I	12/01/05			
APPROVED	T.S	12/01/05	TITLE LISA-7(VER 5.04)		
CLASS			VCC2R5M		
THIS DOCUMENT IS THE PROPERTY OF IBM ITS USE IS AUTHORIZED ONLY FOR RESPONDING TO A REQUEST FOR QUOTATION OR FOR THE PERFORMANCE OF WORK FOR IBM. ALL QUESTIONS MUST BE REFERRED TO THE IBM PURCHASING DEPARTMENT.					L
					LENOVO CONFIDENTIAL

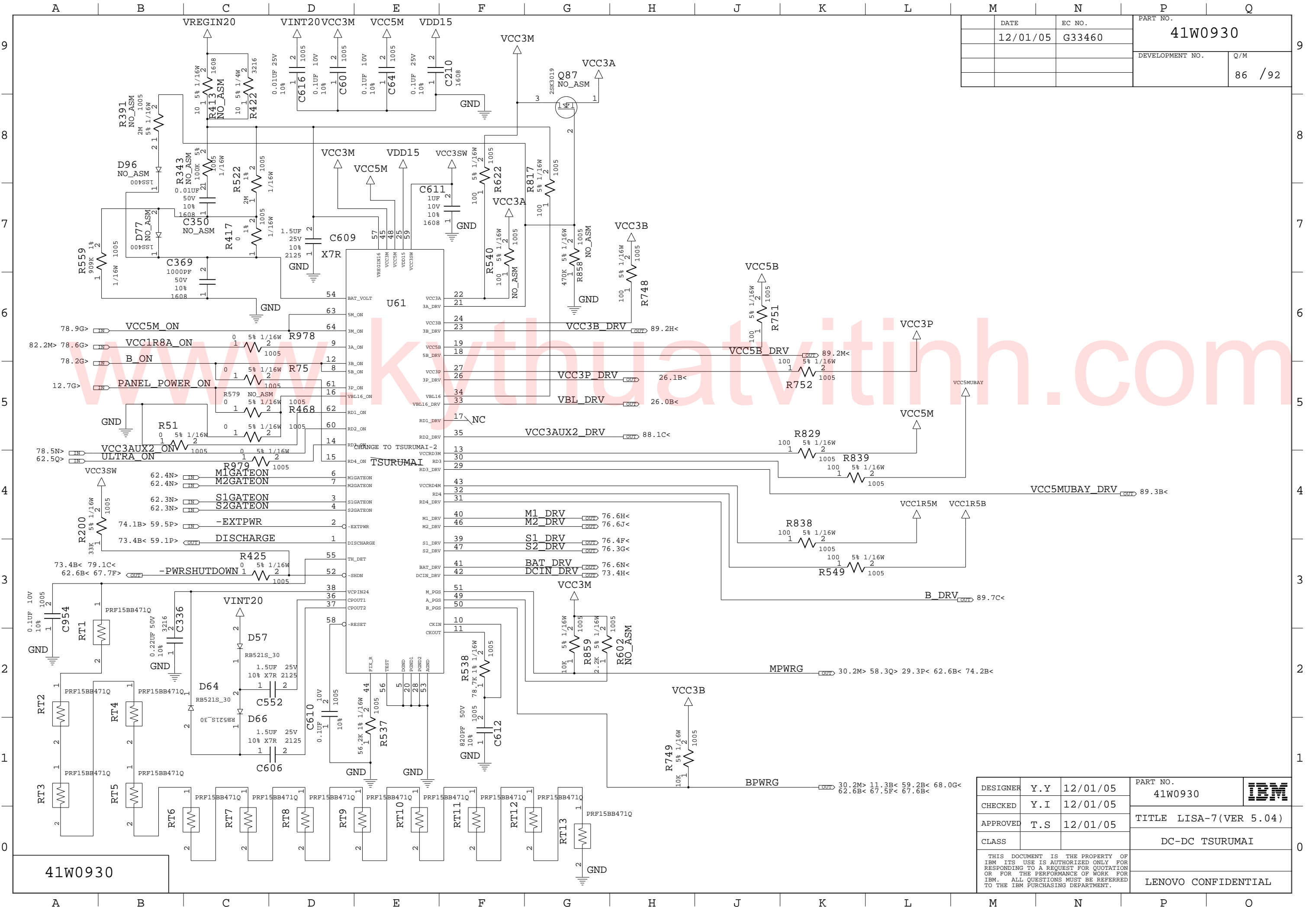

DATE	12/01/05	EC NO.	G33460	PART NO.	41W0930
DEVELOPMENT NO.		Q/M	86 / 92		

41W0930

DESIGNER	Y.Y	12/01/05	PART NO.	41W0930	
CHECKED	Y.I	12/01/05	TITLE	LISA-7(VER 5.04)	
APPROVED	T.S	12/01/05		DC-DC TSURUMAI	
CLASS					
THIS DOCUMENT IS THE PROPERTY OF IBM ITS USE IS AUTHORIZED ONLY FOR RESPONDING TO A REQUEST FOR QUOTATION OR FOR THE PERFORMANCE OF WORK FOR IBM. ALL QUESTIONS MUST BE REFERRED TO THE IBM PURCHASING DEPARTMENT.					LENOVO CONFIDENTIAL



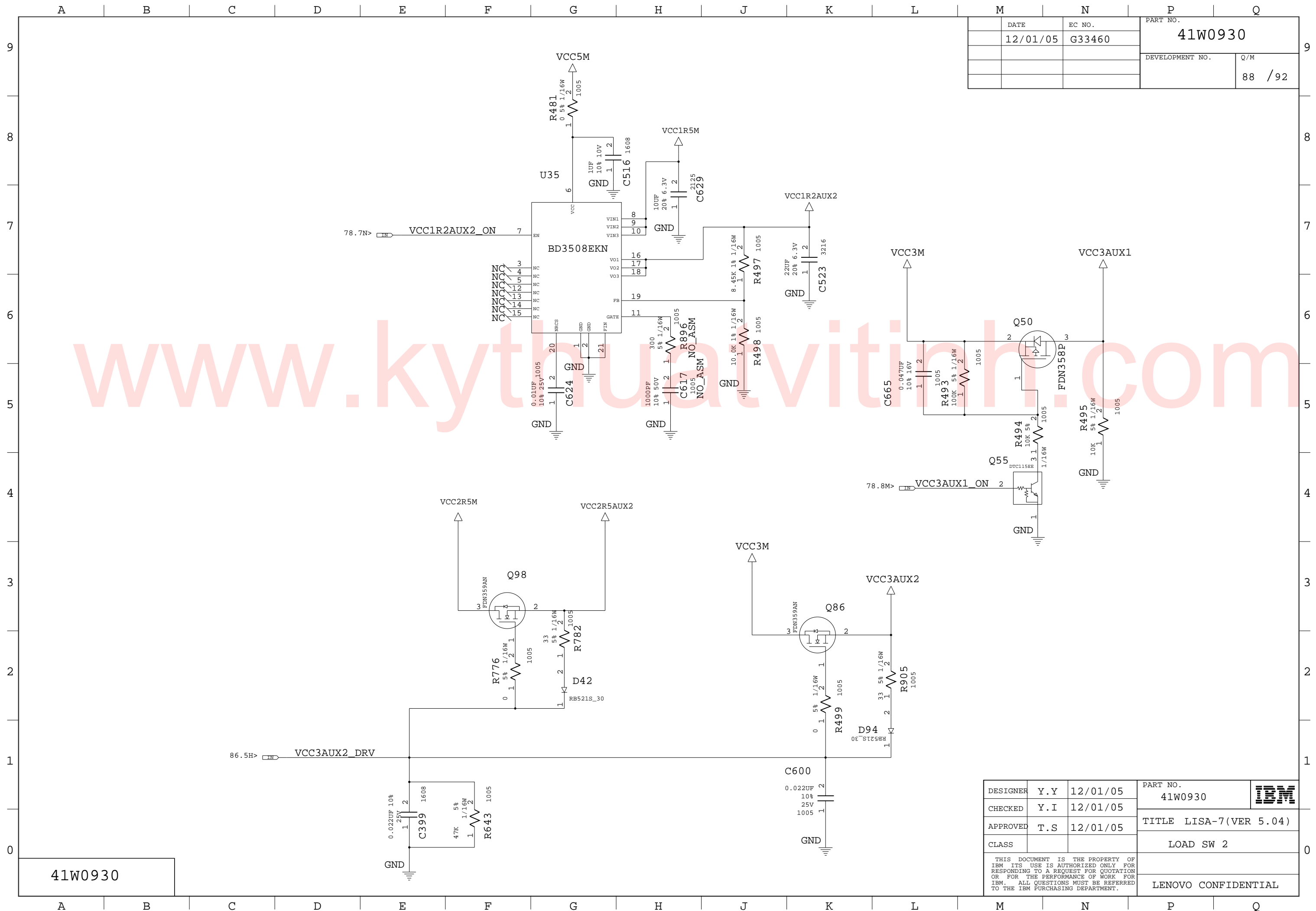

DATE	EC NO.	PART NO.	
12/01/05	G33460	41W0930	
		DEVELOPMENT NO.	Q/M
			88 / 92

41W0930

DESIGNER	Y.Y	12/01/05	PART NO.	41W0930	IBM
CHECKED	Y.I	12/01/05	TITLE		
APPROVED	T.S	12/01/05		LOAD SW 2	
CLASS					
THIS DOCUMENT IS THE PROPERTY OF IBM. ITS USE IS AUTHORIZED ONLY FOR RESPONDING TO A REQUEST FOR QUOTATION OR FOR THE PERFORMANCE OF WORK FOR IBM. ALL QUESTIONS MUST BE REFERRED TO THE IBM PURCHASING DEPARTMENT.					LENOVO CONFIDENTIAL



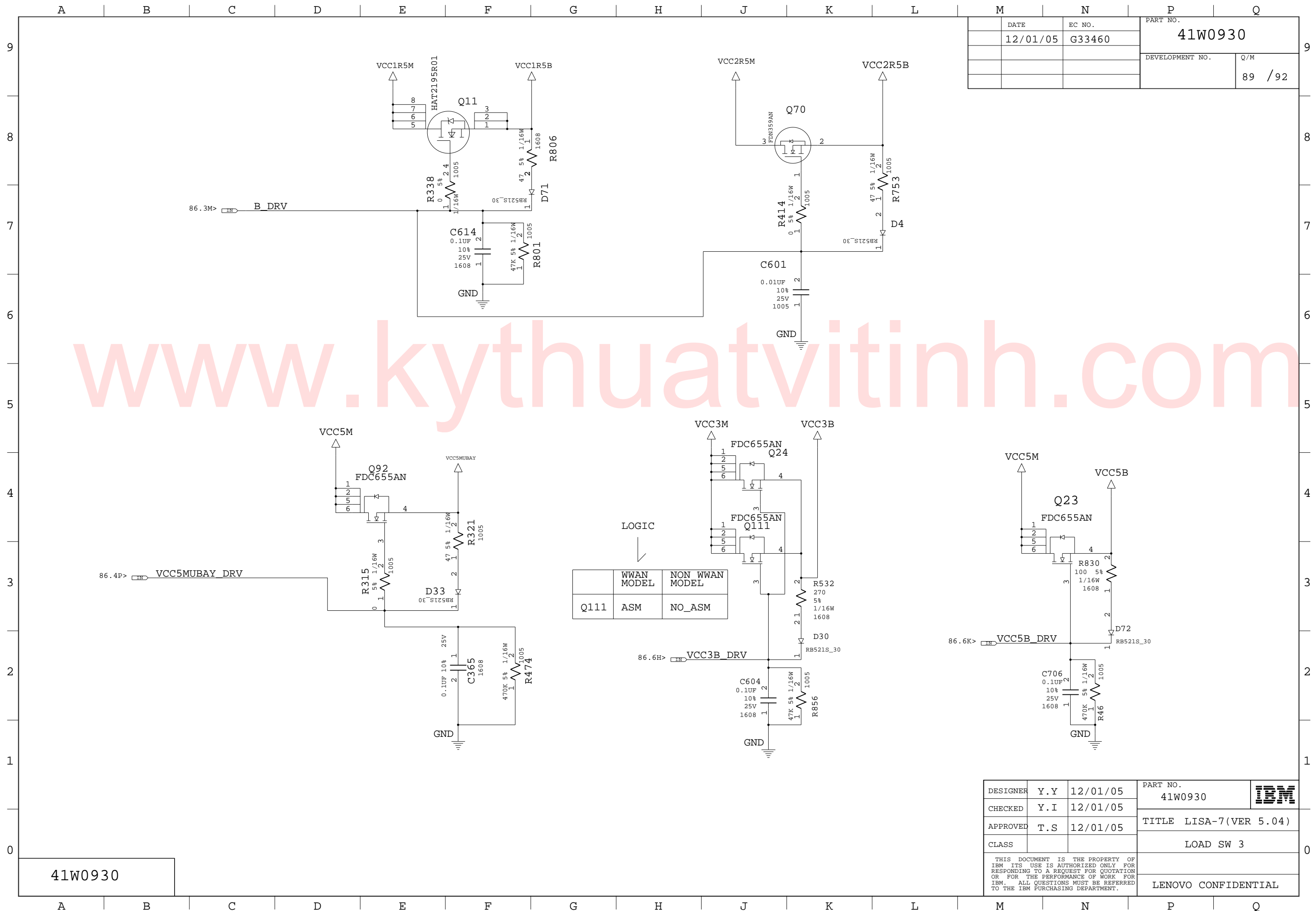

DATE	EC NO.	PART NO.	
12/01/05	G33460	41W0930	
		DEVELOPMENT NO.	Q/M
			89 / 92

41W0930

DESIGNER	Y.Y	12/01/05	PART NO.	41W0930	<b>IBM</b>
CHECKED	Y.I	12/01/05	TITLE LISA-7(VER 5.04)		
APPROVED	T.S	12/01/05	LOAD SW 3		
CLASS					
THIS DOCUMENT IS THE PROPERTY OF IBM ITS USE IS AUTHORIZED ONLY FOR RESPONDING TO A REQUEST FOR QUOTATION OR FOR THE PERFORMANCE OF WORK FOR IBM. ALL QUESTIONS MUST BE REFERRED TO THE IBM PURCHASING DEPARTMENT.					LENOVO CONFIDENTIAL

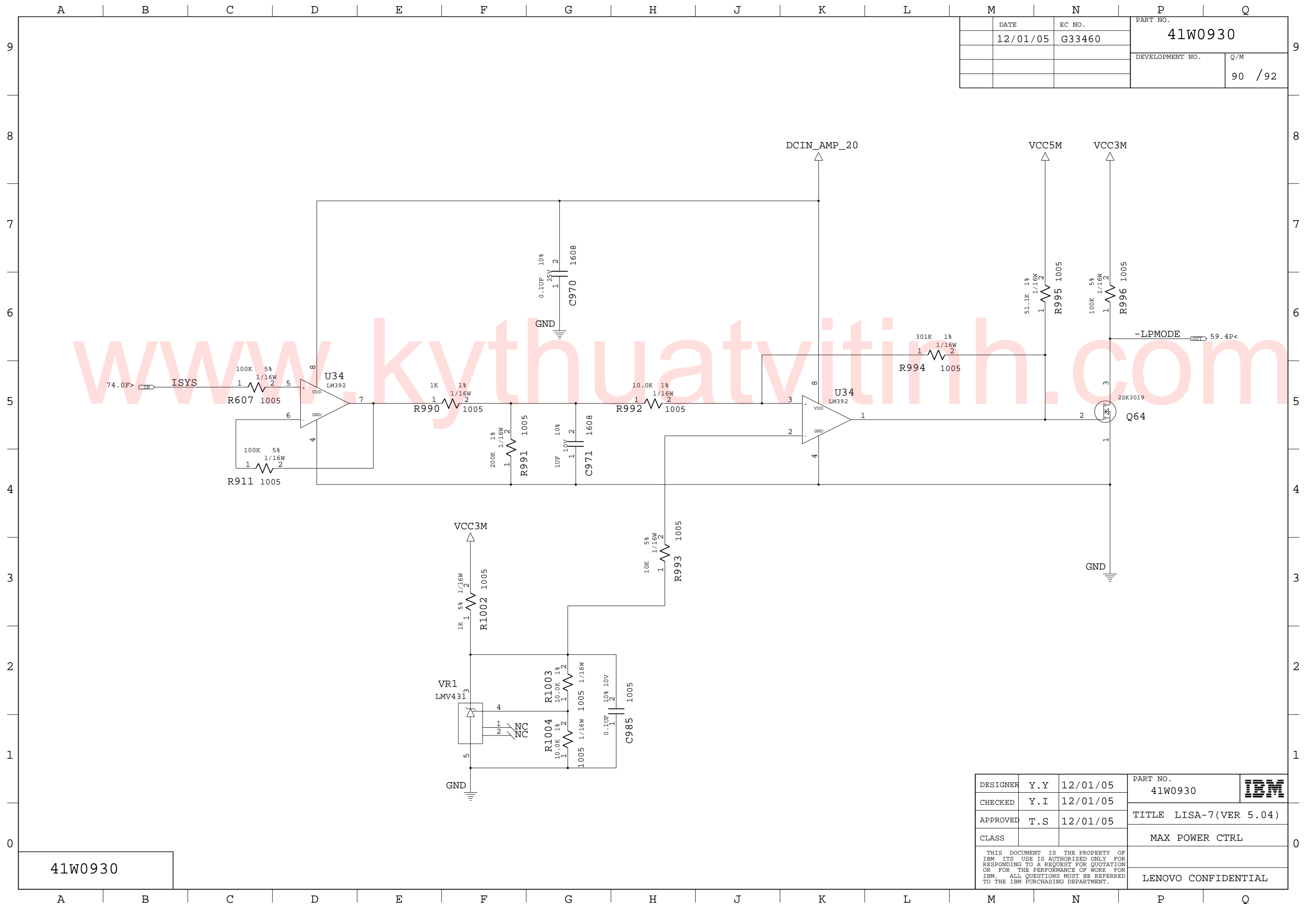

DATE	EC NO.	PART NO.	
12/01/05	G33460	41W0930	
		DEVELOPMENT NO.	Q/M
			90 / 92

41W0930

DESIGNER	Y.Y	12/01/05	PART NO.	41W0930	
CHECKED	Y.I	12/01/05			
APPROVED	T.S	12/01/05	TITLE LISA-7(VER 5.04)		
CLASS			MAX POWER CTRL		
THIS DOCUMENT IS THE PROPERTY OF IBM ITS USE IS AUTHORIZED ONLY FOR RESPONDING TO A REQUEST FOR QUOTATION OR FOR THE PERFORMANCE OF WORK FOR IBM. ALL QUESTIONS MUST BE REFERRED TO THE IBM PURCHASING DEPARTMENT.					LENOVO CONFIDENTIAL



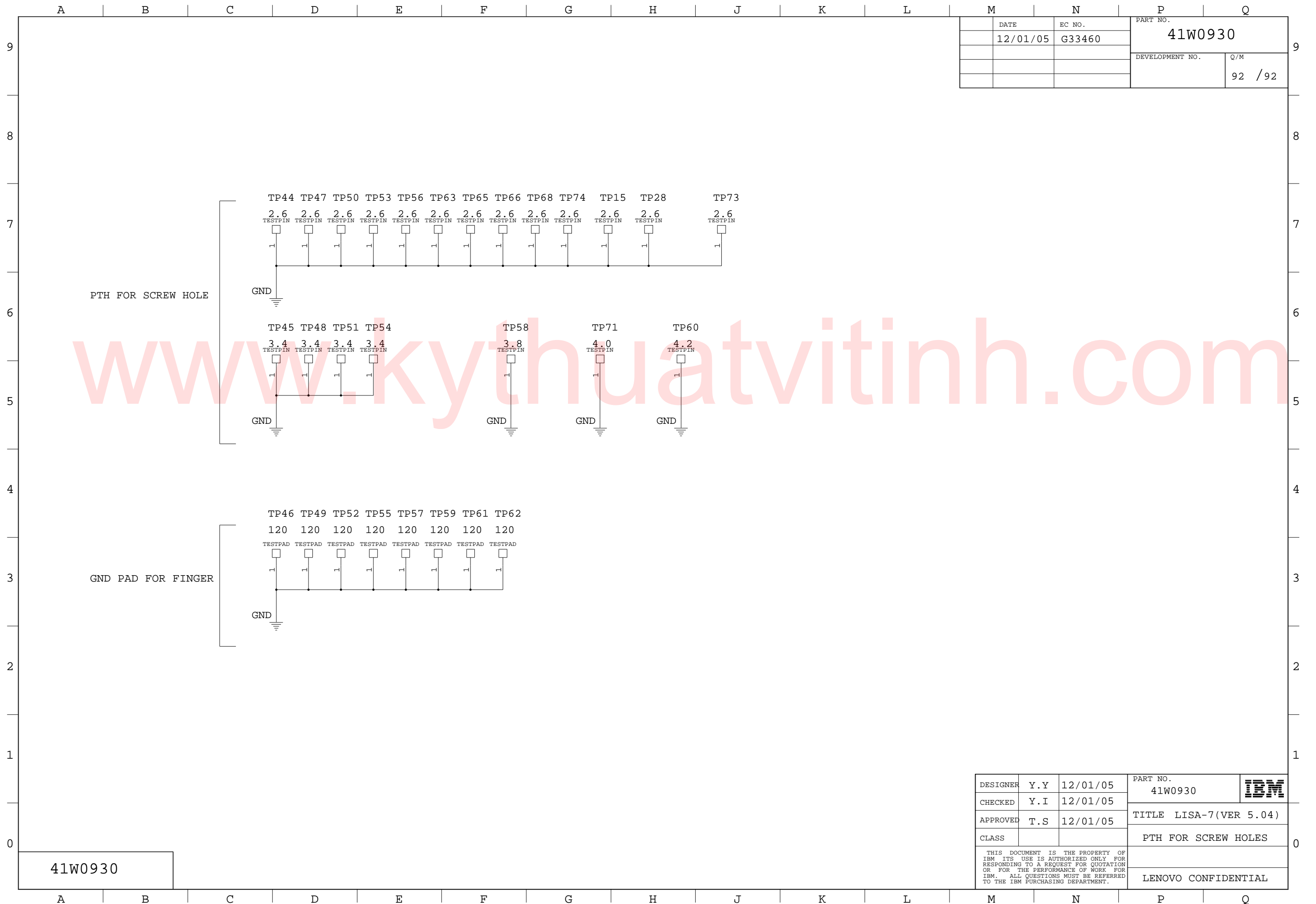

DATE	EC NO.	PART NO.	
12/01/05	G33460	41W0930	
		DEVELOPMENT NO.	Q/M
			92 / 92

41W0930

DESIGNER	Y.Y	12/01/05	PART NO.	41W0930	<b>IBM</b>
CHECKED	Y.I	12/01/05			
APPROVED	T.S	12/01/05	TITLE LISA-7(VER 5.04)		
CLASS			PTH FOR SCREW HOLES		
THIS DOCUMENT IS THE PROPERTY OF IBM ITS USE IS AUTHORIZED ONLY FOR RESPONDING TO A REQUEST FOR QUOTATION OR FOR THE PERFORMANCE OF WORK FOR IBM. ALL QUESTIONS MUST BE REFERRED TO THE IBM PURCHASING DEPARTMENT.				LENOVO CONFIDENTIAL	