

LISA-7 FOR SVT

(DAVINCI-1 INTEG GFX)

DATE	EC NO.	PART NO.
12/01/05	G33460	41W0930
		DEVELOPMENT NO.
		Q/M
		1 /92

VER 5.04

DEC/01/2005

- | | |
|--|--|
| <ol style="list-style-type: none"> 1. TITLE PAGE 2. EC HISTORY 3. CPU(1/3) 4. CPU(2/3) 5. CPU(3/3) 6. ITP CON/LARGE PTH HOLE/EMI FINGER 7. VCCCPUCORE DECOUPLING 8. CALISTOGA(1/7) : HOST I/F 9. CALISTOGA(2/7) : DDR2-A 10. CALISTOGA(3/7) : DDR2-B 11. CALISTOGA(4/7) : PEG/DMI 12. CALISTOGA(5/7) : GRAPHICS 13. CALISTOGA(6/7) : VCC 14. CALISTOGA(7/7) : GND 15. DDR2 SODIMM-A 16. DDR2 SODIMM-B 17. DDR2 TERMINATION 18. DDR2 DECOUPLING 19. CLOCK GEN(ICS954309) 20. DVI TRANSMITTER 21. BLANK 22. BLANK 23. BLANK 24. BLANK 25. BLANK 26. LCD CONNECTOR 27. EXT CRT INTERFACE 28. PATA I/F PU 29. ICH7-M(1/4) : DMI/PCI/LPC/AC97 30. ICH7-M(2/4) : ATA/USB/PM 31. ICH7-M(3/4) : PCI EXPRESS 32. ICH7-M(4/4) : VCC/GND 33. FWH,RTC BATTERY 34. SATA HDD CONN 35. BAY I/F CONN 36. USB POWER/CONN 37. AUDIO AD1981HD 38. AUDIO MISC 39. AUDIO INT MIC 40. AUDIO HP & EXT MIC CONN 41. AUDIO EXT MIC AMP 42. AUDIO SPEAKER 43. AUDIO HDP AMP MAX9750 44. AUDIO HDP AMP MISC | <ol style="list-style-type: none"> 45. CDC CONNECTOR 46. CARDBUS CONTROLLER(1/2) 47. CARDBUS CONTROLLER(2/2) 48. CARDBUS/EXC SLOT 49. CARDBUS/EXC PWR CTRL 50. GBE LAN SW 51. GBE VIDALIA(1/2) 52. GBE VIDALIA(2/2) 53. GBE MAGNETICS 54. RJ11/RJ45 CONNECTOR 55. MINI-PCIE SLOT 56. EEPROM/FLASH/SHARED 57. DOCKING CONNECTOR 58. H8S/2116(1/2) 59. H8S/2116(2/2) 60. KEYBOARD CONNECTOR 61. TOUCH PAD CONNECTOR 62. MISC G/A (PMH7) 63. SUPER I/O (PC87382) 64. WIRELESS DISABLE SW 65. LEGACY IO INTERFACE 66. IR MODULE 67. THERMAL SENSOR 68. I2CBUS/SMBUS 69. FAN CONTROL 70. G-SENSOR 71. EMC DECOUPLING 72. RGB SWITCH 73. DC-IN 74. BATTERY CHARGER (MAX8632) 75. CHARGE SELECTOR 76. BATTERY INPUT 77. BATTERY MONITOR 78. POWER SEQUENCE 79. DC-DC VCC3M/VCC5M (MAX1901ETJ) 80. DC-DC VCCCPUCORE (ADP3207) 81. DC-DC VCORE INPUT CAP 82. DC-DC VCC1R8A/VCC0R9B (MAX8632) 83. DC-DC VCC1R5M/VCC1R05B (MAX1540ETJ) 84. BLANK 85. DC-DC VCC2R5M (BD3508EKN) 86. TSURUMAI-2 87. BLANK 88. LOAD SW 2 (AUX) 89. LOAD SW 3 (B,UBAY) 90. MAX POWER CTRL 91. POWER MOMITOR 92. PTH FOR SCREW HOLES |
|--|--|

41W0930

DESIGNER	Y.Y	12/01/05	PART NO.	41W0930	
CHECKED	Y.I	12/01/05	TITLE LISA-7(VER 5.04)		
APPROVED	T.S	12/01/05	TITLE PAGE		
CLASS			THIS DOCUMENT IS THE PROPERTY OF IBM. ITS USE IS AUTHORIZED ONLY FOR RESPONDING TO A REQUEST FOR QUOTATION OR FOR THE PERFORMANCE OF WORK FOR IBM. ALL QUESTIONS MUST BE REFERRED TO THE IBM PURCHASING DEPARTMENT.		
			LENOVO CONFIDENTIAL		

EC HISTORY

	DATE	EC NO.	PART NO.
	12/01/05	G33460	41W0930
			DEVELOPMENT NO.
			Q/M
			2 /92

SDV

VER.0.00 03/16/2005 APPLY INITIAL EC - DAV_I_SDV_EC002
 VER.0.01 03/22/2005 APPLY EC244,245
 VER.0.02 03/23/2005 APPLY EC247-249,251,252,254,255
 VER.0.03 03/25/2005 APPLY EC256,232,238,239,257,259,260,262
 VER.0.04 03/25/2005 APPLY EC263,265,266
 VER.0.05 03/31/2005 APPLY EC270
 VER.0.06 03/31/2005 APPLY EC267,269,271
 VER.0.07 04/05/2005 ERROR CORRECTION:PAGE-12 C7,C10

VER.2.11 08/04/2005 APPLY 112,113
 VER.2.12 08/05/2005 APPLY 117
 VER.2.13 08/12/2005 APPLY 119,122
 VER.2.14 08/22/2005 APPLY 123

SIT

VER.3.00 08/24/2005 APPLY SIT 001,002,005,006,007,008,010,011
 VER.3.01 08/29/2005 APPLY 013,016,017,019,021,022
 VER.3.02 08/30/2005 APPLY 027,028,030,031,032,034,035,036,037,038,039,040
 VER.3.03 09/01/2005 APPLY 044,045,046,048
 VER.3.04 09/02/2005 APPLY 049,050,051,052
 VER.3.05 09/05/2005 APPLY 054
 VER.3.06 09/08/2005 APPLY 060,061
 VER.3.07 09/13/2005 APPLY 062,CHG TO LP CLK GEN,063,064
 VER.3.08 09/21/2005 RN26,27,28 CHG TO 33-OHM 5% ,APPLY EC 068,069
 VER.3.09 09/22/2005 APPLY 070,071
 (EC 073 DISABLE THERMAL SENSOR IS NOT APPLIED TO LOGIC.
 IT'S APPLIED TO BOM/CPL ONLY.)

PHASE-3

VER.1.00 05/16/2005 APPLY EC001,002,007-024,026,028-030,035
 VER.1.01 05/17/2005 APPLY EC047,048
 VER.1.02 05/18/2005 APPLY EC046
 VER.1.03 05/19/2005 APPLY EC037,038,039,040,041,042,043,046(I2C)
 EC049,050,051,052
 VER.1.04 05/20/2005 APPLY EC054,055,056,057,059,060
 VER.1.05 05/24/2005 APPLY EC062,063,065,066,067
 VER.1.06 05/26/2005 CHANGE USB CONN.(J10),APPLY EC069,070,075
 VER.1.07 06/01/2005 APPLY EC071,073,076,079,EC080
 VER.1.08 06/01/2005 APPLY EC081
 VER.1.09 06/03/2005 APPLY EC082,EC084
 VER.1.10 06/10/2005 APPLY EC087,089,093,094,095
 VER.1.11 06/16/2005 APPLY EC096,097,098,099,100,101,102

SIT-R

VER.4.00 10/17/2005 APPLY SIT-R 001,003,004,005,008,009
 VER.4.01 10/20/2005 APPLY 012,013,014,017,019,020,021,022,023,024,025,026,028
 VER.4.02 10/21/2005 APPLY 030,035
 VER.4.03 10/24/2005 APPLY 037,038,039,041,043
 VER.4.04 10/25/2005 APPLY 044,047,049
 VER.4.05 10/26/2005 APPLY 048,050,057
 VER.4.06 10/27/2005 APPLY 059,060
 VER.4.07 11/02/2005 APPLY 062,064

PHASE-4

VER.2.00 06/29/2005 RENUMBER FET ID REQUESTED BY KOZASU-SAN
 APPLY EC002,003,004,006,011,012,014,015,016,
 018,019,020,021,022,024,025,028,029
 VER.2.01 07/08/2005 APPLY 030,032,034,035,039,041,042
 VER.2.02 07/14/2005 APPLY 044,045,046,047,048,049,050,051,056,057,
 060,061,062,063,064,065,066,067,068,069
 VER.2.03 07/19/2005 APPLY 070,071,073,078
 VER.2.04 07/20/2005 APPLY 023,072,081,082
 VER.2.05 07/21/2005 CORRECT CHIP-R VALUE/ADD CAP FOR EC045
 VER.2.06 07/27/2005 APPLY 086,087,088,089,093,094,095,096,097,098,100
 CHANGE WIRELESS SW TO SMK
 VER.2.07 07/28/2005 APPLY 017,036,101
 VER.2.08 07/29/2005 APPLY 104,EC100 CORRECTION
 VER.2.09 08/01/2005 APPLY 103,105,106
 VER.2.10 08/02/2005 APPLY 109,110,111

SVT

VER.5.00 11/08/2005 CHANGE HOLE SIZE,APPLY 002
 VER.5.01 11/14/2005 APPLY 005,012,016
 VER.5.02 11/16/2005 APPLY 019
 VER.5.03 11/21/2005 APPLY 021,022
 VER.5.04 12/01/2005 APPLY 023,024,027

41W0930

DESIGNER	Y.Y	12/01/05	PART NO.	41W0930	
CHECKED	Y.I	12/01/05			
APPROVED	T.S	12/01/05	TITLE LISA-7(VER 5.04)		
CLASS			HISTORY		
THIS DOCUMENT IS THE PROPERTY OF IBM ITS USE IS AUTHORIZED ONLY FOR RESPONDING TO A REQUEST FOR QUOTATION OR FOR THE PERFORMANCE OF WORK FOR IBM. ALL QUESTIONS MUST BE REFERRED TO THE IBM PURCHASING DEPARTMENT.				LENOVO CONFIDENTIAL	

DATE	EC NO.	PART NO.	
12/01/05	G33460	41W0930	
DEVELOPMENT NO.		Q/M	
3		/92	

U58

YONAH(1/3)

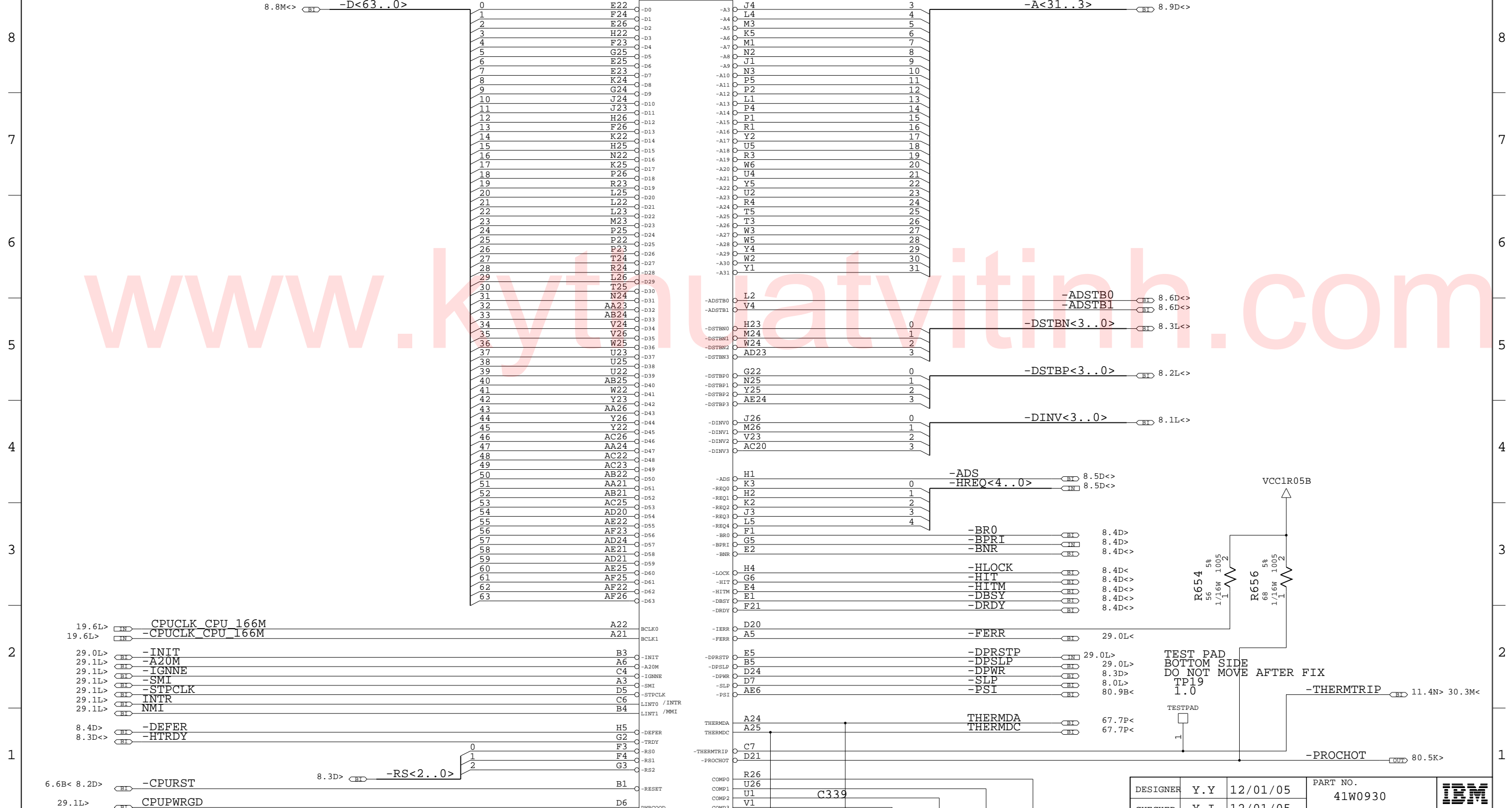

PLACE NEAR CPU

COMP0/2: Z0=27.4 OHM TRACE <0.5"
 COMP1/3: Z0=55 OHM TRACE <0.5"

DESIGNER	Y.Y	12/01/05	PART NO.	41W0930	IBM
CHECKED	Y.I	12/01/05	TITLE		
APPROVED	T.S	12/01/05	CLASS	CPU(1/3)	
THIS DOCUMENT IS THE PROPERTY OF IBM ITS USE IS AUTHORIZED ONLY FOR RESPONDING TO A REQUEST FOR QUOTATION OR FOR THE PERFORMANCE OF WORK FOR IBM. ALL QUESTIONS MUST BE REFERRED TO THE IBM PURCHASING DEPARTMENT.					LENOVO CONFIDENTIAL

41W0930

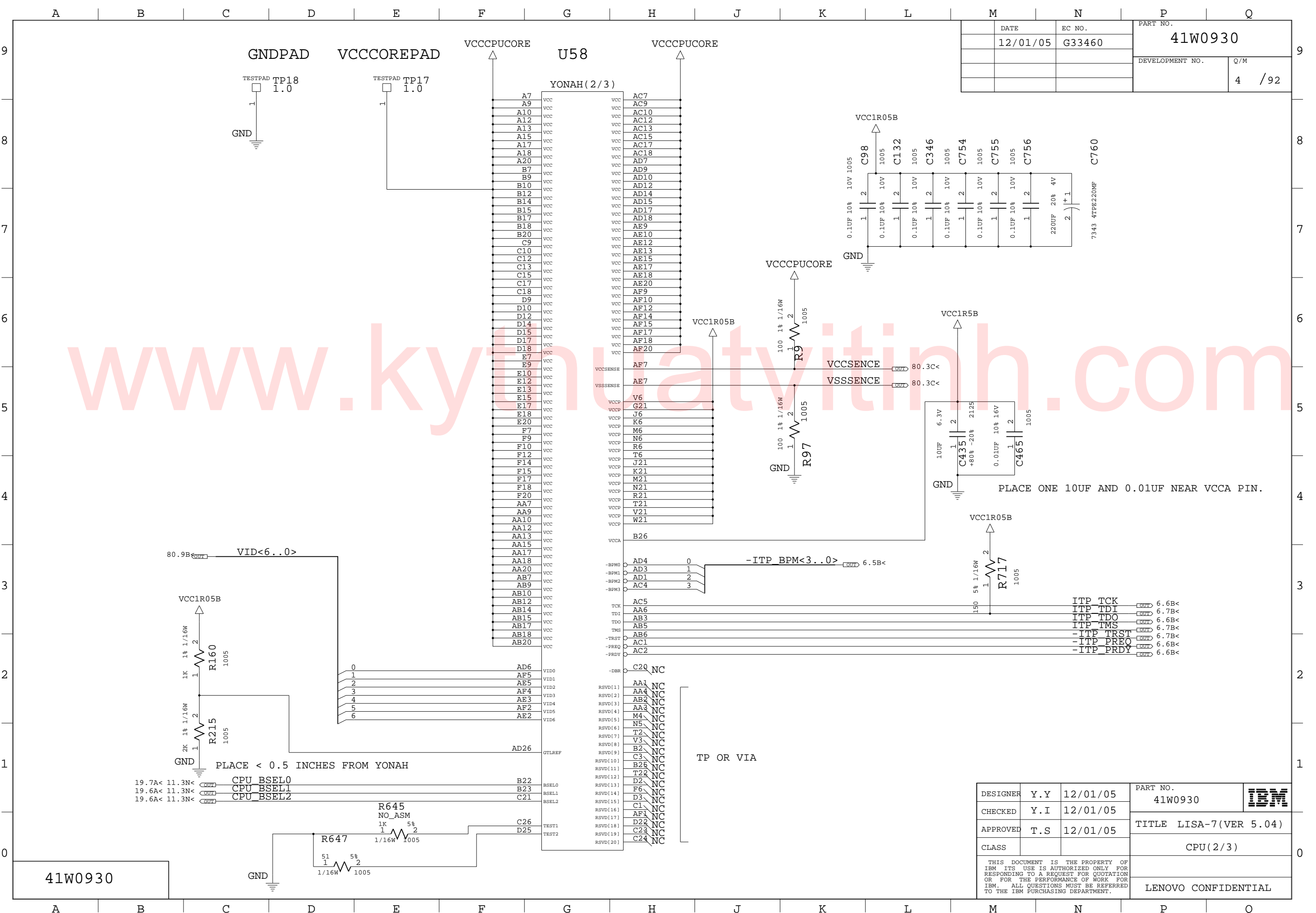

DATE	EC NO.	PART NO.	
12/01/05	G33460	41W0930	
DEVELOPMENT NO.		Q/M	
		4 / 92	

DESIGNER	Y.Y	12/01/05	PART NO.	41W0930	IBM
CHECKED	Y.I	12/01/05			
APPROVED	T.S	12/01/05	TITLE LISA-7(VER 5.04)		
CLASS			CPU(2/3)		
THIS DOCUMENT IS THE PROPERTY OF IBM ITS USE IS AUTHORIZED ONLY FOR RESPONDING TO A REQUEST FOR QUOTATION OR FOR THE PERFORMANCE OF WORK FOR IBM. ALL QUESTIONS MUST BE REFERRED TO THE IBM PURCHASING DEPARTMENT.					LENOVO CONFIDENTIAL

41W0930

www.kyoceraatvithinh.com

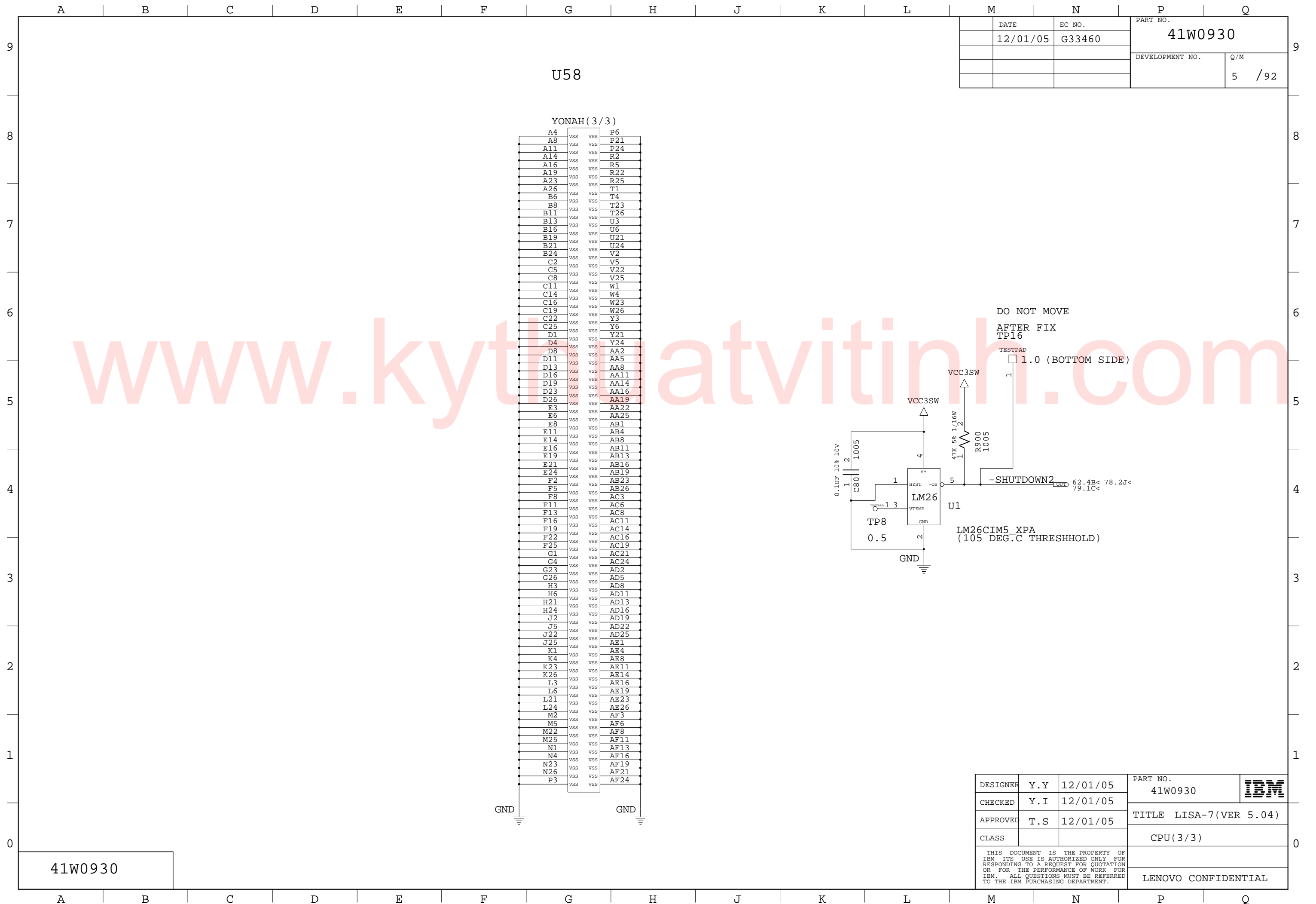

DATE	12/01/05	EC NO.	G33460	PART NO.	41W0930		
				DEVELOPMENT NO.	5	Q/M	/92

41W0930

DESIGNER	Y.Y	12/01/05	PART NO.	41W0930	IBM
CHECKED	Y.I	12/01/05	TITLE LISA-7(VER 5.04)		
APPROVED	T.S	12/01/05	CPU(3/3)		
CLASS					
THIS DOCUMENT IS THE PROPERTY OF IBM. ITS USE IS AUTHORIZED ONLY FOR RESPONDING TO A REQUEST FOR QUOTATION OR FOR THE PERFORMANCE OF WORK FOR IBM. ALL QUESTIONS MUST BE REFERRED TO THE IBM PURCHASING DEPARTMENT.					LENOVO CONFIDENTIAL

DATE	12/01/05	EC NO.	G33460	PART NO.	41W0930
				DEVELOPMENT NO.	6 / 92

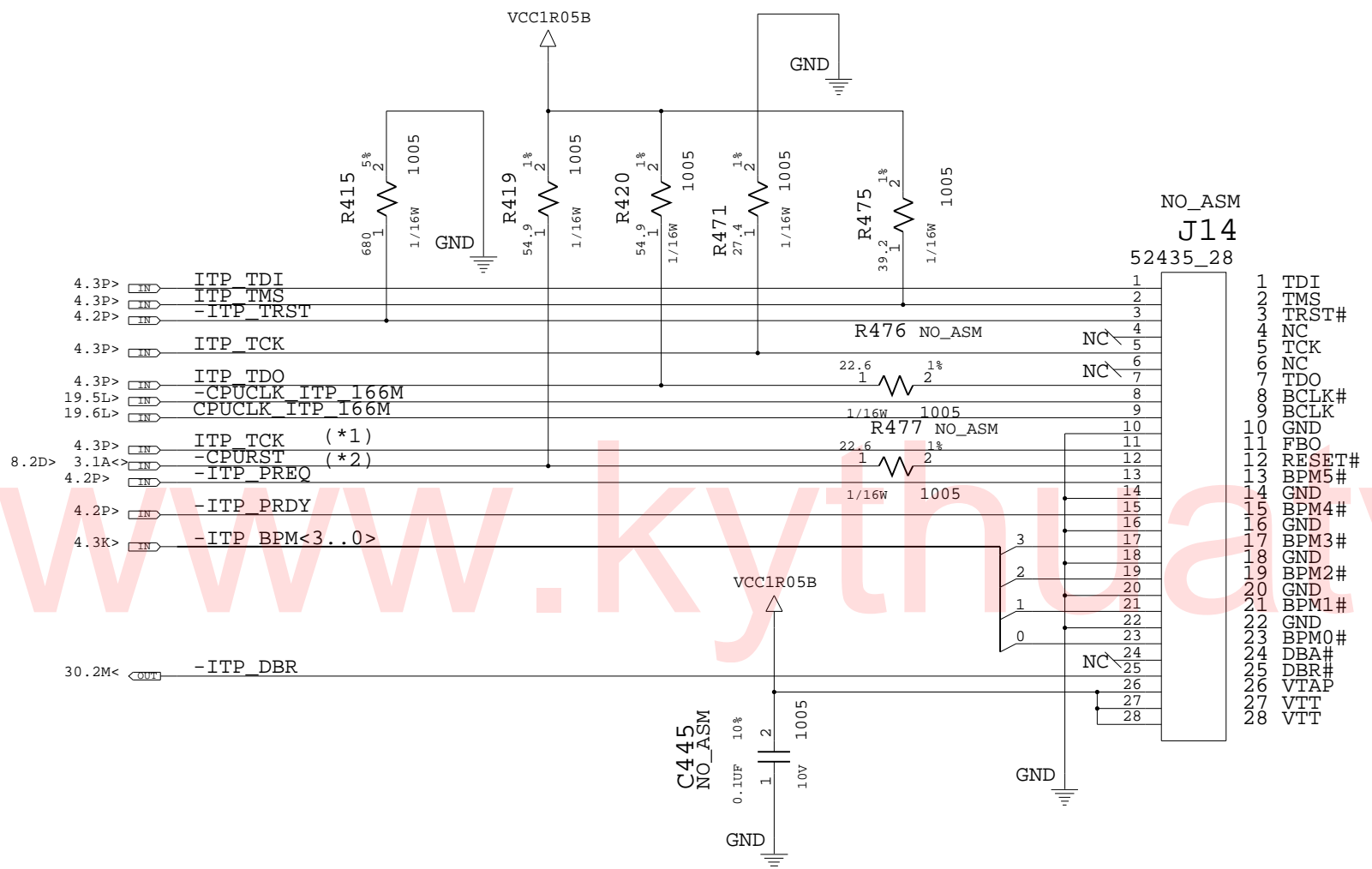

(*1) TCK SIGNAL IS BRANCHED AT YONAH PIN
 (*2) -CPURST SIGNAL IS BRANCHED AT CALISTOGA PIN

41W0930

DESIGNER	Y.Y	12/01/05	PART NO.	41W0930	IBM
CHECKED	Y.I	12/01/05	TITLE LISA-7(VER 5.04)		
APPROVED	T.S	12/01/05	ITP CONN/LARGE PTH HOLE		
CLASS			EMI FINGER		
THIS DOCUMENT IS THE PROPERTY OF IBM ITS USE IS AUTHORIZED ONLY FOR RESPONDING TO A REQUEST FOR QUOTATION OR FOR THE PERFORMANCE OF WORK FOR IBM. ALL QUESTIONS MUST BE REFERRED TO THE IBM PURCHASING DEPARTMENT.					LENOVO CONFIDENTIAL

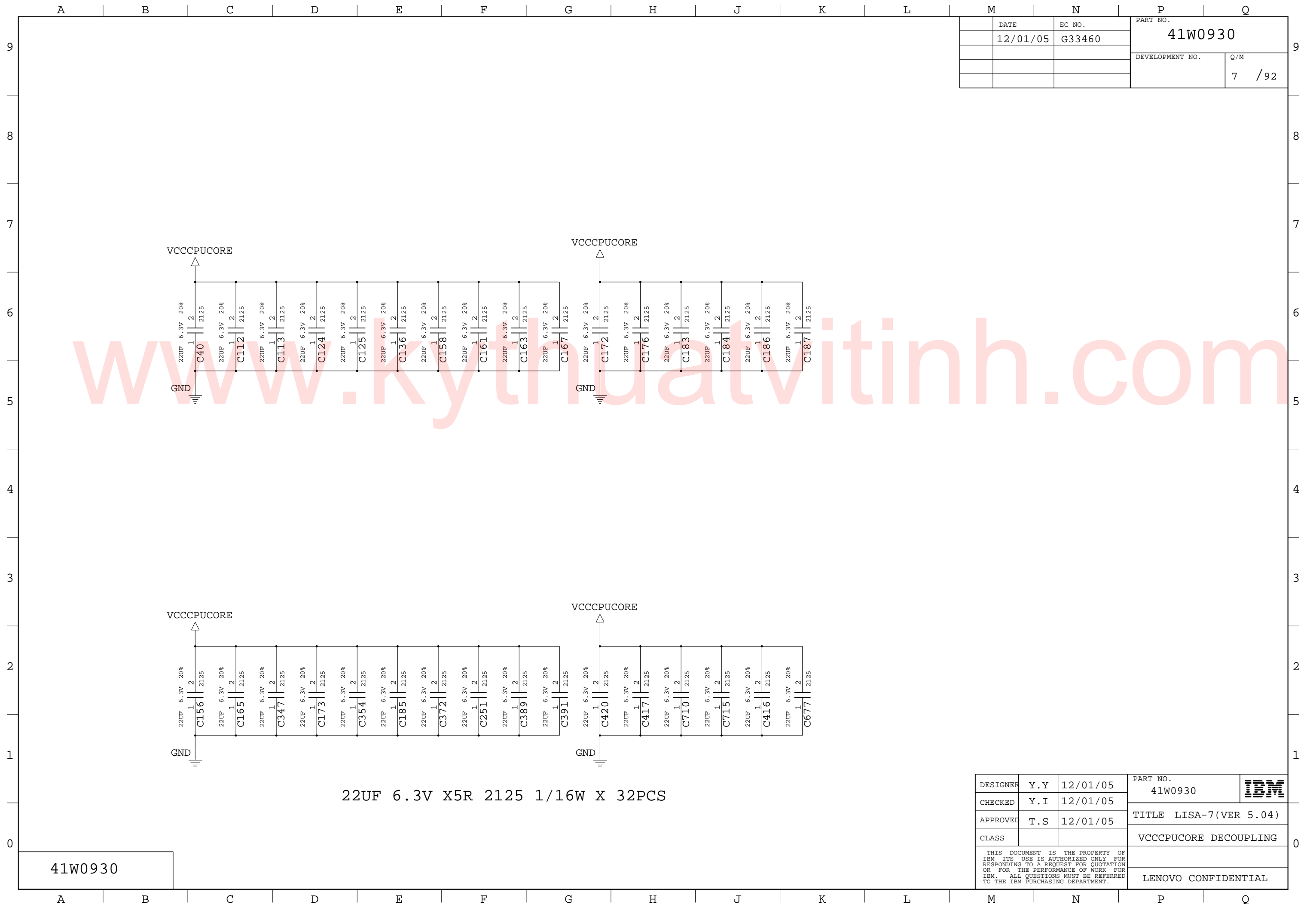

DATE	EC NO.	PART NO.	
12/01/05	G33460	41W0930	
		DEVELOPMENT NO.	Q/M
			7 /92

41W0930

DESIGNER	Y.Y	12/01/05	PART NO.	41W0930	
CHECKED	Y.I	12/01/05			
APPROVED	T.S	12/01/05	TITLE LISA-7(VER 5.04)		
CLASS			VCCCPUCORE DECOUPLING		
THIS DOCUMENT IS THE PROPERTY OF IBM ITS USE IS AUTHORIZED ONLY FOR RESPONDING TO A REQUEST FOR QUOTATION OR FOR THE PERFORMANCE OF WORK FOR IBM. ALL QUESTIONS MUST BE REFERRED TO THE IBM PURCHASING DEPARTMENT.					LENOVO CONFIDENTIAL

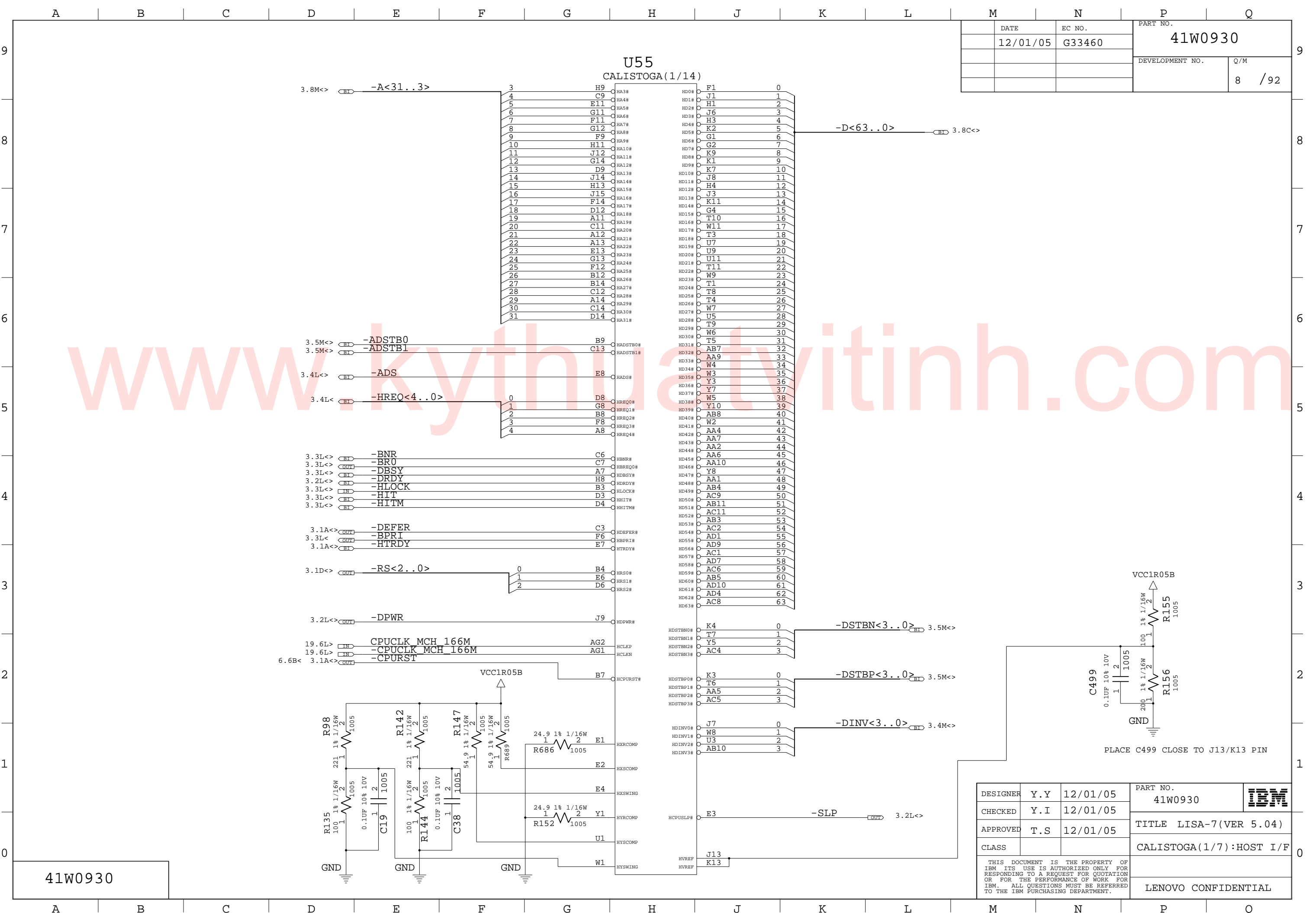

DATE	EC NO.	PART NO.	
12/01/05	G33460	41W0930	
		DEVELOPMENT NO.	Q/M
		8	/92

41W0930

DESIGNER	Y.Y	12/01/05	PART NO.	41W0930	IBM
CHECKED	Y.I	12/01/05	TITLE		
APPROVED	T.S	12/01/05	CALISTOGA(1/7):HOST I/F		
CLASS			LENOVO CONFIDENTIAL		

THIS DOCUMENT IS THE PROPERTY OF IBM ITS USE IS AUTHORIZED ONLY FOR RESPONDING TO A REQUEST FOR QUOTATION OR FOR THE PERFORMANCE OF WORK FOR IBM. ALL QUESTIONS MUST BE REFERRED TO THE IBM PURCHASING DEPARTMENT.

DATE	EC NO.	PART NO.
12/01/05	G33460	41W0930
DEVELOPMENT NO.		Q/M
		9 / 92

U55

CALISTOGA (2/14)

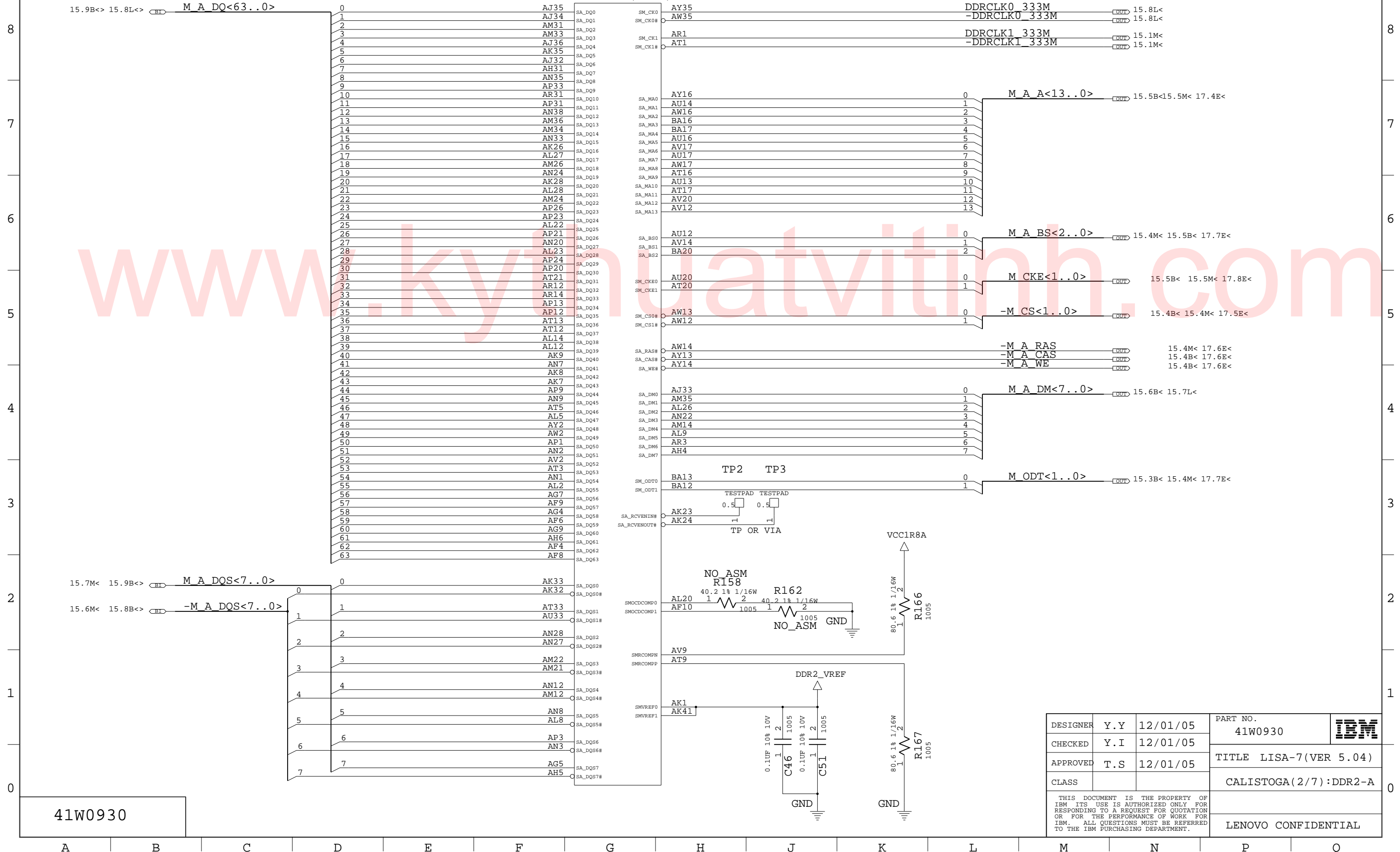

41W0930

DESIGNER	Y.Y	12/01/05	PART NO.	41W0930	IBM
CHECKED	Y.I	12/01/05	TITLE LISA-7(VER 5.04)		
APPROVED	T.S	12/01/05	CALISTOGA (2/7) : DDR2-A		
CLASS			LENOVO CONFIDENTIAL		

THIS DOCUMENT IS THE PROPERTY OF IBM. ITS USE IS AUTHORIZED ONLY FOR RESPONDING TO A REQUEST FOR QUOTATION OR FOR THE PERFORMANCE OF WORK FOR IBM. ALL QUESTIONS MUST BE REFERRED TO THE IBM PURCHASING DEPARTMENT.

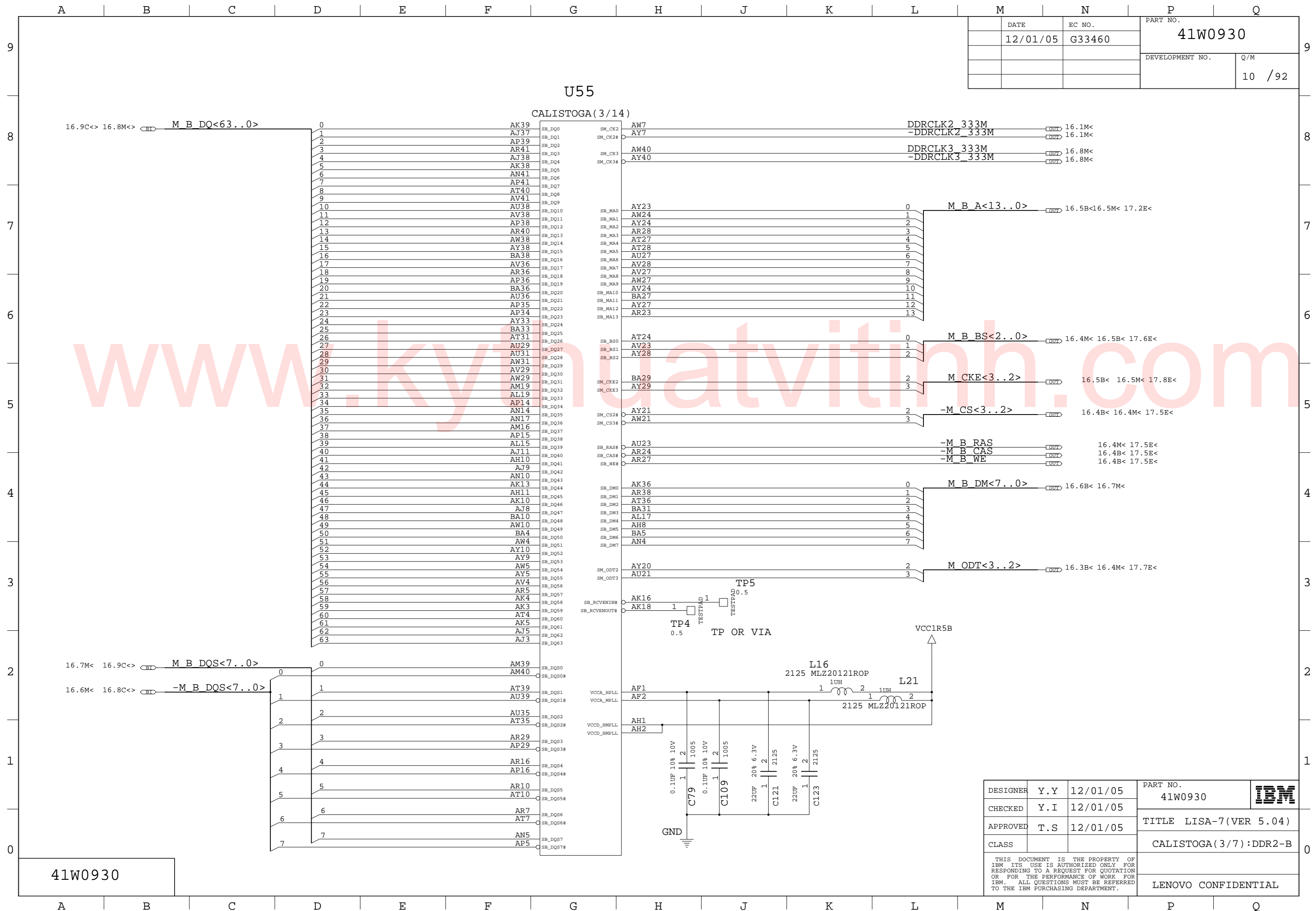

DATE	EC NO.	PART NO.	
12/01/05	G33460	41W0930	
		DEVELOPMENT NO.	Q/M
			10 /92

U55

CALISTOGA (3/14)

16.9C<> 16.8M<> M_B DQ<63..0>

DDRCLK2_333M
-DDRCLK2_333M
DDRCLK3_333M
-DDRCLK3_333M

M_B A<13..0>

M_B BS<2..0>

M_CKE<3..2>

-M_CS<3..2>

-M_B RAS
-M_B CAS
-M_B WE

M_B DM<7..0>

M_ODT<3..2>

16.7M< 16.9C<> M_B DQS<7..0>

16.6M< 16.8C<> -M_B DQS<7..0>

41W0930

DESIGNER	Y.Y	12/01/05	PART NO.	41W0930	IBM
CHECKED	Y.I	12/01/05			
APPROVED	T.S	12/01/05	TITLE LISA-7(VER 5.04)		
CLASS			CALISTOGA (3/7) :DDR2-B		
THIS DOCUMENT IS THE PROPERTY OF IBM ITS USE IS AUTHORIZED ONLY FOR RESPONDING TO A REQUEST FOR QUOTATION OR FOR THE PERFORMANCE OF WORK FOR IBM. ALL QUESTIONS MUST BE REFERRED TO THE IBM PURCHASING DEPARTMENT.					LENOVO CONFIDENTIAL

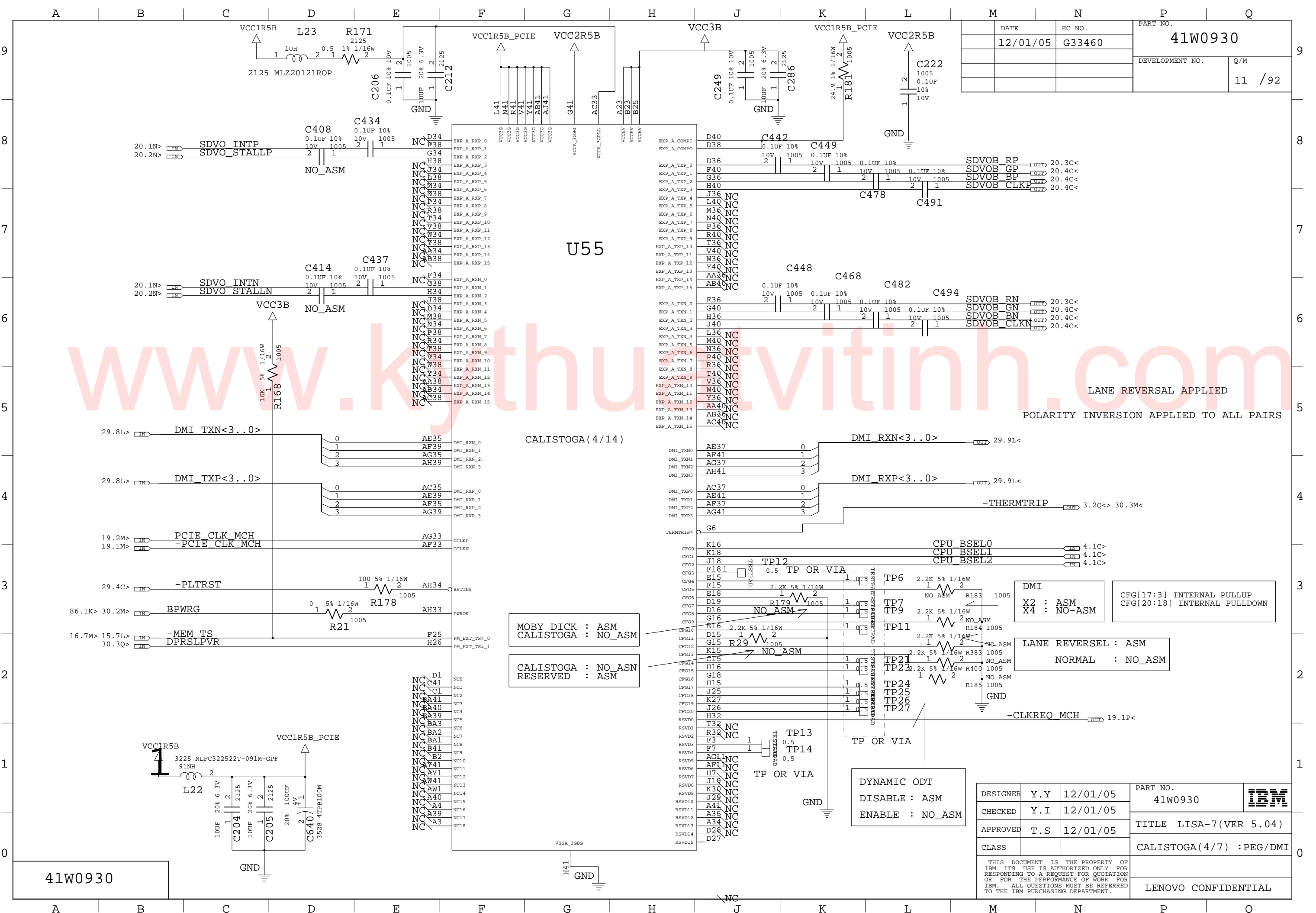

DATE	EC NO.	PART NO.
12/01/05	G33460	41W0930
DEVELOPMENT NO.		Q/M
		11 / 92

CALISTOGA (4/14)

MOBY DICK : ASM
CALISTOGA : NO_ASM

CALISTOGA : NO_ASM
RESERVED : ASM

LANE REVERSAL APPLIED
POLARITY INVERSION APPLIED TO ALL PAIRS

DMI
X2 : ASM
X4 : NO-ASM

LANE REVERSEL : ASM
NORMAL : NO_ASM

DYNAMIC ODT
DISABLE : ASM
ENABLE : NO_ASM

DESIGNER	Y.Y	12/01/05	PART NO.	41W0930	
CHECKED	Y.I	12/01/05	TITLE LISA-7(VER 5.04)		
APPROVED	T.S	12/01/05	CLASS CALISTOGA(4/7) : PEG/DMI		

THIS DOCUMENT IS THE PROPERTY OF IBM ITS USE IS AUTHORIZED ONLY FOR RESPONDING TO A REQUEST FOR QUOTATION OR FOR THE PERFORMANCE OF WORK FOR IBM. ALL QUESTIONS MUST BE REFERRED TO THE IBM PURCHASING DEPARTMENT.

LENOVO CONFIDENTIAL

41W0930

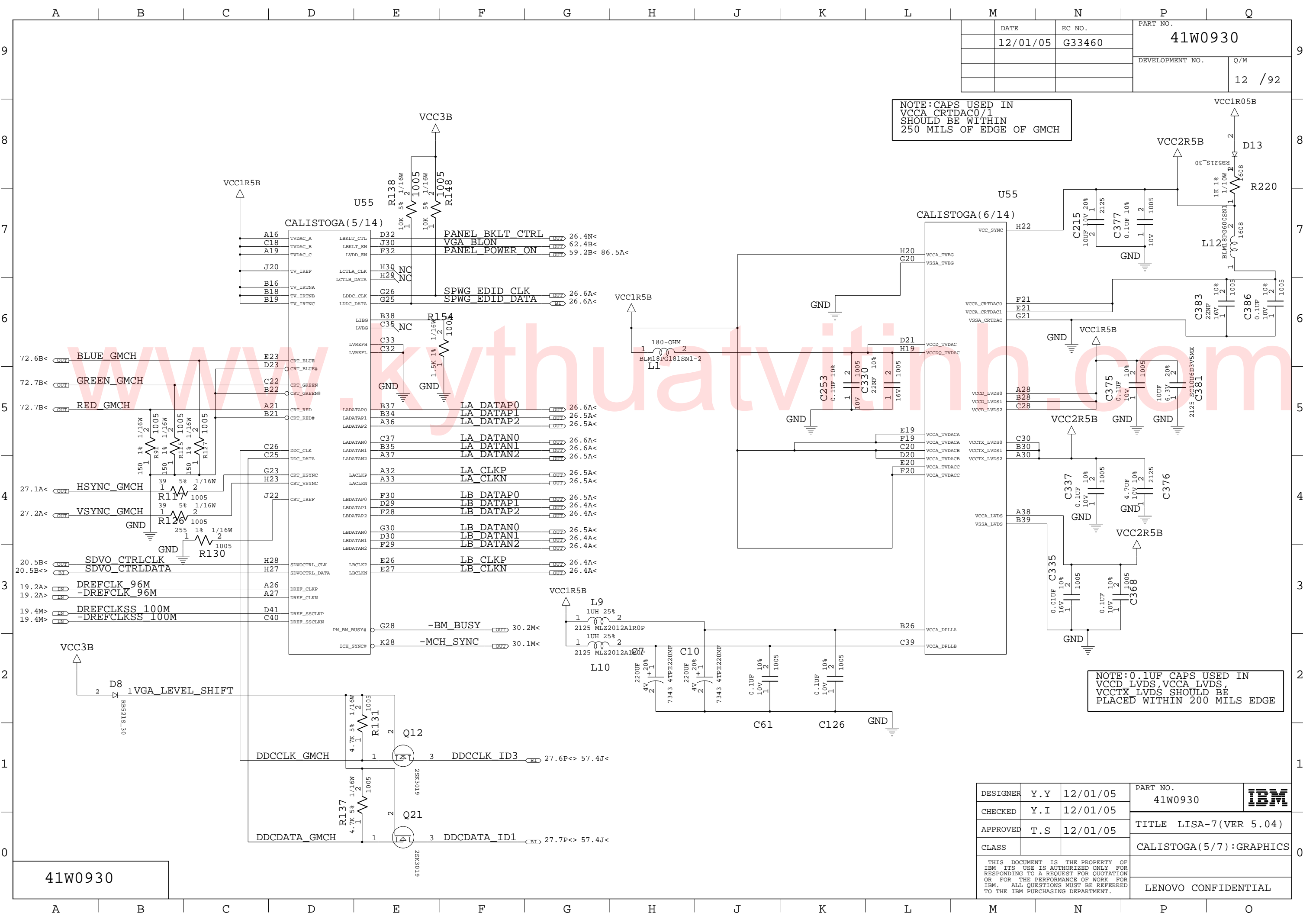

DATE	EC NO.	PART NO.
12/01/05	G33460	41W0930
DEVELOPMENT NO.		Q/M
		12 / 92

NOTE: CAPS USED IN VCCA_CRTDAC0/1 SHOULD BE WITHIN 250 MILS OF EDGE OF GMCH

NOTE: 0.1UF CAPS USED IN VCCD LVDS, VCCA LVDS, VCCCTX LVDS SHOULD BE PLACED WITHIN 200 MILS EDGE

41W0930

DESIGNER	Y.Y	12/01/05	PART NO.	41W0930	IBM
CHECKED	Y.I	12/01/05	TITLE LISA-7(VER 5.04)		
APPROVED	T.S	12/01/05	CALISTOGA(5/7):GRAPHICS		
CLASS			LENOVO CONFIDENTIAL		

THIS DOCUMENT IS THE PROPERTY OF IBM. ITS USE IS AUTHORIZED ONLY FOR RESPONDING TO A REQUEST FOR QUOTATION OR FOR THE PERFORMANCE OF WORK FOR IBM. ALL QUESTIONS MUST BE REFERRED TO THE IBM PURCHASING DEPARTMENT.

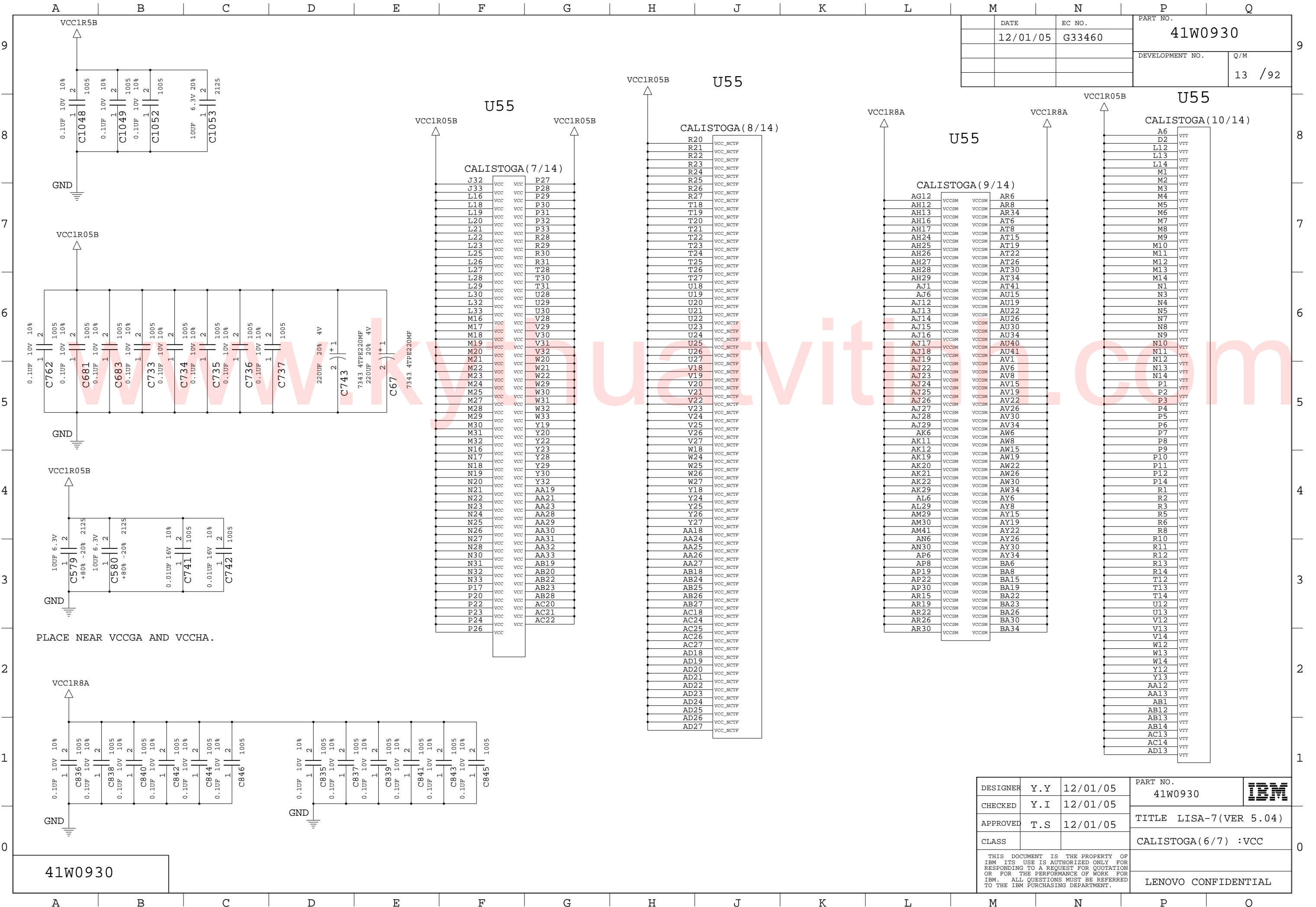

DATE	12/01/05	EC NO.	G33460	PART NO.	41W0930	
				DEVELOPMENT NO.	Q/M	
				13 / 92		

U55 CALISTOGA (7/14)

J32	VCC	P27
J33	VCC	P28
L16	VCC	P29
L18	VCC	P30
L19	VCC	P31
L20	VCC	P32
L21	VCC	P33
L22	VCC	R28
L23	VCC	R29
L25	VCC	R30
L26	VCC	R31
L27	VCC	T28
L28	VCC	T30
L29	VCC	T31
L30	VCC	U28
L32	VCC	U29
L33	VCC	U30
M16	VCC	V28
M17	VCC	V29
M18	VCC	V30
M19	VCC	V31
M20	VCC	V32
M21	VCC	W20
M22	VCC	W21
M23	VCC	W22
M24	VCC	W29
M25	VCC	W30
M27	VCC	W31
M28	VCC	W32
M29	VCC	W33
M30	VCC	Y19
M31	VCC	Y20
M32	VCC	Y22
N16	VCC	Y23
N17	VCC	Y28
N18	VCC	Y29
N19	VCC	Y30
N20	VCC	Y32
N21	VCC	AA19
N22	VCC	AA21
N23	VCC	AA23
N24	VCC	AA28
N25	VCC	AA29
N26	VCC	AA30
N27	VCC	AA31
N28	VCC	AA32
N30	VCC	AA33
N31	VCC	AA27
N32	VCC	AB20
N33	VCC	AB22
P17	VCC	AB23
P20	VCC	AB28
P22	VCC	AC20
P23	VCC	AC21
P24	VCC	AC24
P26	VCC	AC22

U55 CALISTOGA (8/14)

R20	VCC_NCTF
R21	VCC_NCTF
R22	VCC_NCTF
R23	VCC_NCTF
R24	VCC_NCTF
R25	VCC_NCTF
R26	VCC_NCTF
R27	VCC_NCTF
T18	VCC_NCTF
T19	VCC_NCTF
T20	VCC_NCTF
T21	VCC_NCTF
T22	VCC_NCTF
T23	VCC_NCTF
T24	VCC_NCTF
T25	VCC_NCTF
T26	VCC_NCTF
T27	VCC_NCTF
U18	VCC_NCTF
U19	VCC_NCTF
U20	VCC_NCTF
U21	VCC_NCTF
U22	VCC_NCTF
U23	VCC_NCTF
U24	VCC_NCTF
U25	VCC_NCTF
U26	VCC_NCTF
U27	VCC_NCTF
V18	VCC_NCTF
V19	VCC_NCTF
V20	VCC_NCTF
V21	VCC_NCTF
V22	VCC_NCTF
V23	VCC_NCTF
V24	VCC_NCTF
V25	VCC_NCTF
V26	VCC_NCTF
V27	VCC_NCTF
W18	VCC_NCTF
W24	VCC_NCTF
W25	VCC_NCTF
W26	VCC_NCTF
W27	VCC_NCTF
Y18	VCC_NCTF
Y24	VCC_NCTF
Y25	VCC_NCTF
Y26	VCC_NCTF
Y27	VCC_NCTF
AA18	VCC_NCTF
AA24	VCC_NCTF
AA32	VCC_NCTF
AA33	VCC_NCTF
AA27	VCC_NCTF
AB18	VCC_NCTF
AB24	VCC_NCTF
AB25	VCC_NCTF
AB26	VCC_NCTF
AB27	VCC_NCTF
AC18	VCC_NCTF
AC24	VCC_NCTF
AC25	VCC_NCTF
AC26	VCC_NCTF
AC27	VCC_NCTF
AD18	VCC_NCTF
AD19	VCC_NCTF
AD20	VCC_NCTF
AD21	VCC_NCTF
AD22	VCC_NCTF
AD23	VCC_NCTF
AD24	VCC_NCTF
AD25	VCC_NCTF
AD26	VCC_NCTF
AD27	VCC_NCTF

U55 CALISTOGA (9/14)

AG12	VCCSM	AR6
AH12	VCCSM	AR8
AH13	VCCSM	AR34
AH16	VCCSM	AT6
AH17	VCCSM	AT8
AH24	VCCSM	AT15
AH25	VCCSM	AT19
AH26	VCCSM	AT22
AH27	VCCSM	AT26
AH28	VCCSM	AT30
AH29	VCCSM	AT34
AJ1	VCCSM	AT41
AJ6	VCCSM	AU15
AJ12	VCCSM	AU19
AJ13	VCCSM	AU22
AJ14	VCCSM	AU26
AJ15	VCCSM	AU30
AJ16	VCCSM	AU34
AJ17	VCCSM	AU40
AJ18	VCCSM	AU41
AJ19	VCCSM	AV1
AJ22	VCCSM	AV6
AJ23	VCCSM	AV8
AJ24	VCCSM	AV15
AJ25	VCCSM	AV19
AJ26	VCCSM	AV22
AJ27	VCCSM	AV26
AJ29	VCCSM	AV30
AK6	VCCSM	AW6
AK11	VCCSM	AW8
AK12	VCCSM	AW15
AK19	VCCSM	AW19
AK20	VCCSM	AW22
AK21	VCCSM	AW26
AK22	VCCSM	AW30
AK29	VCCSM	AW34
AL6	VCCSM	AY6
AL29	VCCSM	AY8
AM29	VCCSM	AY15
AM30	VCCSM	AY19
AM41	VCCSM	AY22
AN6	VCCSM	AY26
AN30	VCCSM	AY30
AP6	VCCSM	AY34
AP8	VCCSM	BA6
AP19	VCCSM	BA8
AP22	VCCSM	BA15
AP30	VCCSM	BA19
AR15	VCCSM	BA22
AR19	VCCSM	BA23
AR22	VCCSM	BA26
AR26	VCCSM	BA30
AR30	VCCSM	BA34

U55 CALISTOGA (10/14)

A6	VTT
D2	VTT
L12	VTT
L13	VTT
L14	VTT
M1	VTT
M2	VTT
M3	VTT
M4	VTT
M5	VTT
M6	VTT
M7	VTT
M8	VTT
M9	VTT
M10	VTT
M11	VTT
M12	VTT
M13	VTT
M14	VTT
N1	VTT
N3	VTT
N4	VTT
N5	VTT
N7	VTT
N8	VTT
N9	VTT
N10	VTT
N11	VTT
N12	VTT
N13	VTT
N14	VTT
P1	VTT
P2	VTT
P3	VTT
P4	VTT
P5	VTT
P6	VTT
P7	VTT
P8	VTT
P9	VTT
P10	VTT
P11	VTT
P12	VTT
P14	VTT
R1	VTT
R2	VTT
R3	VTT
R5	VTT
R6	VTT
R8	VTT
R10	VTT
R11	VTT
R12	VTT
R13	VTT
R14	VTT
T12	VTT
T13	VTT
T14	VTT
U12	VTT
U13	VTT
V13	VTT
V14	VTT
W12	VTT
W13	VTT
W14	VTT
Y12	VTT
Y13	VTT
AA12	VTT
AA13	VTT
AB1	VTT
AB12	VTT
AB13	VTT
AB14	VTT
AC13	VTT
AC14	VTT
AD13	VTT

PLACE NEAR VCCGA AND VCCHA.

41W0930

DESIGNER	Y.Y	12/01/05	PART NO.	41W0930	
CHECKED	Y.I	12/01/05	TITLE		
APPROVED	T.S	12/01/05	CLASS CALISTOGA(6/7) :VCC		
THIS DOCUMENT IS THE PROPERTY OF IBM ITS USE IS AUTHORIZED ONLY FOR RESPONDING TO A REQUEST FOR QUOTATION OR FOR THE PERFORMANCE OF WORK FOR IBM. ALL QUESTIONS MUST BE REFERRED TO THE IBM PURCHASING DEPARTMENT.					LENOVO CONFIDENTIAL

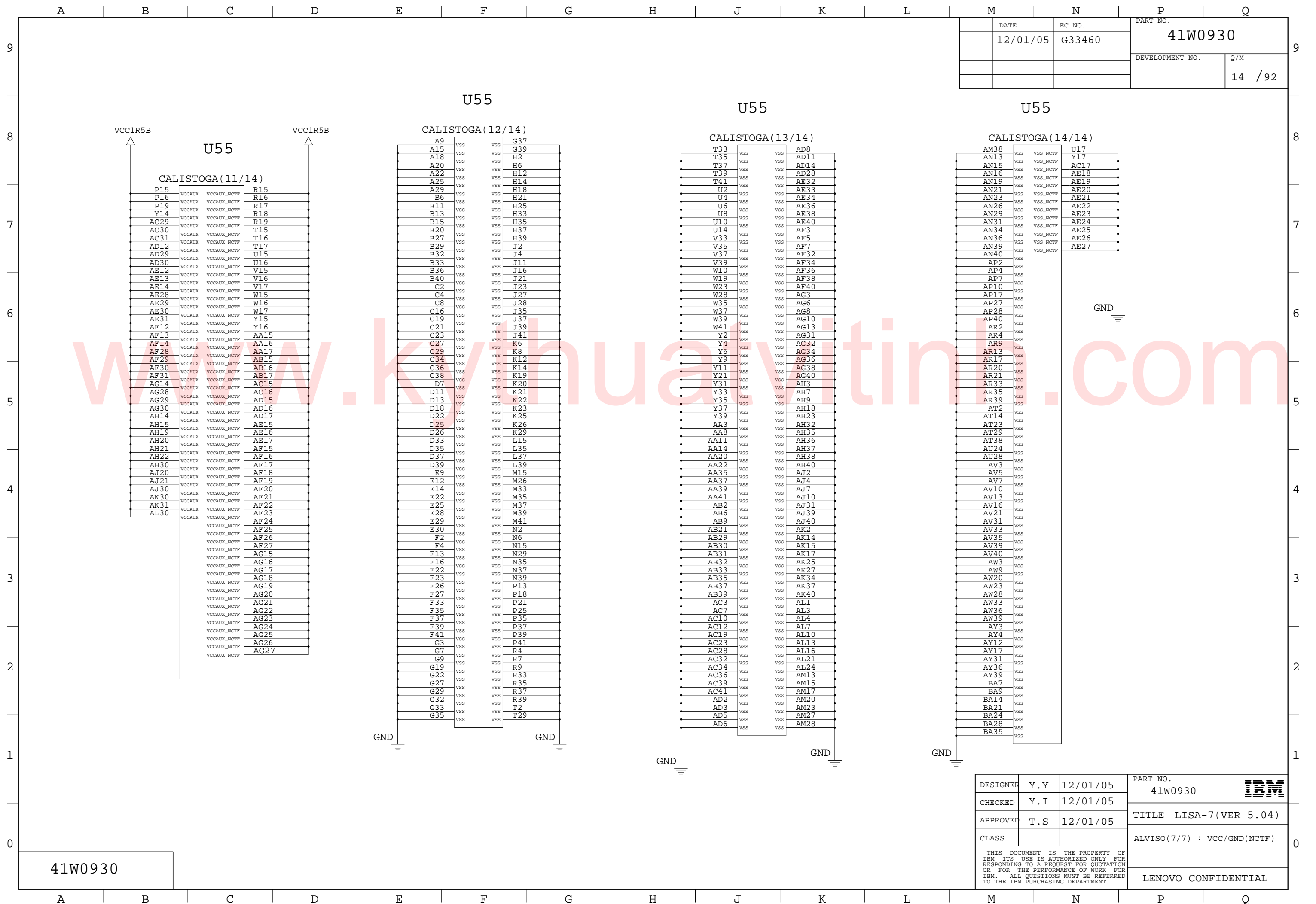

DATE	EC NO.	PART NO.	
12/01/05	G33460	41W0930	
		DEVELOPMENT NO.	Q/M
			14 / 92

41W0930

DESIGNER	Y. Y	12/01/05	PART NO.	41W0930	IBM
CHECKED	Y. I	12/01/05	TITLE		
APPROVED	T. S	12/01/05	ALVISO(7/7) : VCC/GND(NCTF)		
CLASS			THIS DOCUMENT IS THE PROPERTY OF IBM ITS USE IS AUTHORIZED ONLY FOR RESPONDING TO A REQUEST FOR QUOTATION OR FOR THE PERFORMANCE OF WORK FOR IBM. ALL QUESTIONS MUST BE REFERRED TO THE IBM PURCHASING DEPARTMENT.		
			LENOVO CONFIDENTIAL		

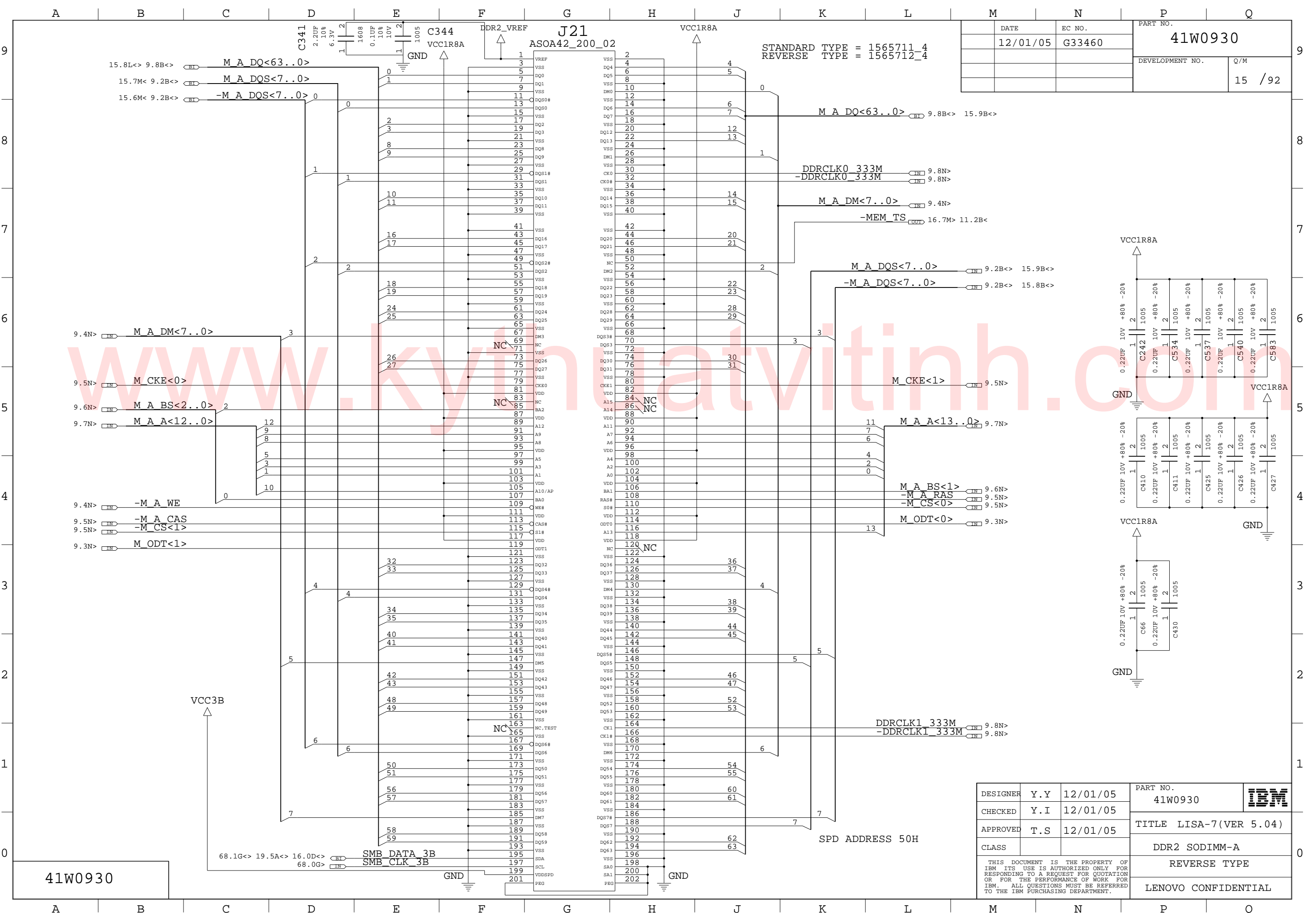

DATE	EC NO.	PART NO.
12/01/05	G33460	41W0930
DEVELOPMENT NO.		Q/M
		15 / 92

STANDARD TYPE = 1565711_4
 REVERSE TYPE = 1565712_4

DESIGNER	Y.Y	12/01/05	PART NO.	41W0930	
CHECKED	Y.I	12/01/05	TITLE LISA-7(VER 5.04)		
APPROVED	T.S	12/01/05	DDR2 SODIMM-A		
CLASS			REVERSE TYPE		
THIS DOCUMENT IS THE PROPERTY OF IBM ITS USE IS AUTHORIZED ONLY FOR RESPONDING TO A REQUEST FOR QUOTATION OR FOR THE PERFORMANCE OF WORK FOR IBM. ALL QUESTIONS MUST BE REFERRED TO THE IBM PURCHASING DEPARTMENT.					LENOVO CONFIDENTIAL

41W0930

SPD ADDRESS 50H

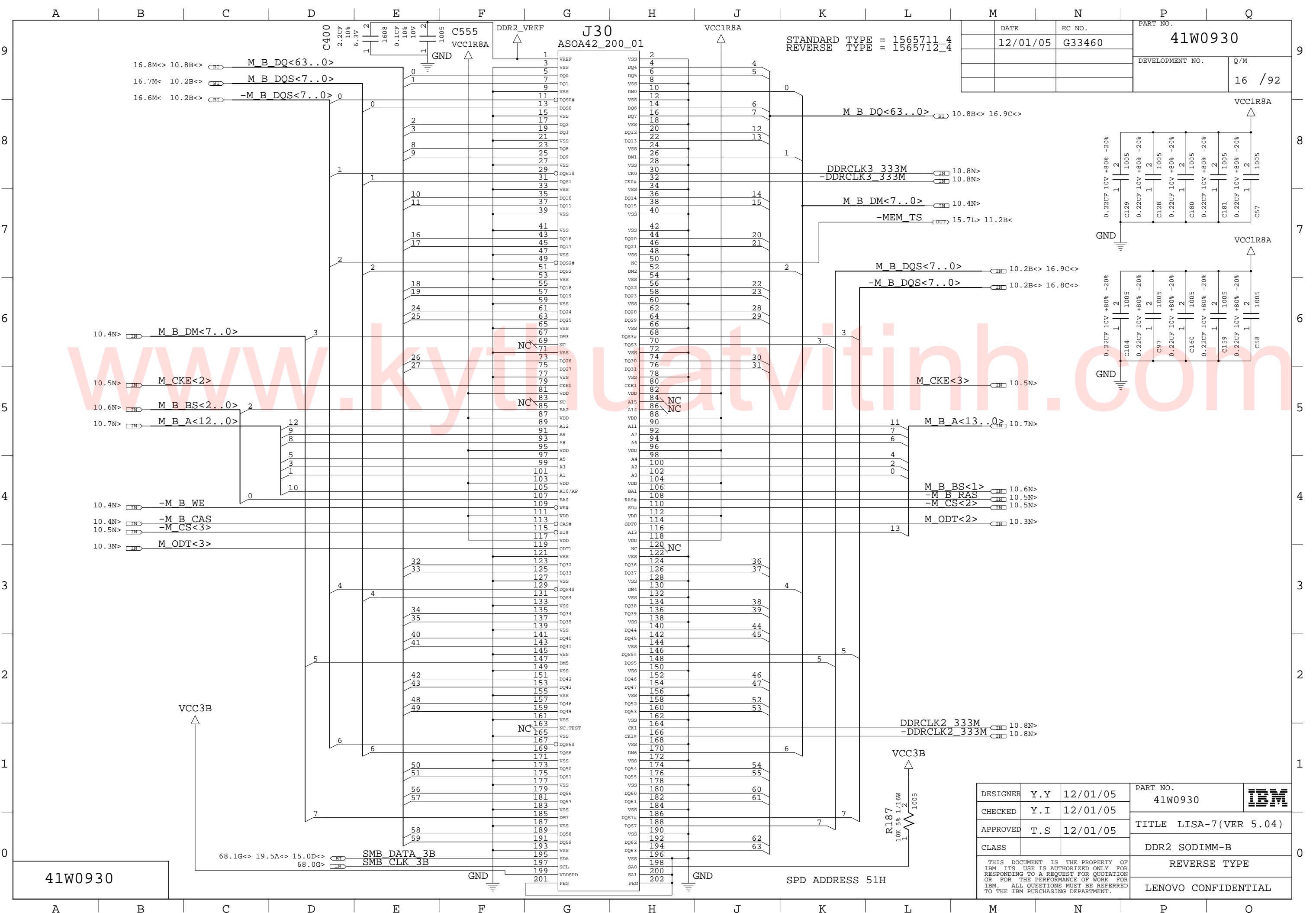

DATE	12/01/05	EC NO.	G33460	PART NO.	41W0930
				DEVELOPMENT NO.	Q/M
					16 / 92

DESIGNER	Y.Y	12/01/05	PART NO.	41W0930	
CHECKED	Y.I	12/01/05	TITLE LISA-7(VER 5.04)		
APPROVED	T.S	12/01/05	CLASS DDR2 SODIMM-B		
				REVERSE TYPE	
				LENOVO CONFIDENTIAL	

41W0930

THIS DOCUMENT IS THE PROPERTY OF IBM ITS USE IS AUTHORIZED ONLY FOR RESPONDING TO A REQUEST FOR QUOTATION OR FOR THE PERFORMANCE OF WORK FOR IBM. ALL QUESTIONS MUST BE REFERRED TO THE IBM PURCHASING DEPARTMENT.

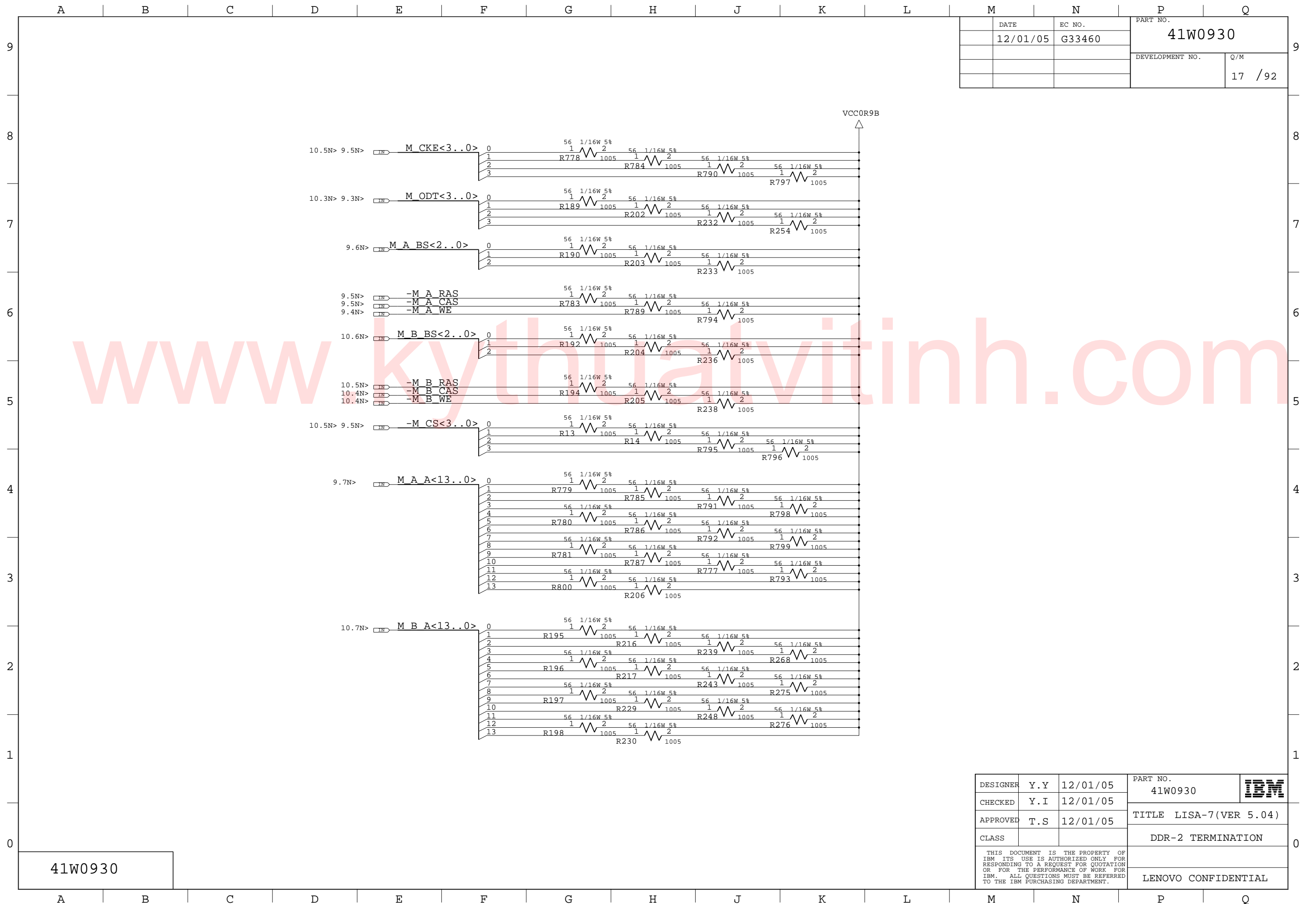

DATE	EC NO.	PART NO.	
12/01/05	G33460	41W0930	
		DEVELOPMENT NO.	Q/M
			17 / 92

41W0930

DESIGNER	Y.Y	12/01/05	PART NO.	41W0930	IBM
CHECKED	Y.I	12/01/05			
APPROVED	T.S	12/01/05	TITLE LISA-7(VER 5.04)		
CLASS			DDR-2 TERMINATION		
THIS DOCUMENT IS THE PROPERTY OF IBM. ITS USE IS AUTHORIZED ONLY FOR RESPONDING TO A REQUEST FOR QUOTATION OR FOR THE PERFORMANCE OF WORK FOR IBM. ALL QUESTIONS MUST BE REFERRED TO THE IBM PURCHASING DEPARTMENT.				LENOVO CONFIDENTIAL	

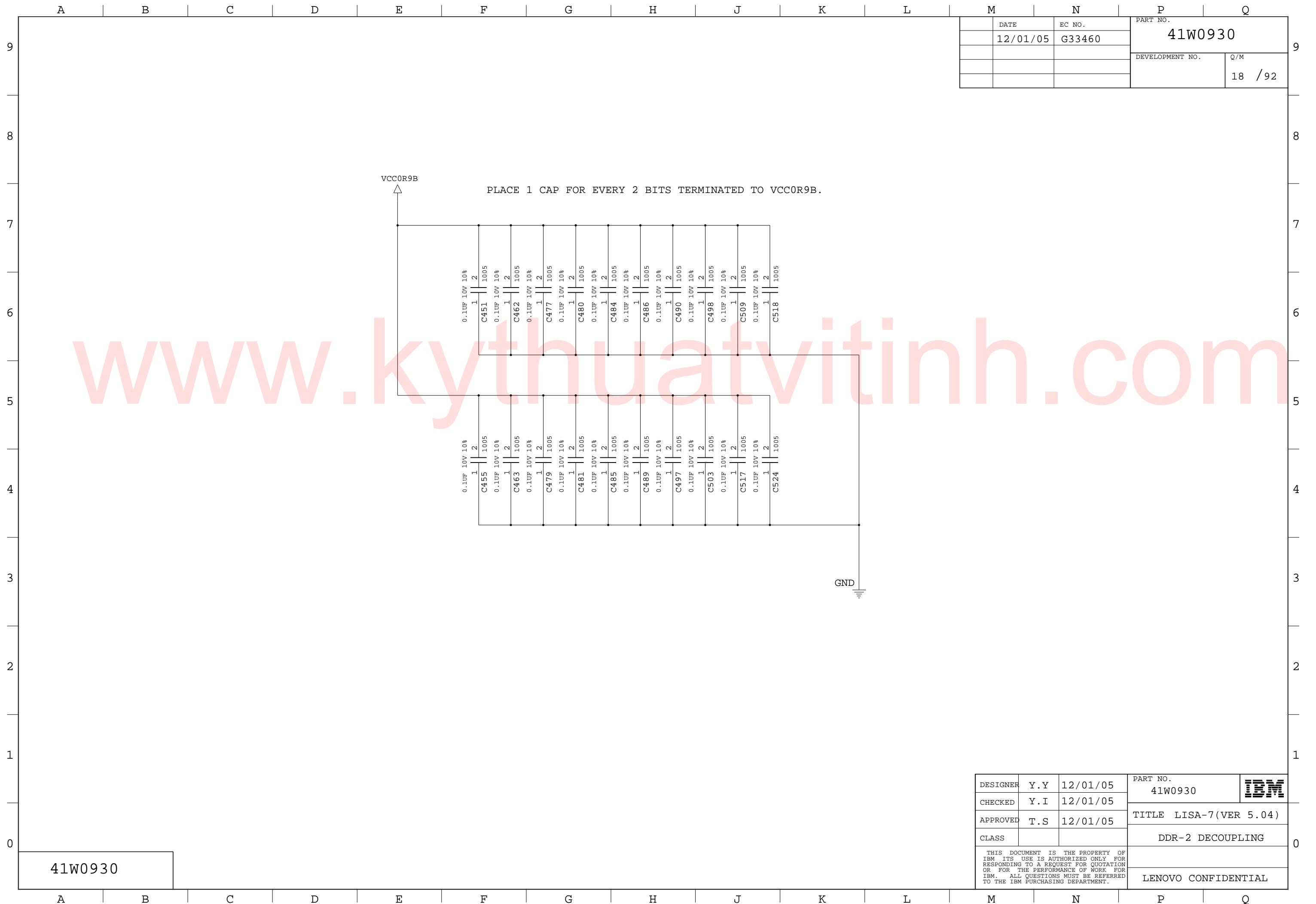

DATE	EC NO.	PART NO.	
12/01/05	G33460	41W0930	
		DEVELOPMENT NO.	Q/M
			18 /92

41W0930

DESIGNER	Y.Y	12/01/05	PART NO.	41W0930	
CHECKED	Y.I	12/01/05	TITLE		
APPROVED	T.S	12/01/05	DDR-2 DECOUPLING		
CLASS			LENOVO CONFIDENTIAL		
<small>THIS DOCUMENT IS THE PROPERTY OF IBM ITS USE IS AUTHORIZED ONLY FOR RESPONDING TO A REQUEST FOR QUOTATION OR FOR THE PERFORMANCE OF WORK FOR IBM. ALL QUESTIONS MUST BE REFERRED TO THE IBM PURCHASING DEPARTMENT.</small>					

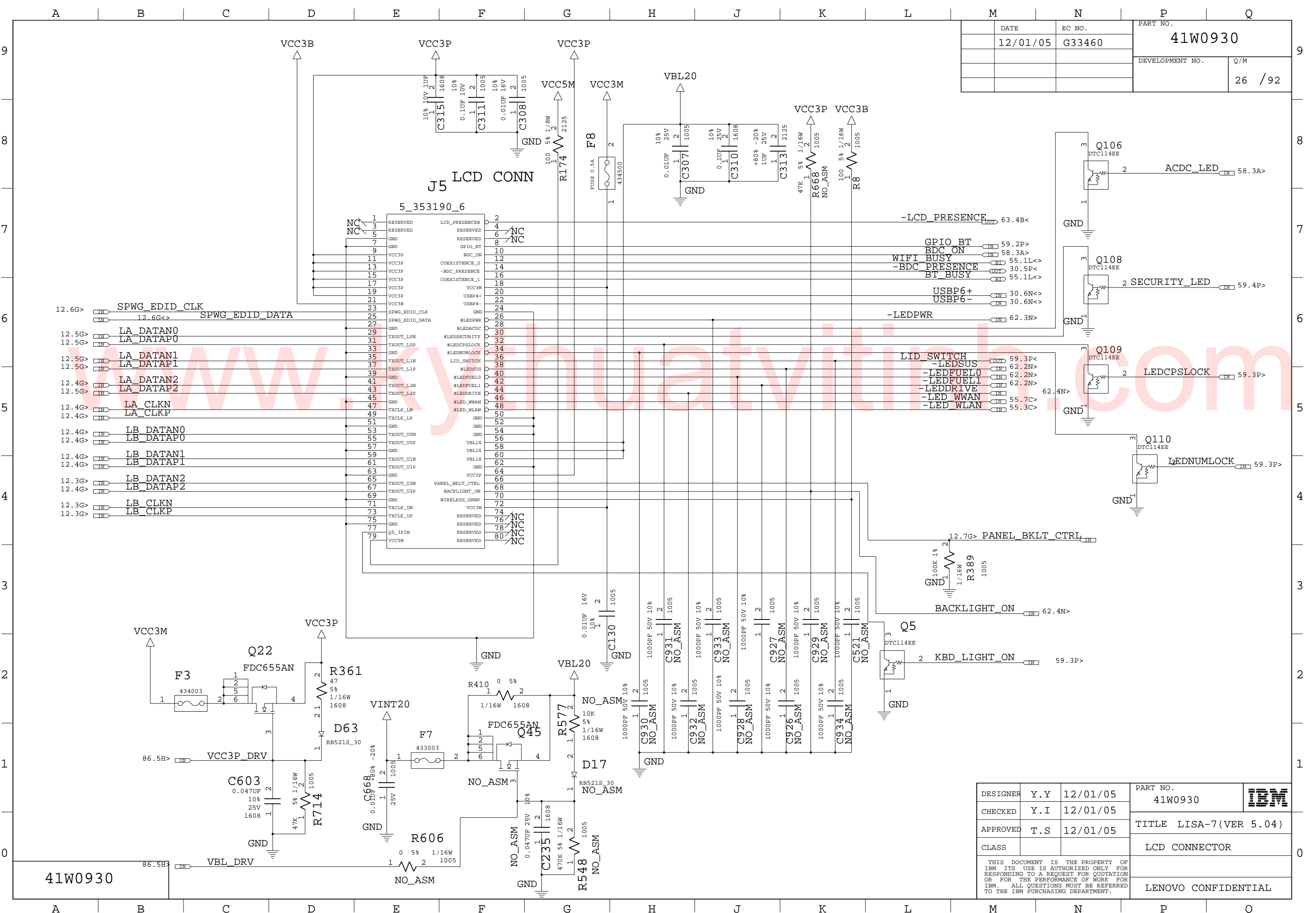

DATE	EC NO.	PART NO.
12/01/05	G33460	41W0930
DEVELOPMENT NO.		Q/M
		26 / 92

41W0930

DESIGNER	Y.Y	12/01/05	PART NO.	41W0930	
CHECKED	Y.I	12/01/05	TITLE LISA-7(VER 5.04)		
APPROVED	T.S	12/01/05	LCD CONNECTOR		
CLASS			LENOVO CONFIDENTIAL		

THIS DOCUMENT IS THE PROPERTY OF IBM. ITS USE IS AUTHORIZED ONLY FOR RESPONDING TO A REQUEST FOR QUOTATION OR FOR THE PERFORMANCE OF WORK FOR IBM. ALL QUESTIONS MUST BE REFERRED TO THE IBM PURCHASING DEPARTMENT.

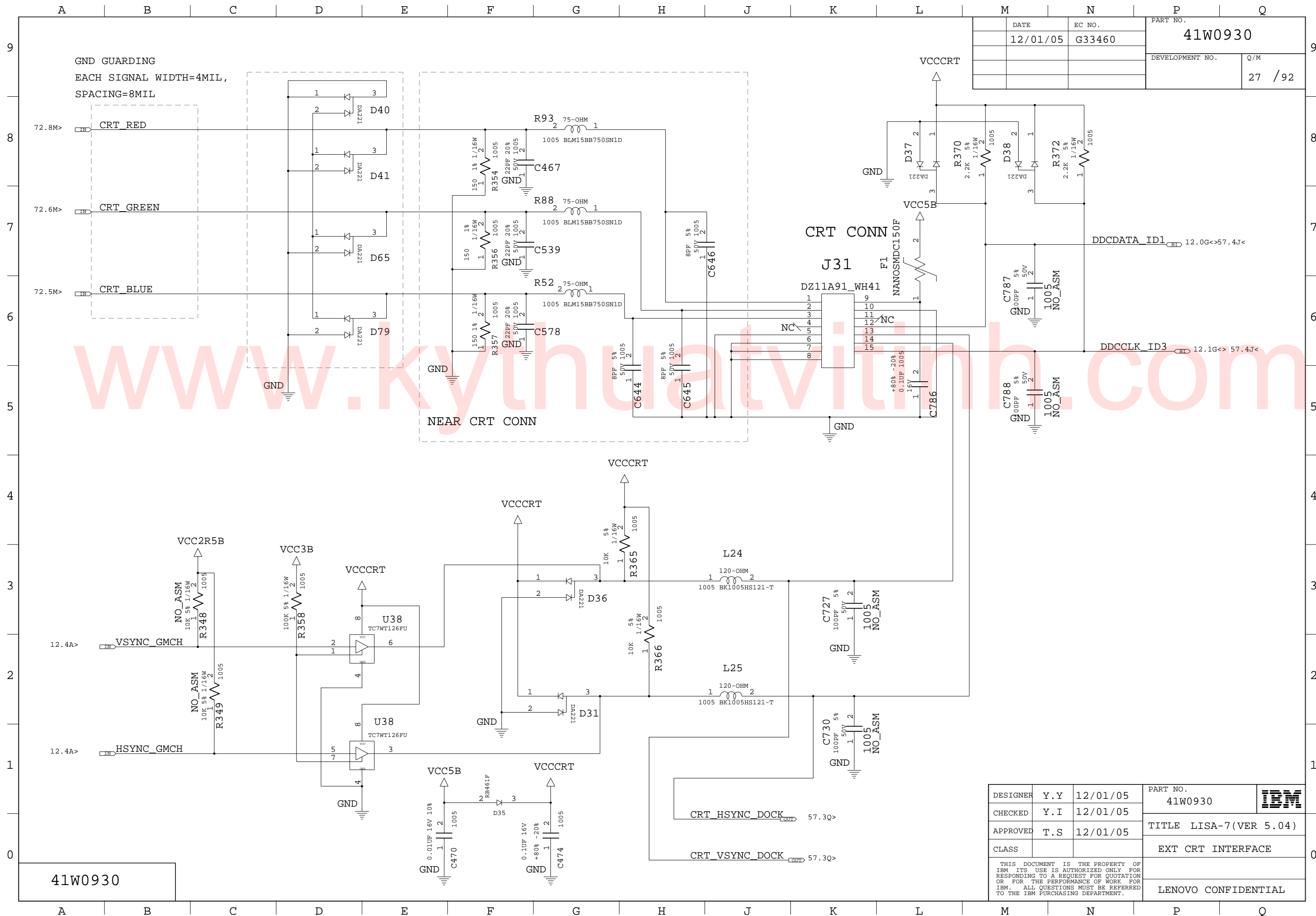

DATE	EC NO.	PART NO.
12/01/05	G33460	41W0930
DEVELOPMENT NO.		Q/M
		27 / 92

41W0930

DESIGNER	Y.Y	12/01/05	PART NO.	41W0930	
CHECKED	Y.I	12/01/05	TITLE LISA-7(VER 5.04)		
APPROVED	T.S	12/01/05	EXT CRT INTERFACE		
CLASS			LENOVO CONFIDENTIAL		

THIS DOCUMENT IS THE PROPERTY OF IBM ITS USE IS AUTHORIZED ONLY FOR RESPONDING TO A REQUEST FOR QUOTATION OR FOR THE PERFORMANCE OF WORK FOR IBM. ALL QUESTIONS MUST BE REFERRED TO THE IBM PURCHASING DEPARTMENT.

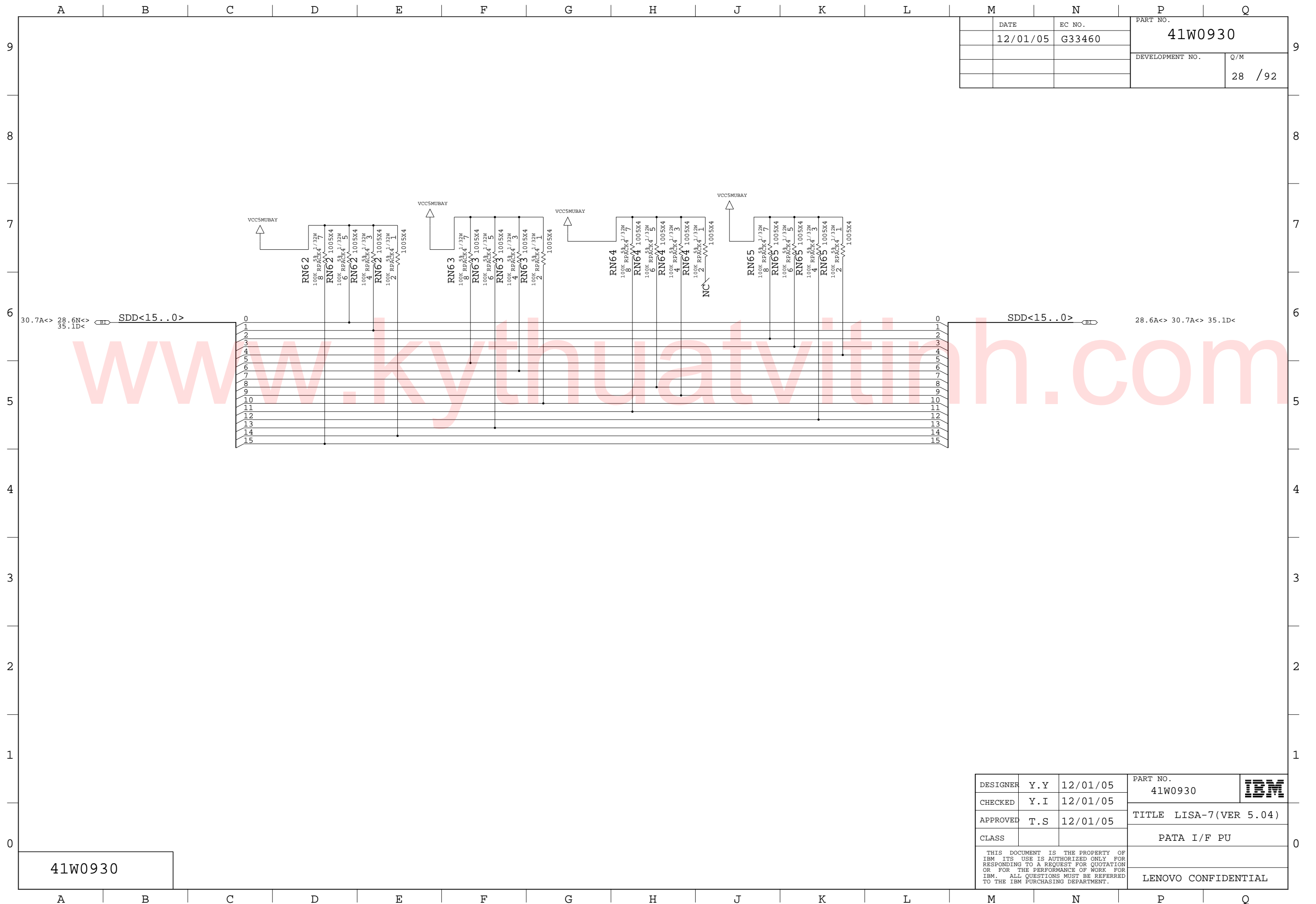

DATE	EC NO.	PART NO.	
12/01/05	G33460	41W0930	
		DEVELOPMENT NO.	Q/M
			28 /92

30.7A<> 28.6N<> 35.1D<> SDD<15..0>

SDD<15..0> 28.6A<> 30.7A<> 35.1D<>

41W0930

DESIGNER	Y.Y	12/01/05	PART NO.	41W0930	IBM
CHECKED	Y.I	12/01/05	TITLE		
APPROVED	T.S	12/01/05	CLASS	PATA I/F PU	
THIS DOCUMENT IS THE PROPERTY OF IBM ITS USE IS AUTHORIZED ONLY FOR RESPONDING TO A REQUEST FOR QUOTATION OR FOR THE PERFORMANCE OF WORK FOR IBM. ALL QUESTIONS MUST BE REFERRED TO THE IBM PURCHASING DEPARTMENT.				LENOVO CONFIDENTIAL	

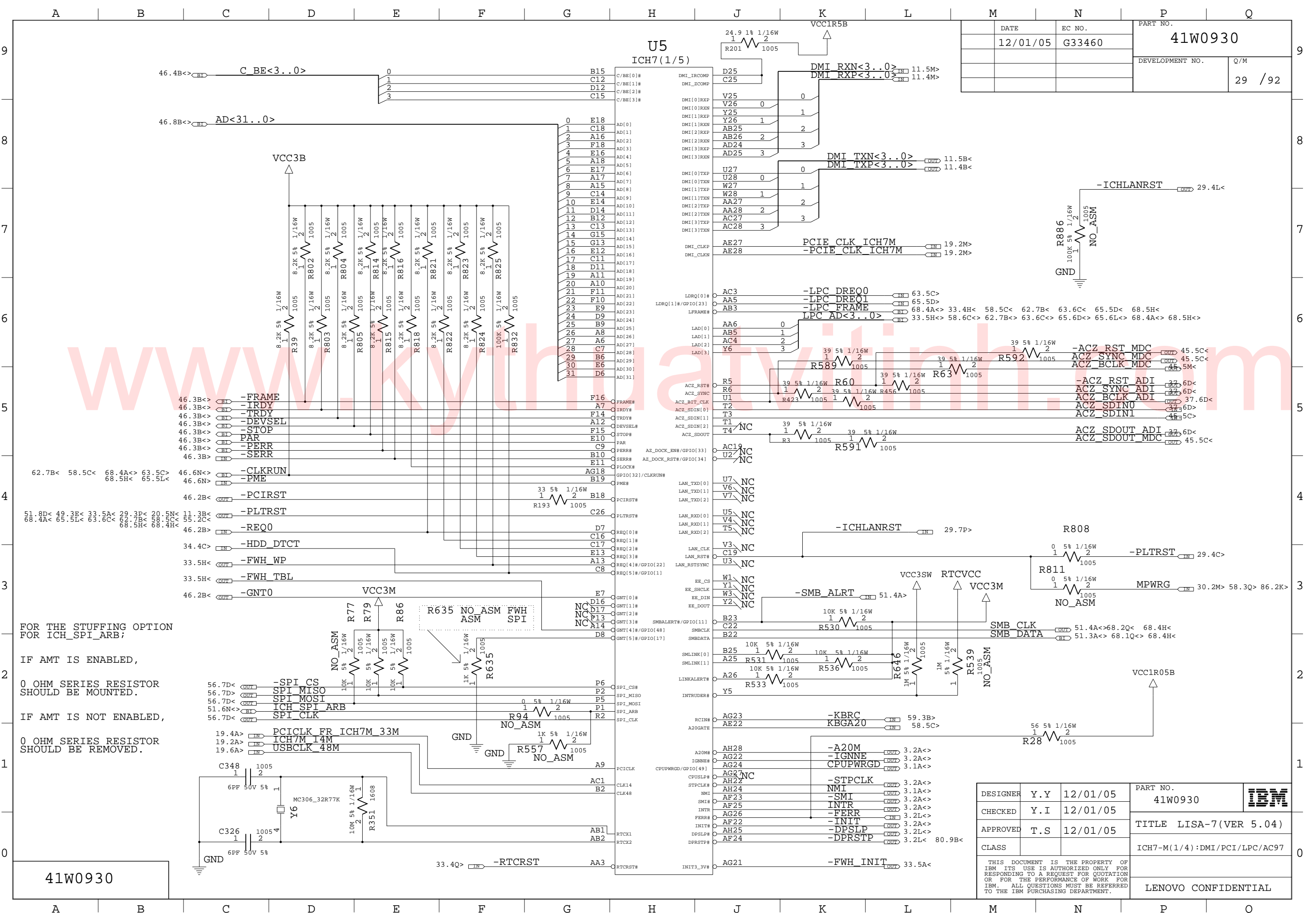

DATE	EC NO.	PART NO.
12/01/05	G33460	41W0930
DEVELOPMENT NO.		Q/M
		29 / 92

FOR THE STUFFING OPTION FOR ICH_SPI_ARB;

IF AMT IS ENABLED, 0 OHM SERIES RESISTOR SHOULD BE MOUNTED.

IF AMT IS NOT ENABLED, 0 OHM SERIES RESISTOR SHOULD BE REMOVED.

DESIGNER	Y.Y	12/01/05	PART NO.	41W0930	
CHECKED	Y.I	12/01/05	TITLE LISA-7(VER 5.04)		
APPROVED	T.S	12/01/05	CLASS ICH7-M(1/4):DMI/PCI/LPC/AC97		
THIS DOCUMENT IS THE PROPERTY OF IBM ITS USE IS AUTHORIZED ONLY FOR RESPONDING TO A REQUEST FOR QUOTATION OR FOR THE PERFORMANCE OF WORK FOR IBM. ALL QUESTIONS MUST BE REFERRED TO THE IBM PURCHASING DEPARTMENT.					LENOVO CONFIDENTIAL

41W0930

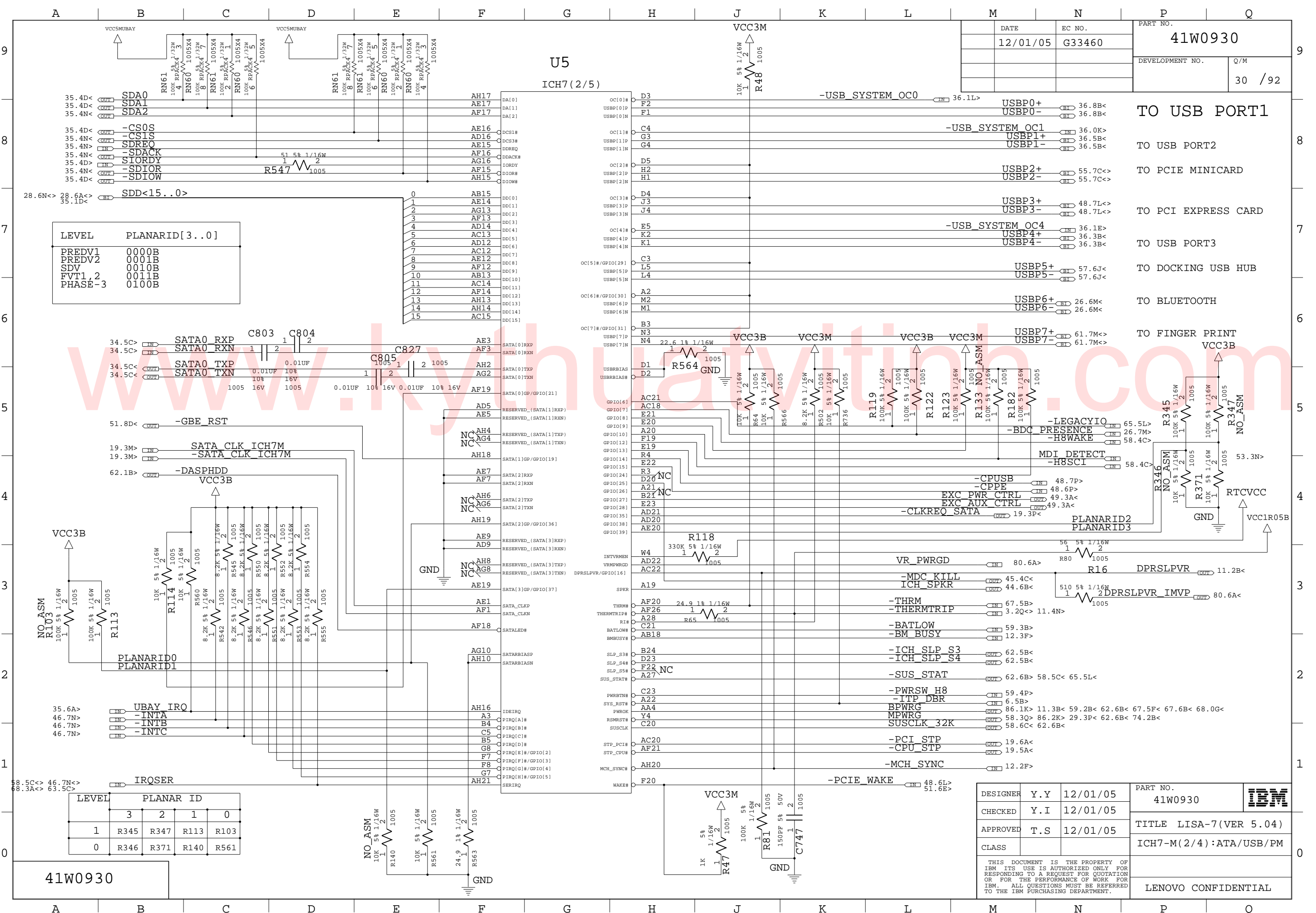

DATE	12/01/05	EC NO.	G33460	PART NO.	41W0930
DEVELOPMENT NO.				Q/M	
				30 / 92	

LEVEL	PLANARID[3..0]
PREDV1	0000B
PREDV2	0001B
SDV	0010B
FVT1,2	0011B
PHASE-3	0100B

LEVEL	PLANARID0	PLANARID1
1	R345	R347
0	R346	R371

LEVEL	PLANAR ID
3	R114
2	R542
1	R546
0	R551

DESIGNER	Y.Y	12/01/05	PART NO.	41W0930	
CHECKED	Y.I	12/01/05	TITLE LISA-7(VER 5.04)		
APPROVED	T.S	12/01/05	ICH7-M(2/4):ATA/USB/PM		LENOVO CONFIDENTIAL
CLASS					

THIS DOCUMENT IS THE PROPERTY OF IBM. ITS USE IS AUTHORIZED ONLY FOR RESPONDING TO A REQUEST FOR QUOTATION OR FOR THE PERFORMANCE OF WORK FOR IBM. ALL QUESTIONS MUST BE REFERRED TO THE IBM PURCHASING DEPARTMENT.

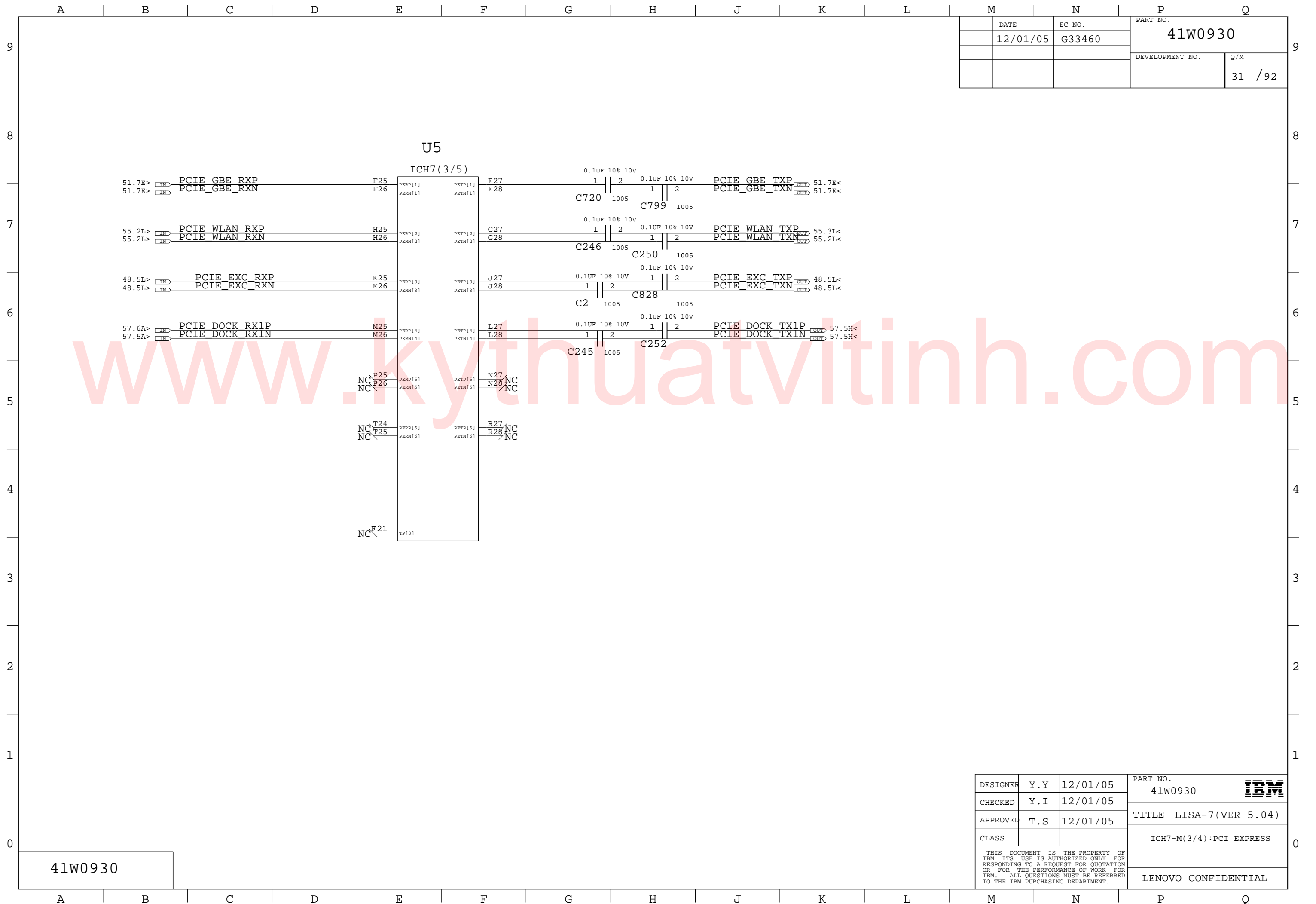

DATE	EC NO.	PART NO.	
12/01/05	G33460	41W0930	
		DEVELOPMENT NO.	Q/M
			31 / 92

U5
ICH7(3/5)

41W0930

DESIGNER	Y.Y	12/01/05	PART NO.	41W0930	IBM
CHECKED	Y.I	12/01/05	TITLE		
APPROVED	T.S	12/01/05	CLASS	ICH7-M(3/4):PCI EXPRESS	
THIS DOCUMENT IS THE PROPERTY OF IBM ITS USE IS AUTHORIZED ONLY FOR RESPONDING TO A REQUEST FOR QUOTATION OR FOR THE PERFORMANCE OF WORK FOR IBM. ALL QUESTIONS MUST BE REFERRED TO THE IBM PURCHASING DEPARTMENT.				LENOVO CONFIDENTIAL	

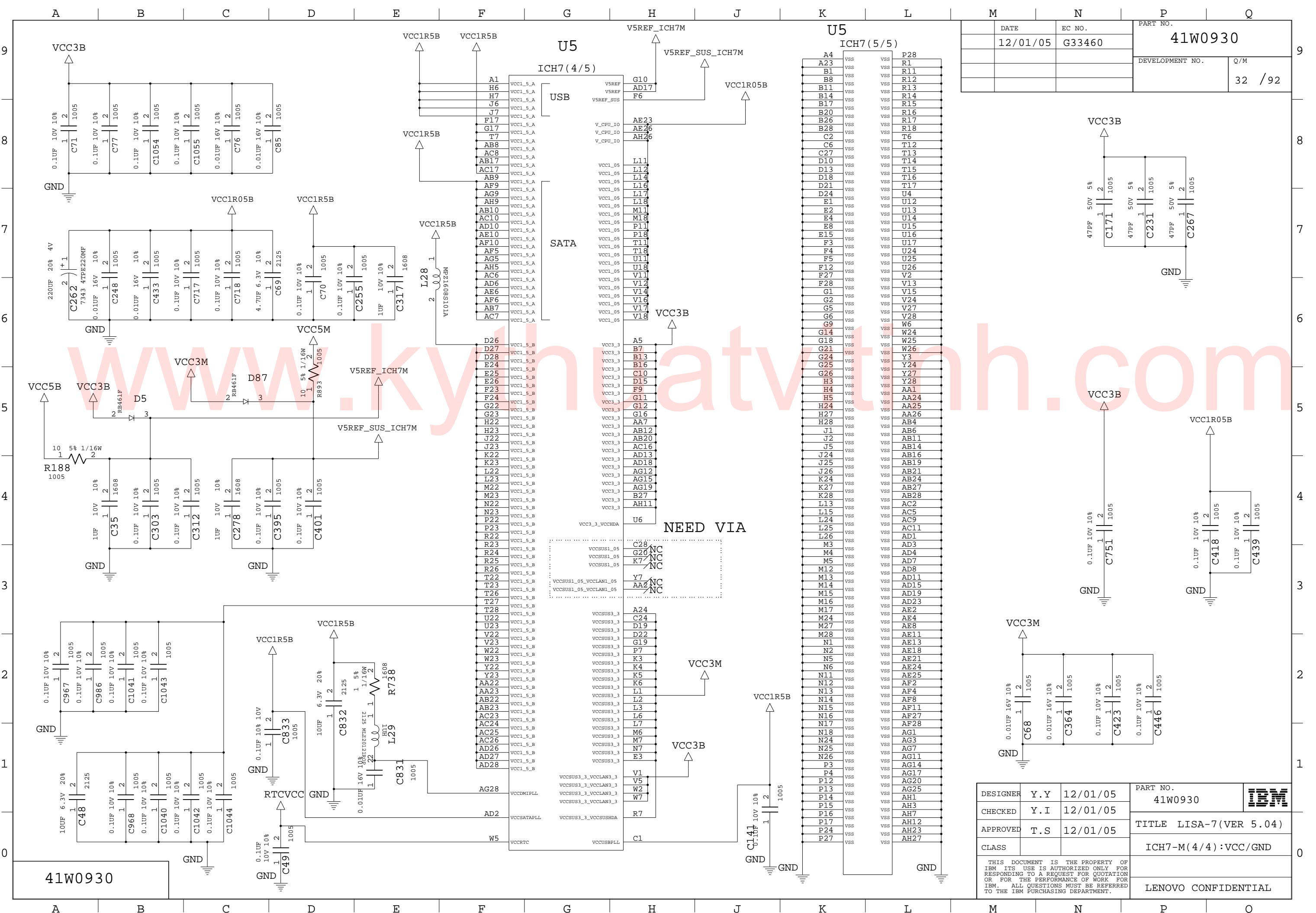

DATE	EC NO.	PART NO.
12/01/05	G33460	41W0930
DEVELOPMENT NO.		Q/M
		32 / 92

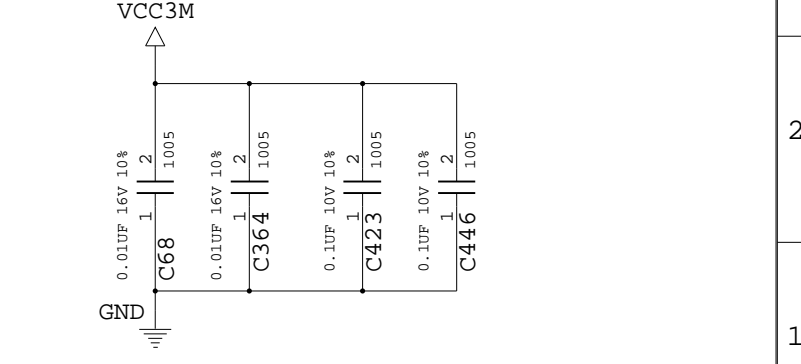
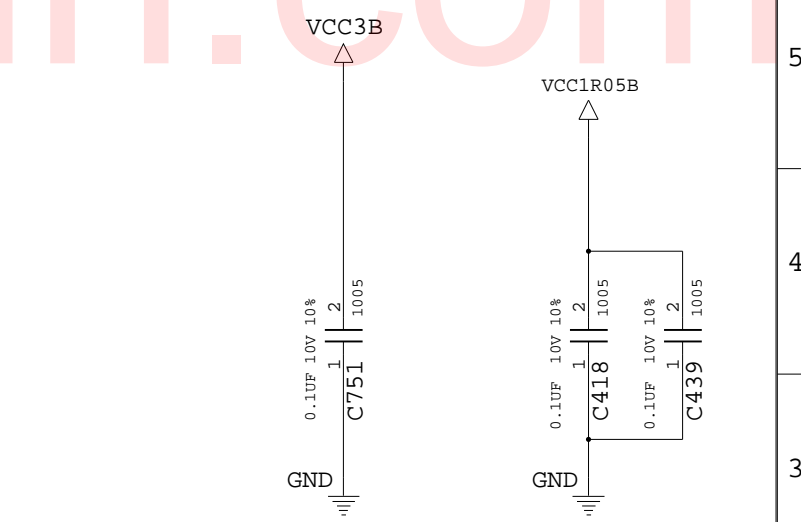
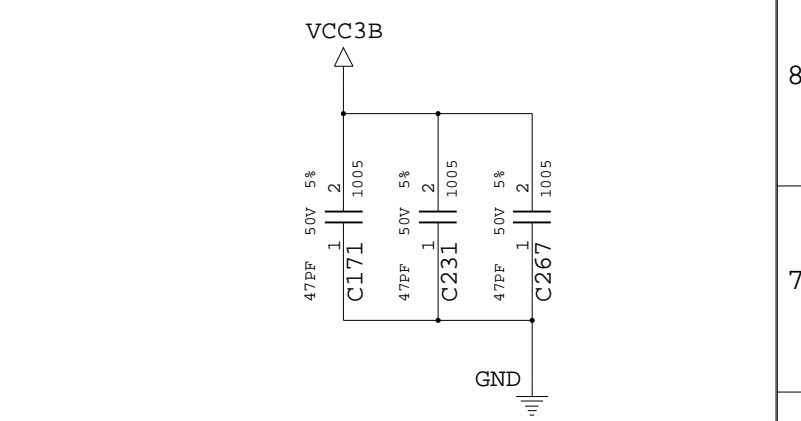

DESIGNER	Y.Y	12/01/05	PART NO.	41W0930	
CHECKED	Y.I	12/01/05	TITLE LISA-7(VER 5.04)		
APPROVED	T.S	12/01/05	CLASS ICH7-M(4/4):VCC/GND		
THIS DOCUMENT IS THE PROPERTY OF IBM ITS USE IS AUTHORIZED ONLY FOR RESPONDING TO A REQUEST FOR QUOTATION OR FOR THE PERFORMANCE OF WORK FOR IBM. ALL QUESTIONS MUST BE REFERRED TO THE IBM PURCHASING DEPARTMENT.					LENOVO CONFIDENTIAL

41W0930

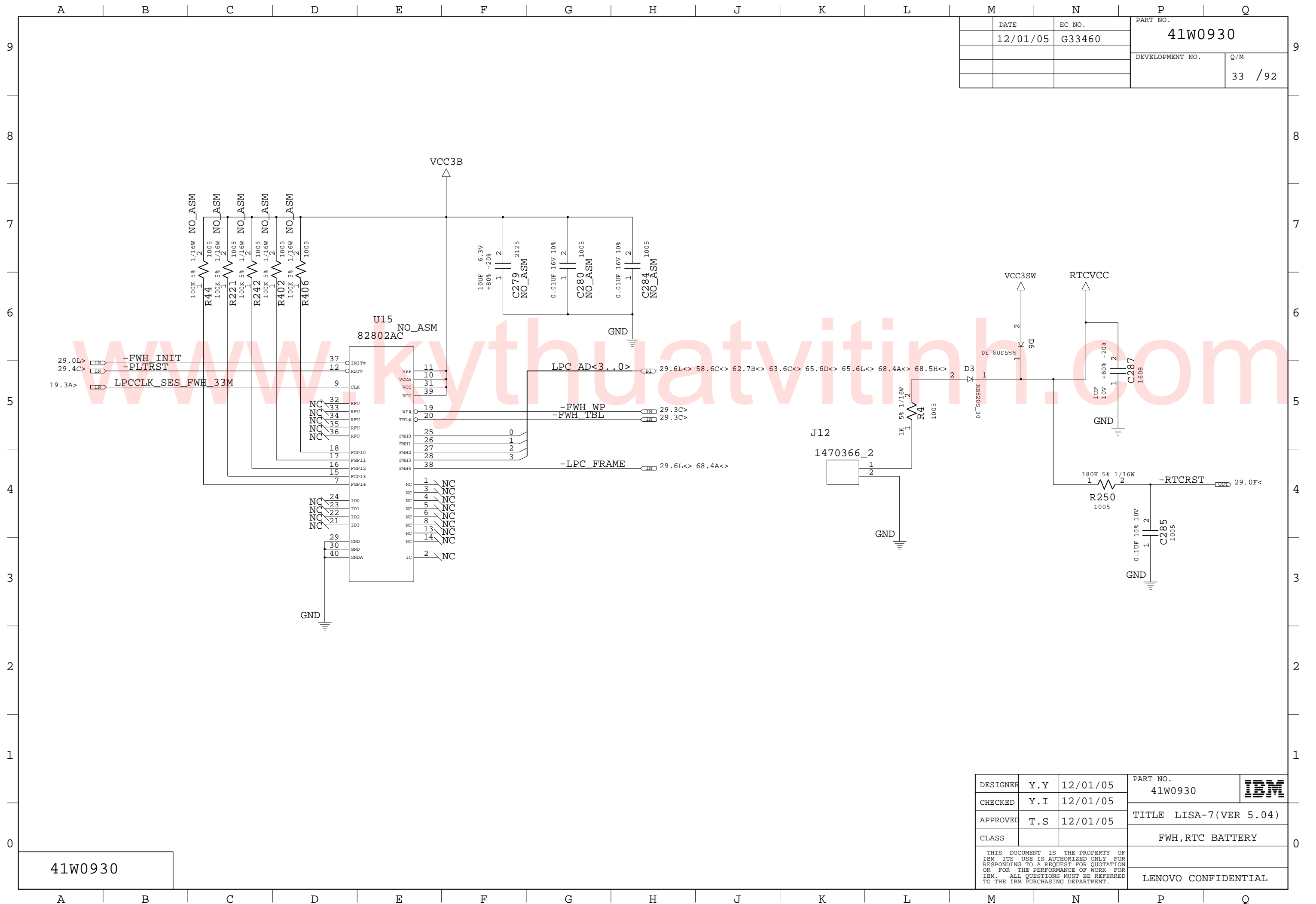

DATE	EC NO.	PART NO.	
12/01/05	G33460	41W0930	
		DEVELOPMENT NO.	Q/M
			33 / 92

41W0930

DESIGNER	Y.Y	12/01/05	PART NO.	41W0930	
CHECKED	Y.I	12/01/05			
APPROVED	T.S	12/01/05	TITLE LISA-7(VER 5.04)		
CLASS			FWH, RTC BATTERY		
THIS DOCUMENT IS THE PROPERTY OF IBM ITS USE IS AUTHORIZED ONLY FOR RESPONDING TO A REQUEST FOR QUOTATION OR FOR THE PERFORMANCE OF WORK FOR IBM. ALL QUESTIONS MUST BE REFERRED TO THE IBM PURCHASING DEPARTMENT.					LENOVO CONFIDENTIAL

	DATE	EC NO.	PART NO.	
	12/01/05	G33460	41W0930	
			DEVELOPMENT NO.	Q/M
				34 / 92

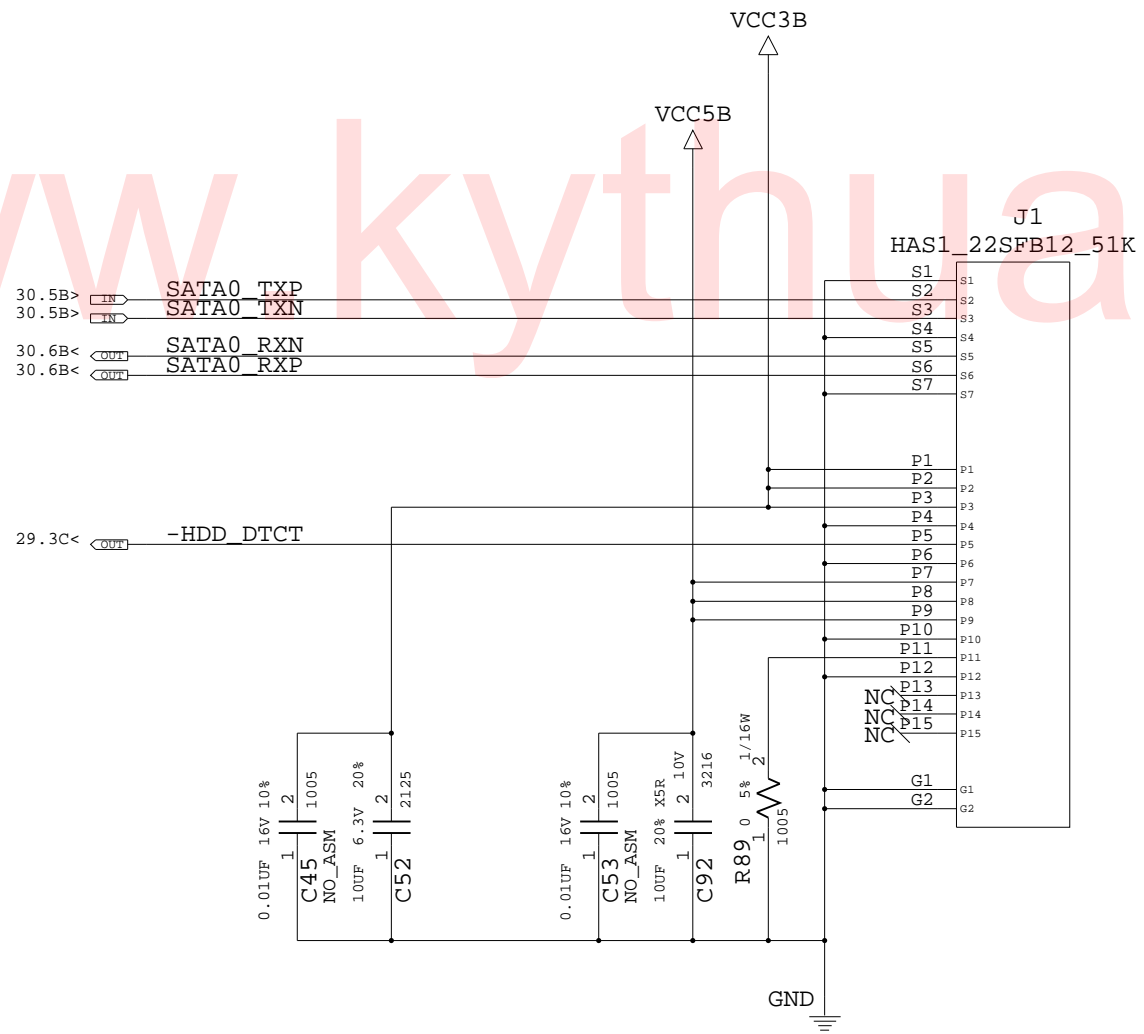

41W0930

DESIGNER	Y.Y	12/01/05	PART NO.	41W0930	
CHECKED	Y.I	12/01/05			
APPROVED	T.S	12/01/05	TITLE LISA-7(VER 5.04)		
CLASS			SATA HDD CONN		
THIS DOCUMENT IS THE PROPERTY OF IBM ITS USE IS AUTHORIZED ONLY FOR RESPONDING TO A REQUEST FOR QUOTATION OR FOR THE PERFORMANCE OF WORK FOR IBM. ALL QUESTIONS MUST BE REFERRED TO THE IBM PURCHASING DEPARTMENT.					LENOVO CONFIDENTIAL

DATE	12/01/05	EC NO.	G33460	PART NO.	41W0930
				DEVELOPMENT NO.	Q/M
				35 / 92	

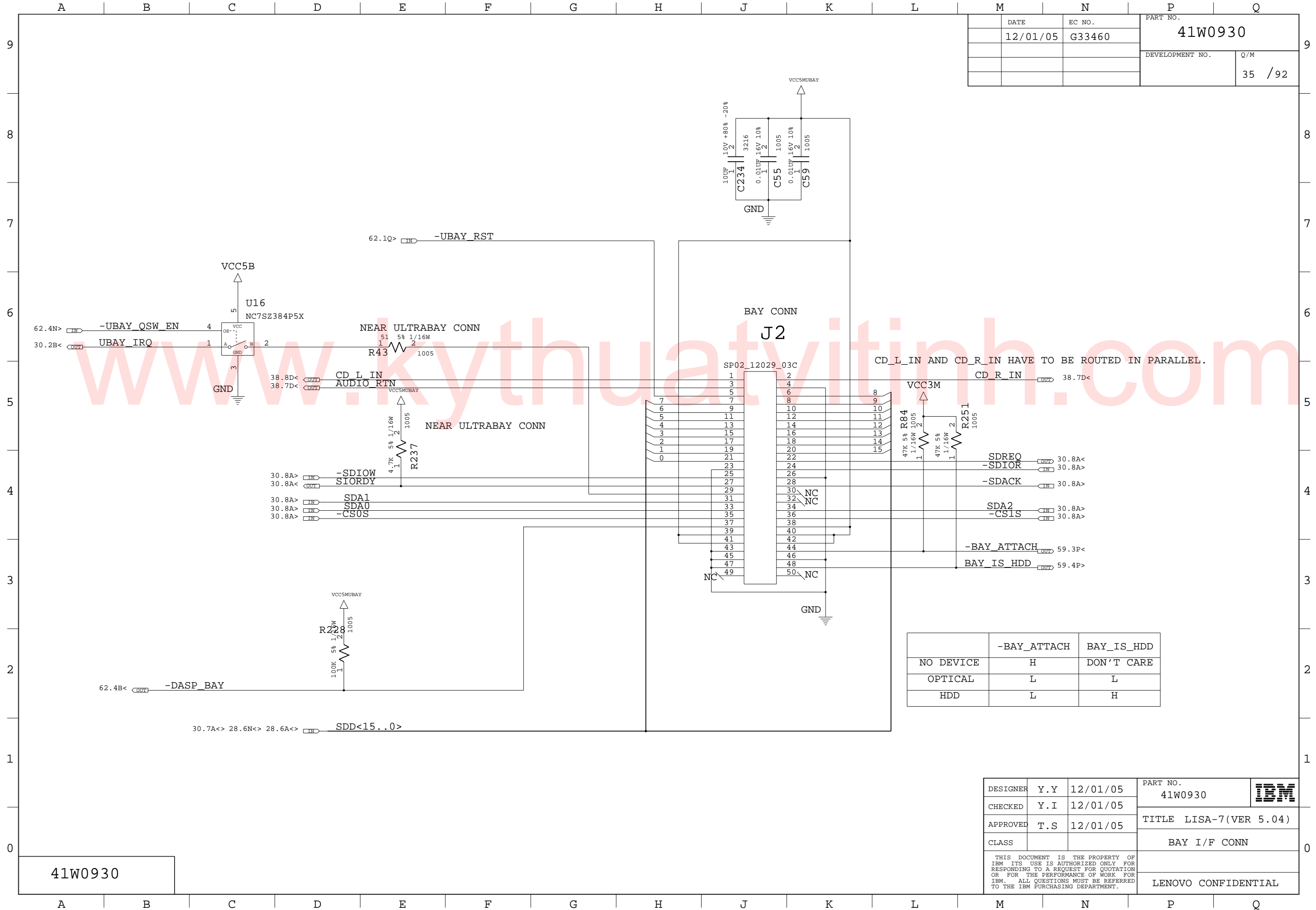

CD_L_IN AND CD_R_IN HAVE TO BE ROUTED IN PARALLEL.

	-BAY_ATTACH	BAY_IS_HDD
NO DEVICE	H	DON'T CARE
OPTICAL	L	L
HDD	L	H

DESIGNER	Y.Y	12/01/05	PART NO.	41W0930	IBM
CHECKED	Y.I	12/01/05	TITLE LISA-7(VER 5.04)		
APPROVED	T.S	12/01/05	BAY I/F CONN		LENOVO CONFIDENTIAL
CLASS	THIS DOCUMENT IS THE PROPERTY OF IBM ITS USE IS AUTHORIZED ONLY FOR RESPONDING TO A REQUEST FOR QUOTATION OR FOR THE PERFORMANCE OF WORK FOR IBM. ALL QUESTIONS MUST BE REFERRED TO THE IBM PURCHASING DEPARTMENT.				

41W0930

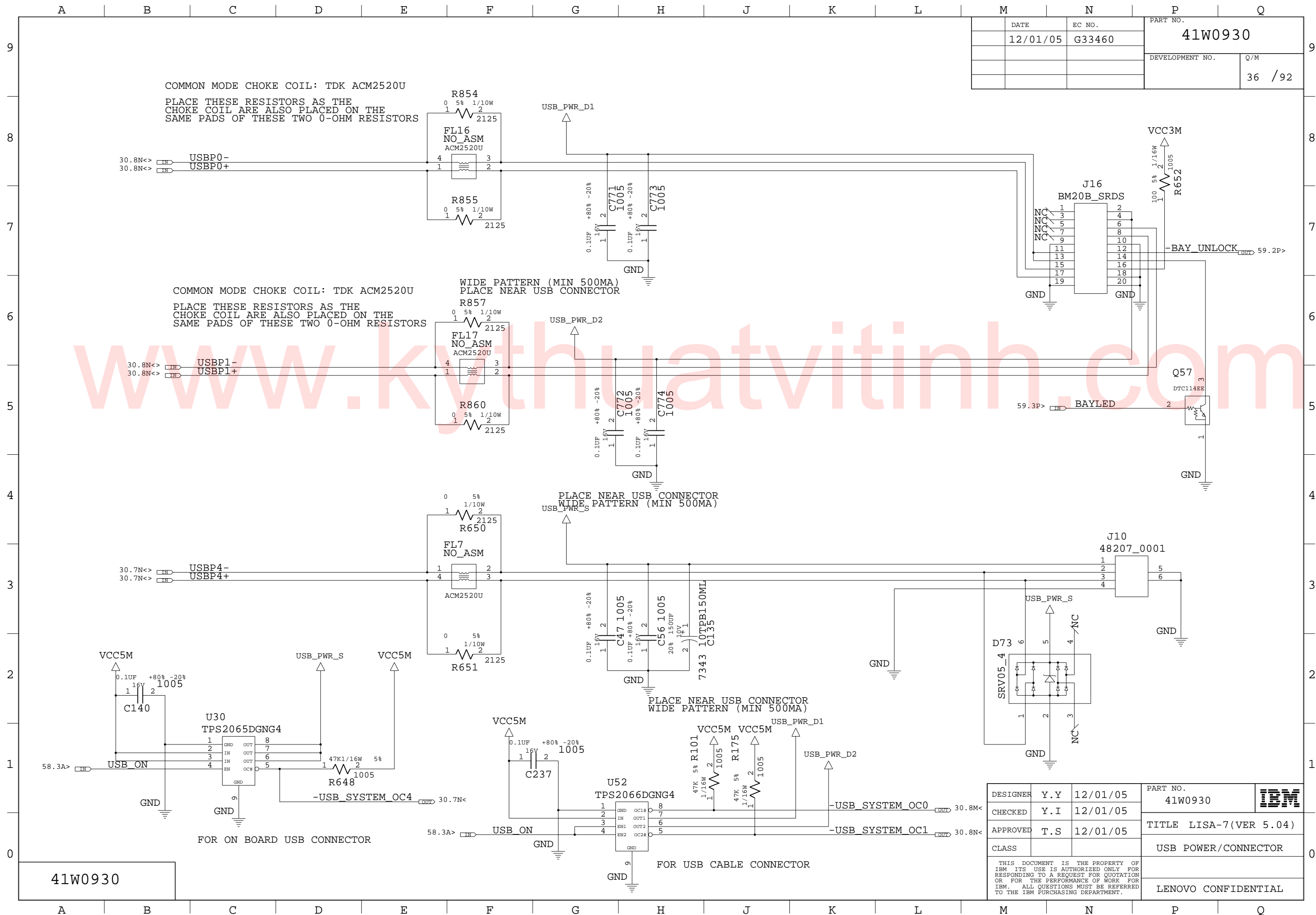

DATE	EC NO.	PART NO.
12/01/05	G33460	41W0930
DEVELOPMENT NO.		Q/M
		36 / 92

41W0930

DESIGNER	Y.Y	12/01/05	PART NO.	41W0930	
CHECKED	Y.I	12/01/05	TITLE LISA-7(VER 5.04)		
APPROVED	T.S	12/01/05	CLASS		USB POWER/CONNECTOR
THIS DOCUMENT IS THE PROPERTY OF IBM ITS USE IS AUTHORIZED ONLY FOR RESPONDING TO A REQUEST FOR QUOTATION OR FOR THE PERFORMANCE OF WORK FOR IBM. ALL QUESTIONS MUST BE REFERRED TO THE IBM PURCHASING DEPARTMENT.					LENOVO CONFIDENTIAL

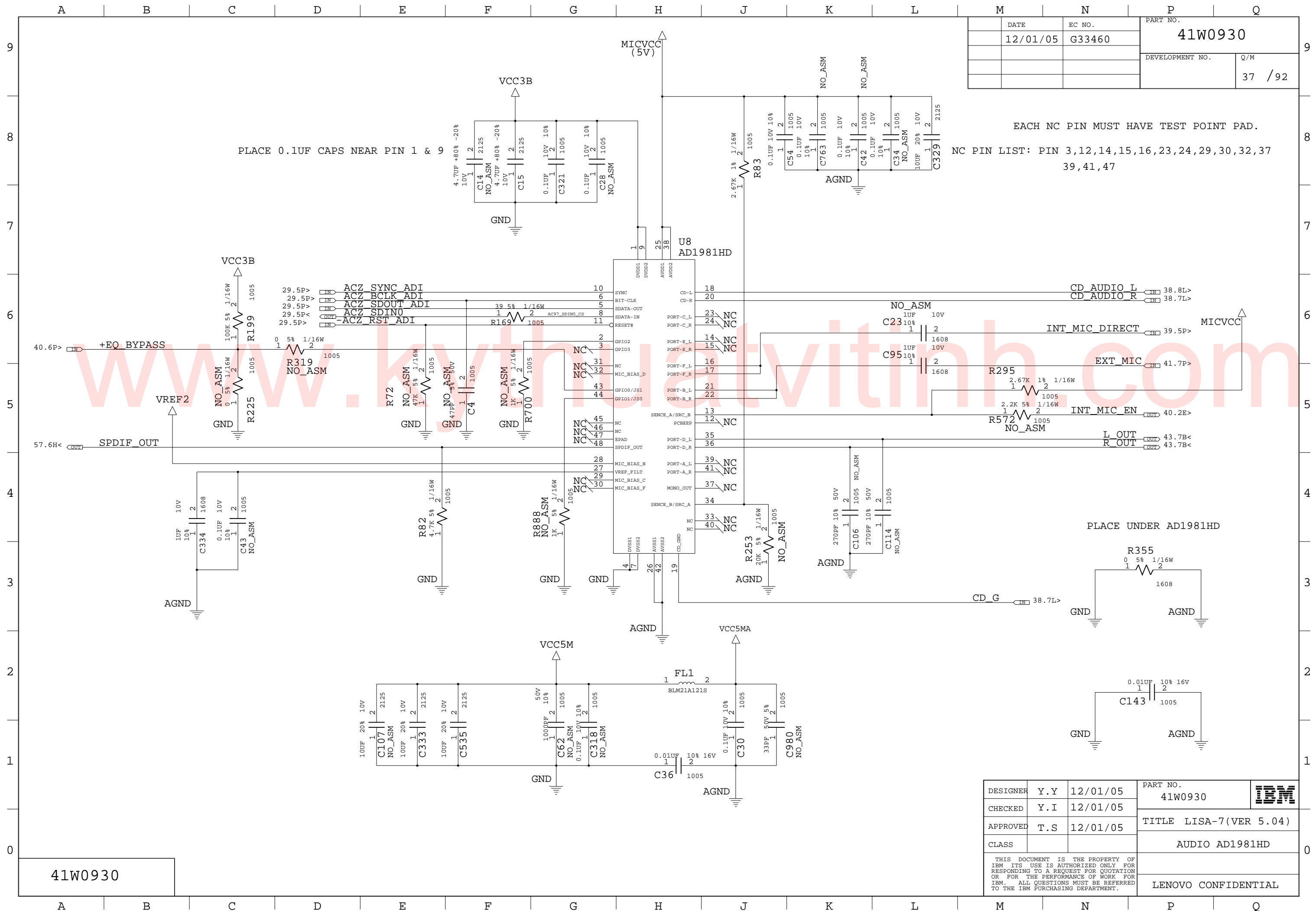

DATE	EC NO.	PART NO.
12/01/05	G33460	41W0930
		DEVELOPMENT NO.
		Q/M
		37 / 92

DESIGNER	Y.Y	12/01/05	PART NO.	41W0930	IBM
CHECKED	Y.I	12/01/05	TITLE	LISA-7(VER 5.04)	
APPROVED	T.S	12/01/05		AUDIO AD1981HD	
CLASS					
THIS DOCUMENT IS THE PROPERTY OF IBM ITS USE IS AUTHORIZED ONLY FOR RESPONDING TO A REQUEST FOR QUOTATION OR FOR THE PERFORMANCE OF WORK FOR IBM. ALL QUESTIONS MUST BE REFERRED TO THE IBM PURCHASING DEPARTMENT.					LENOVO CONFIDENTIAL

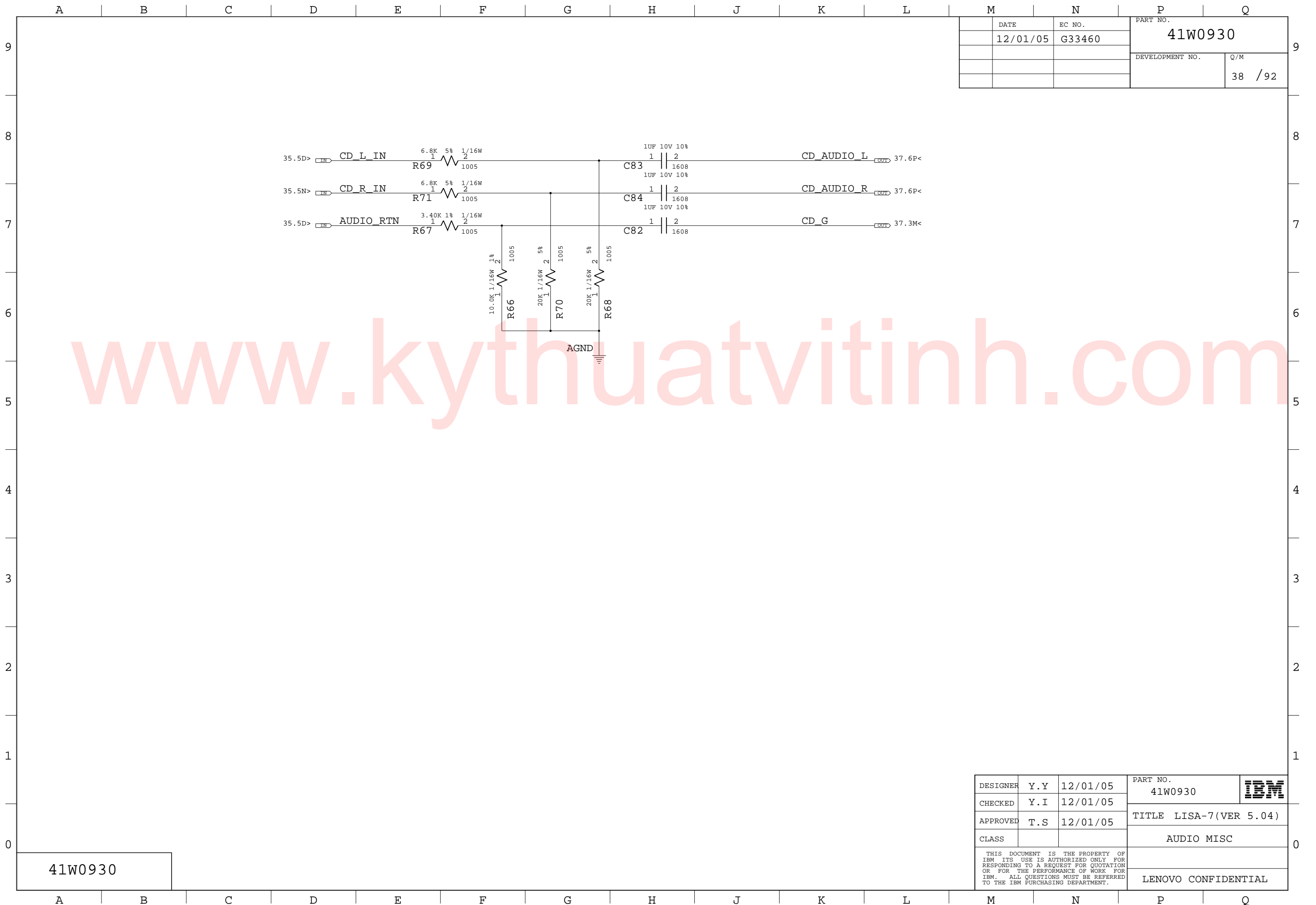

DATE	EC NO.	PART NO.	
12/01/05	G33460	41W0930	
		DEVELOPMENT NO.	Q/M
			38 / 92

www.kythuatvithinh.com

41W0930

DESIGNER	Y.Y	12/01/05	PART NO.	41W0930	IBM
CHECKED	Y.I	12/01/05			
APPROVED	T.S	12/01/05	TITLE LISA-7(VER 5.04)		
CLASS			AUDIO MISC		
THIS DOCUMENT IS THE PROPERTY OF IBM ITS USE IS AUTHORIZED ONLY FOR RESPONDING TO A REQUEST FOR QUOTATION OR FOR THE PERFORMANCE OF WORK FOR IBM. ALL QUESTIONS MUST BE REFERRED TO THE IBM PURCHASING DEPARTMENT.				LENOVO CONFIDENTIAL	

DATE	EC NO.	PART NO.
12/01/05	G33460	41W0930
DEVELOPMENT NO.		Q/M
		39 / 92

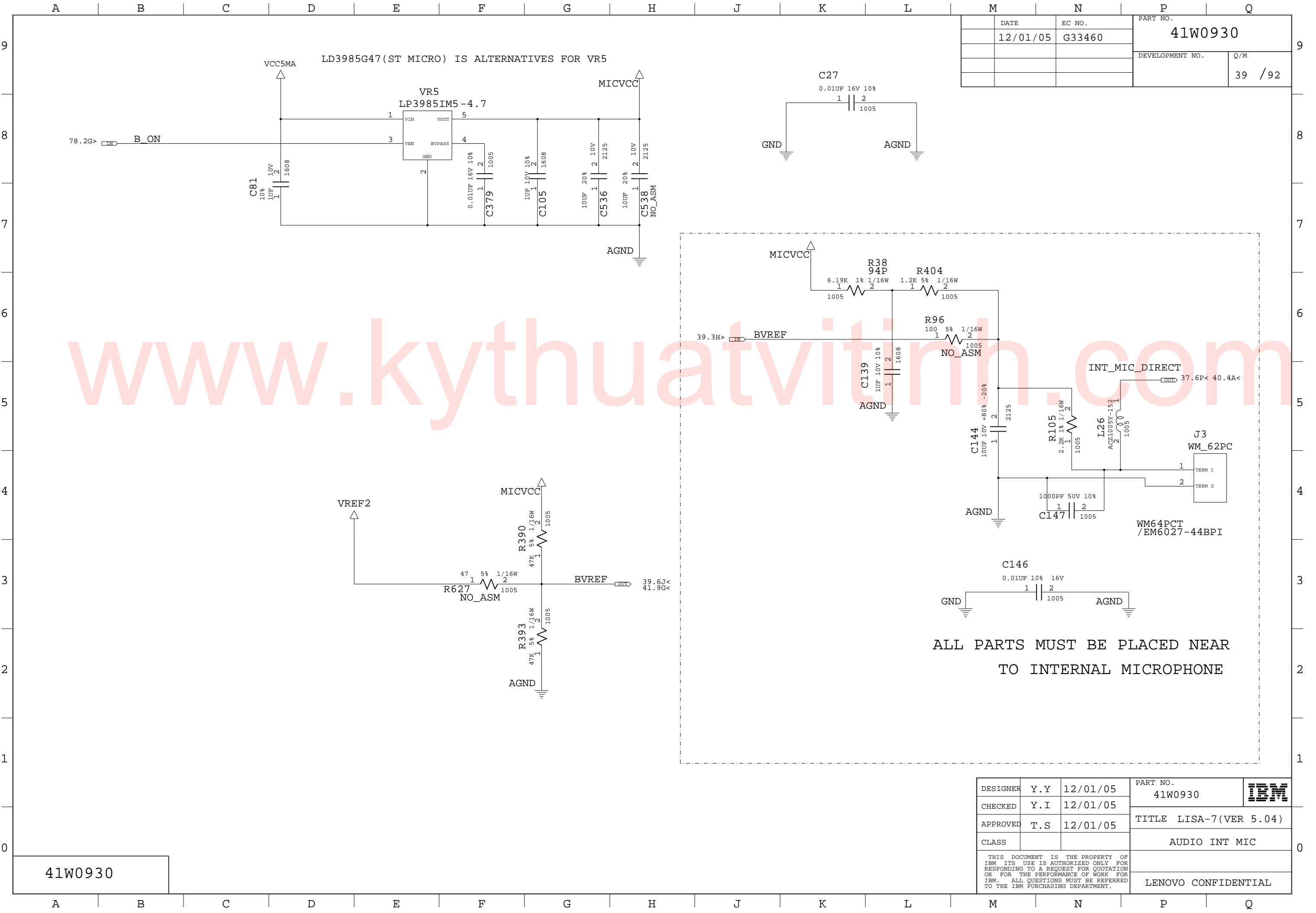

41W0930

DESIGNER	Y.Y	12/01/05	PART NO.	41W0930	IBM
CHECKED	Y.I	12/01/05	TITLE LISA-7(VER 5.04)		
APPROVED	T.S	12/01/05	AUDIO INT MIC		
CLASS			LENOVO CONFIDENTIAL		

THIS DOCUMENT IS THE PROPERTY OF IBM ITS USE IS AUTHORIZED ONLY FOR RESPONDING TO A REQUEST FOR QUOTATION OR FOR THE PERFORMANCE OF WORK FOR IBM. ALL QUESTIONS MUST BE REFERRED TO THE IBM PURCHASING DEPARTMENT.

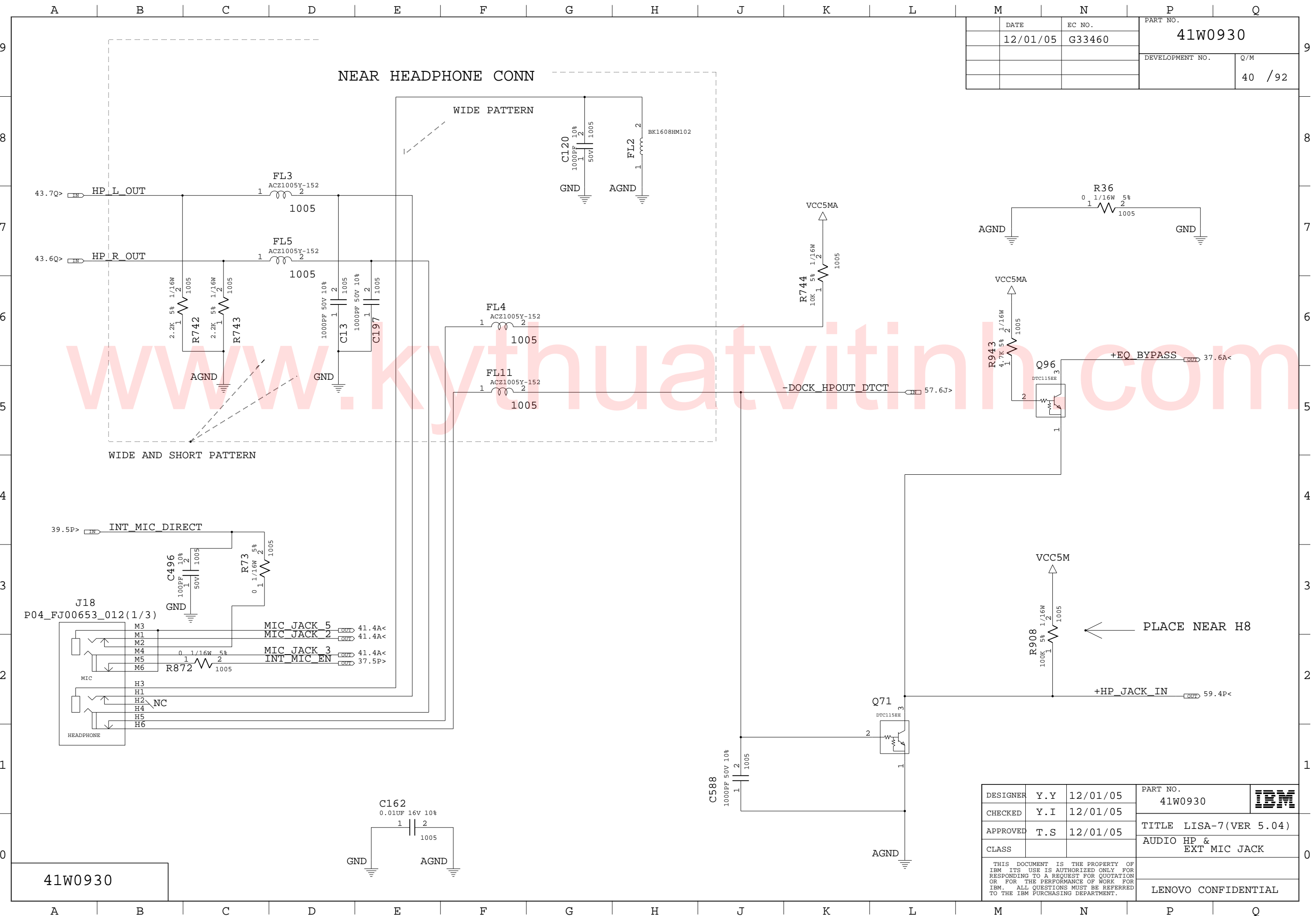

DATE	EC NO.	PART NO.	
12/01/05	G33460	41W0930	
		DEVELOPMENT NO.	Q/M
			40 / 92

41W0930

DESIGNER	Y.Y	12/01/05	PART NO.	41W0930	IBM
CHECKED	Y.I	12/01/05			
APPROVED	T.S	12/01/05	TITLE	LISA-7(VER 5.04)	
CLASS			AUDIO HP & EXT MIC JACK		
THIS DOCUMENT IS THE PROPERTY OF IBM. ITS USE IS AUTHORIZED ONLY FOR RESPONDING TO A REQUEST FOR QUOTATION OR FOR THE PERFORMANCE OF WORK FOR IBM. ALL QUESTIONS MUST BE REFERRED TO THE IBM PURCHASING DEPARTMENT.				LENOVO CONFIDENTIAL	

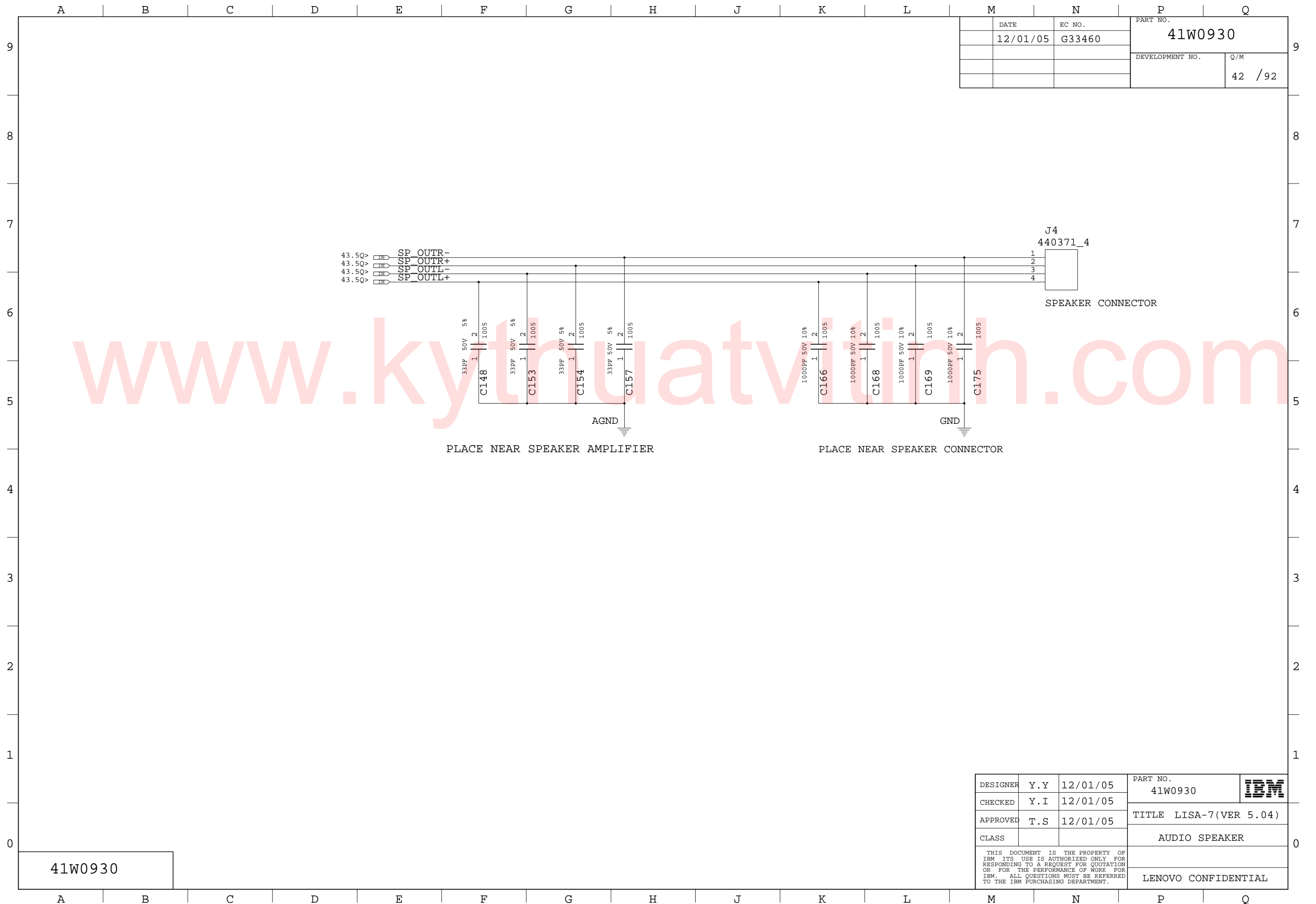

DATE	EC NO.	PART NO.	
12/01/05	G33460	41W0930	
		DEVELOPMENT NO.	Q/M
			42 / 92

41W0930

DESIGNER	Y.Y	12/01/05	PART NO.	41W0930	IBM
CHECKED	Y.I	12/01/05			
APPROVED	T.S	12/01/05	TITLE LISA-7(VER 5.04)		
CLASS			AUDIO SPEAKER		
THIS DOCUMENT IS THE PROPERTY OF IBM ITS USE IS AUTHORIZED ONLY FOR RESPONDING TO A REQUEST FOR QUOTATION OR FOR THE PERFORMANCE OF WORK FOR IBM. ALL QUESTIONS MUST BE REFERRED TO THE IBM PURCHASING DEPARTMENT.				LENOVO CONFIDENTIAL	

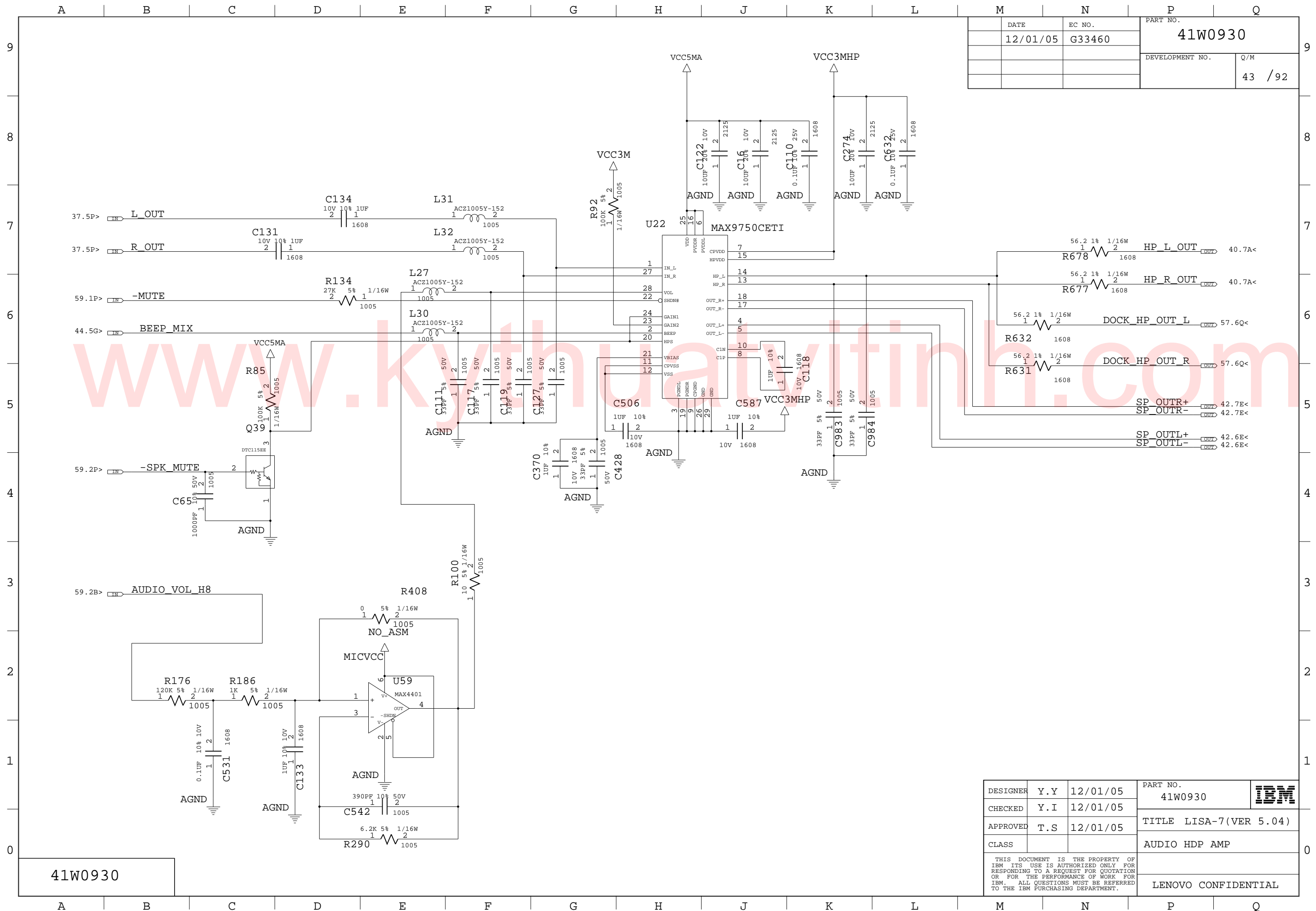

DATE	EC NO.	PART NO.	
12/01/05	G33460	41W0930	
		DEVELOPMENT NO.	Q/M
			43 / 92

41W0930

DESIGNER	Y.Y	12/01/05	PART NO.	41W0930	
CHECKED	Y.I	12/01/05	TITLE		
APPROVED	T.S	12/01/05	CLASS	AUDIO HDP AMP	
THIS DOCUMENT IS THE PROPERTY OF IBM. ITS USE IS AUTHORIZED ONLY FOR RESPONDING TO A REQUEST FOR QUOTATION OR FOR THE PERFORMANCE OF WORK FOR IBM. ALL QUESTIONS MUST BE REFERRED TO THE IBM PURCHASING DEPARTMENT.					LENOVO CONFIDENTIAL

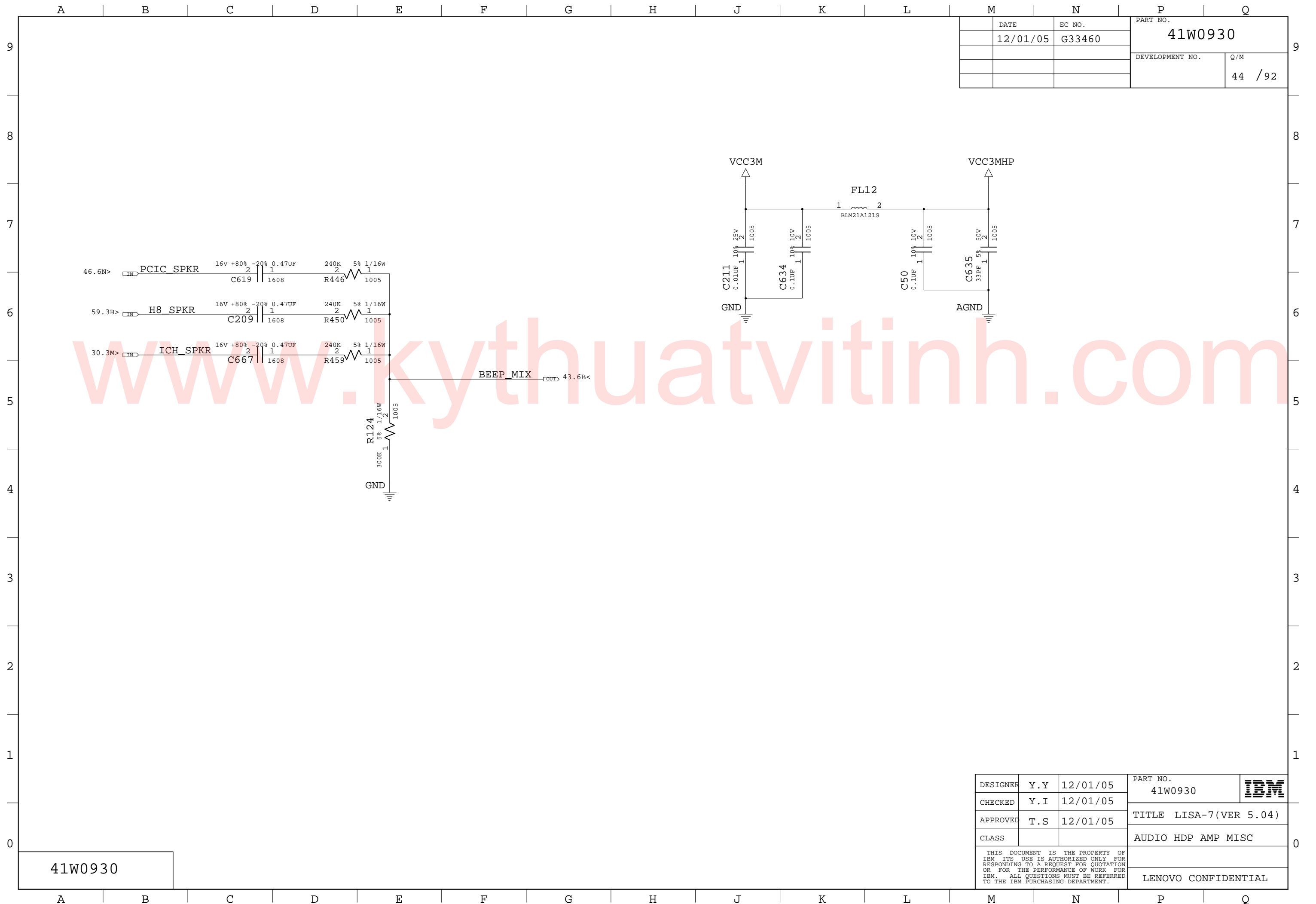

	DATE	EC NO.	PART NO.	
	12/01/05	G33460	41W0930	
			DEVELOPMENT NO.	Q/M
				45 / 92

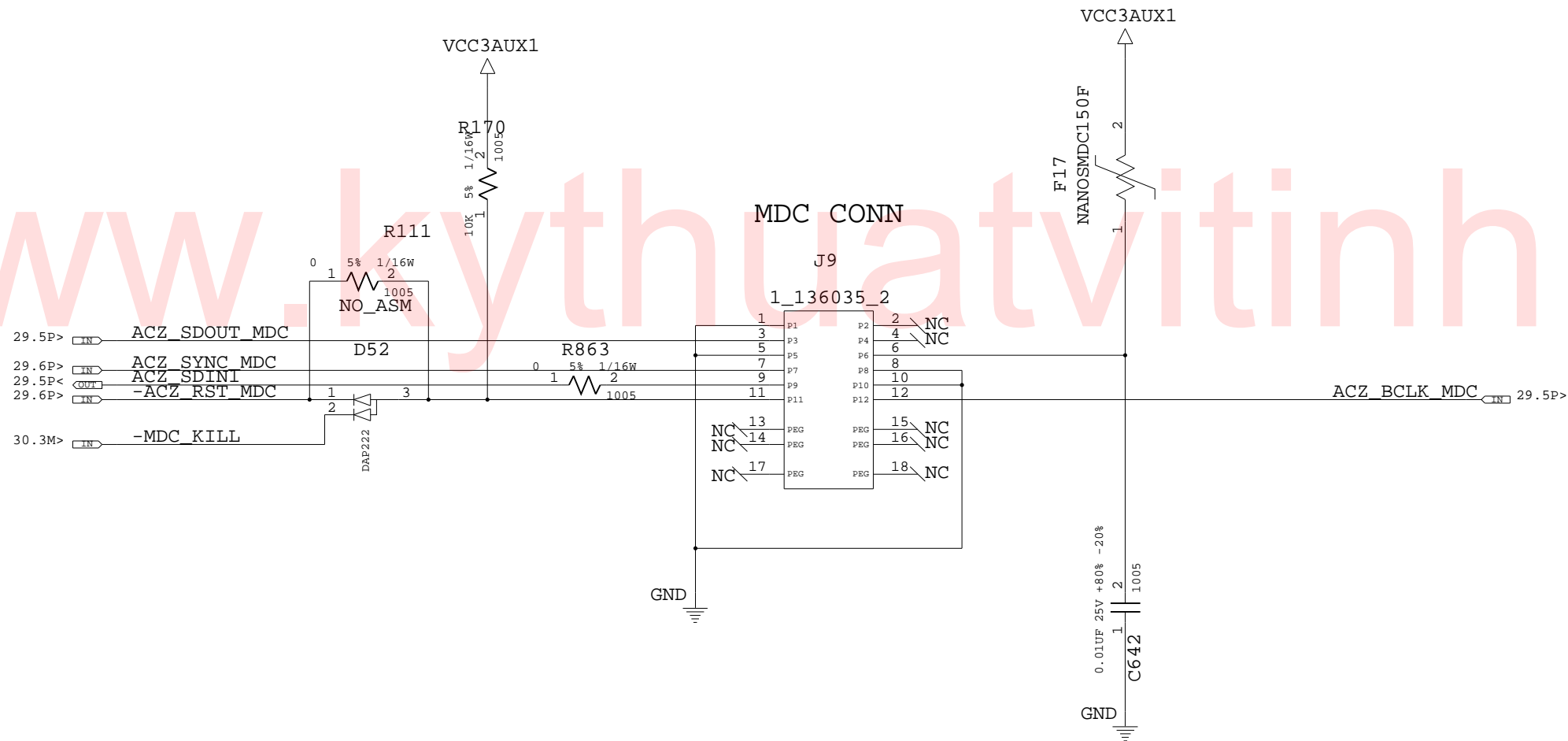

41W0930

DESIGNER	Y.Y	12/01/05	PART NO.	41W0930	
CHECKED	Y.I	12/01/05	TITLE LISA-7(VER 5.04)		
APPROVED	T.S	12/01/05	MDC 1.5 CONNECTOR		
CLASS			THIS DOCUMENT IS THE PROPERTY OF IBM ITS USE IS AUTHORIZED ONLY FOR RESPONDING TO A REQUEST FOR QUOTATION OR FOR THE PERFORMANCE OF WORK FOR IBM. ALL QUESTIONS MUST BE REFERRED TO THE IBM PURCHASING DEPARTMENT.		
					LENOVO CONFIDENTIAL

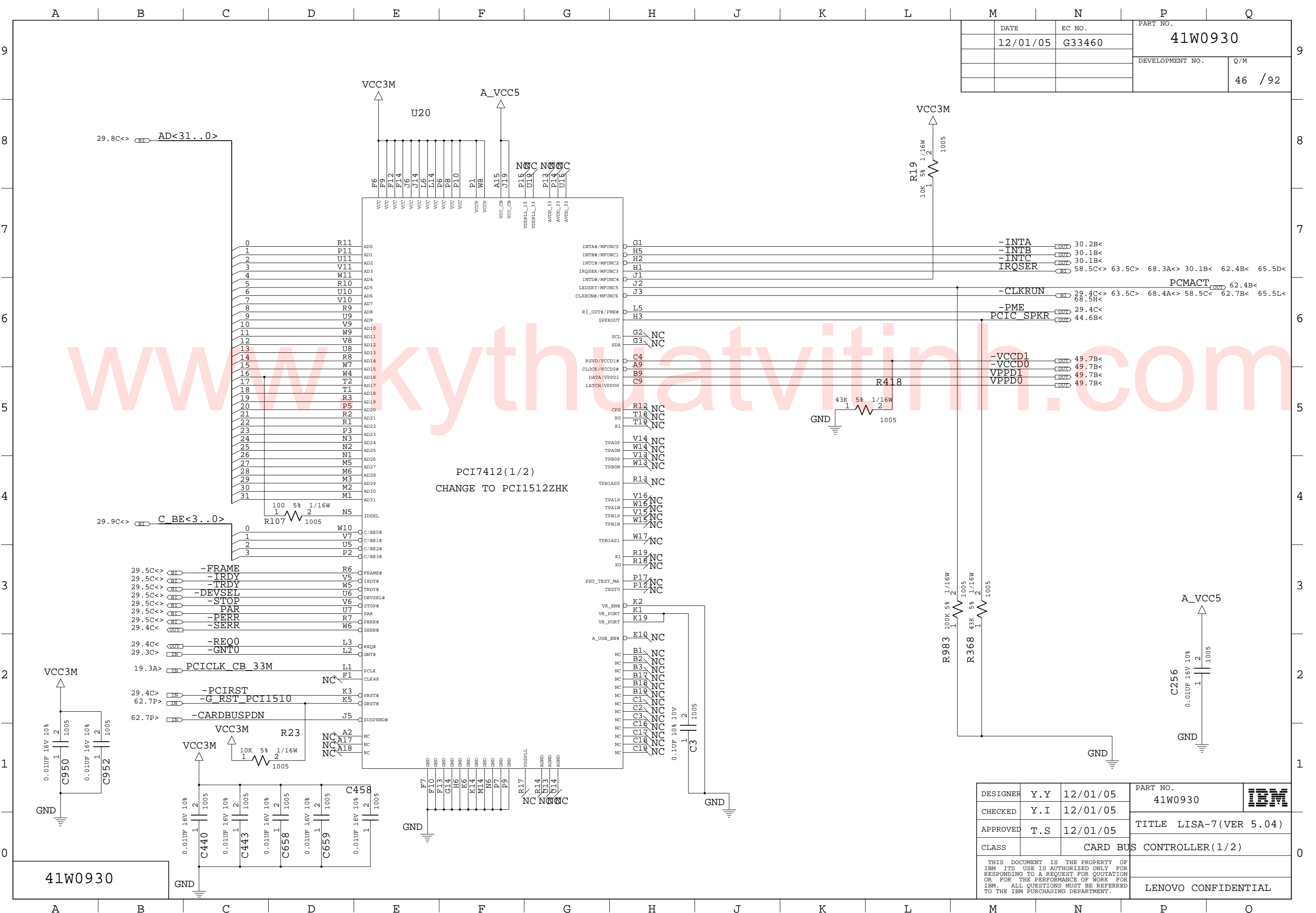

DATE	EC NO.	PART NO.	
12/01/05	G33460	41W0930	
		DEVELOPMENT NO.	Q/M
			46 / 92

PCI7412(1/2)
CHANGE TO PCI1512ZHK

41W0930

DESIGNER	Y.Y	12/01/05	PART NO.	41W0930	IBM
CHECKED	Y.I	12/01/05			
APPROVED	T.S	12/01/05	TITLE LISA-7(VER 5.04)		
CLASS			CARD BUS CONTROLLER(1/2)		
THIS DOCUMENT IS THE PROPERTY OF IBM. ITS USE IS AUTHORIZED ONLY FOR RESPONDING TO A REQUEST FOR QUOTATION OR FOR THE PERFORMANCE OF WORK FOR IBM. ALL QUESTIONS MUST BE REFERRED TO THE IBM PURCHASING DEPARTMENT.					LENOVO CONFIDENTIAL

DATE	EC NO.	PART NO.	
12/01/05	G33460	41W0930	
		DEVELOPMENT NO.	Q/M
			47 / 92

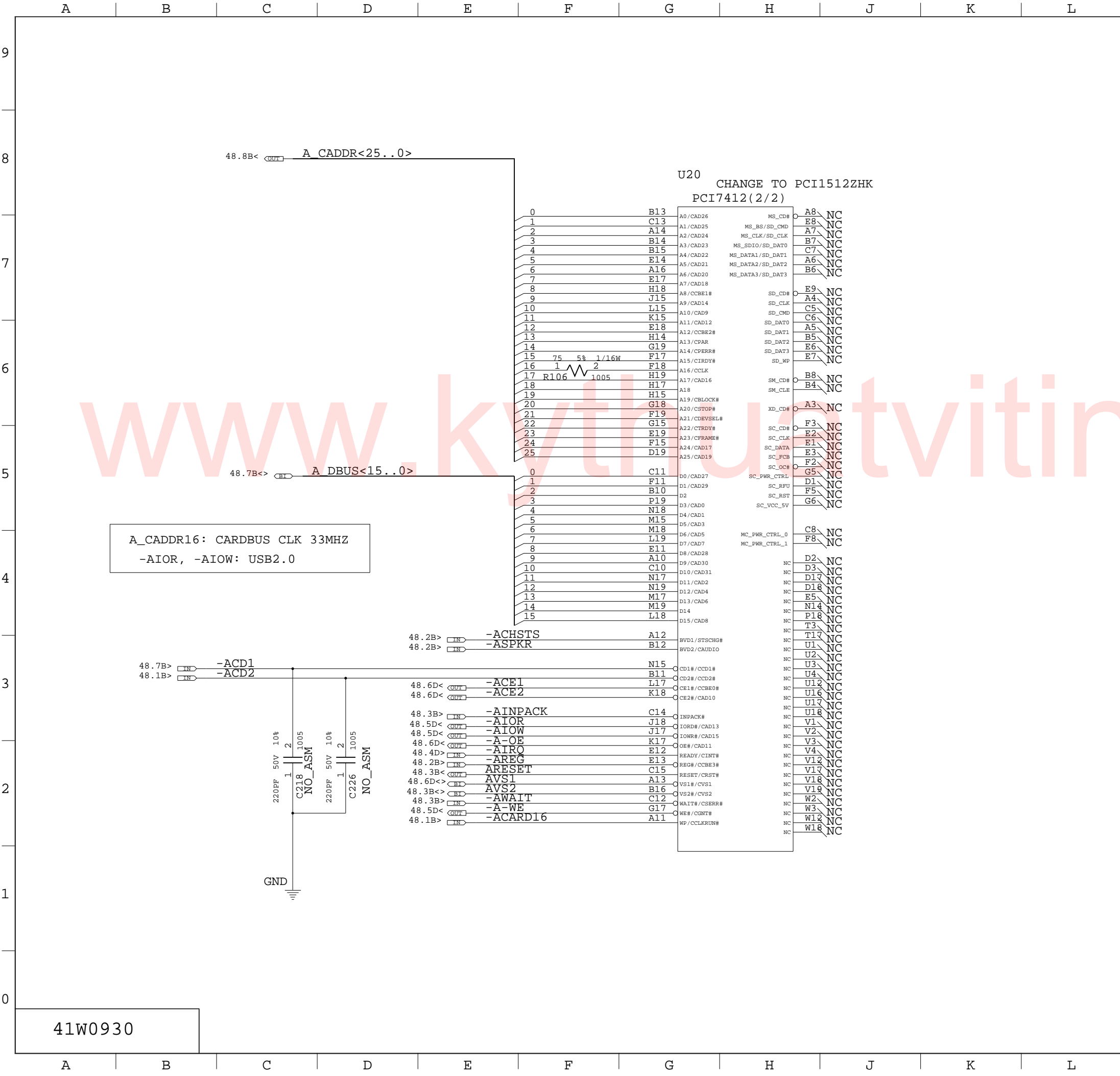

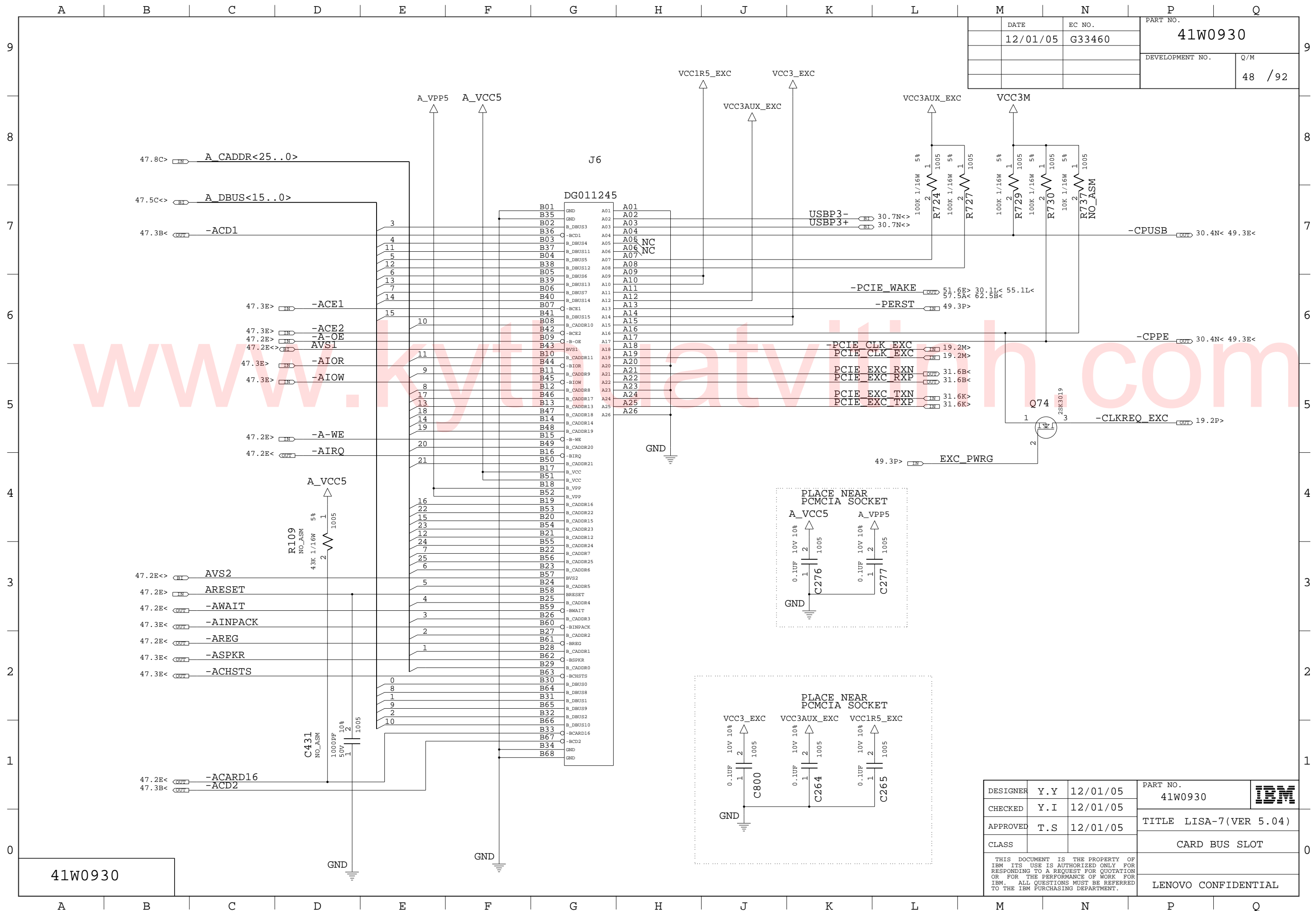

DATE	EC NO.	PART NO.
12/01/05	G33460	41W0930
DEVELOPMENT NO.		Q/M
		48 / 92

DESIGNER	Y.Y	12/01/05	PART NO.	41W0930	
CHECKED	Y.I	12/01/05	TITLE		
APPROVED	T.S	12/01/05	CARD BUS SLOT		
CLASS					
THIS DOCUMENT IS THE PROPERTY OF IBM. ITS USE IS AUTHORIZED ONLY FOR RESPONDING TO A REQUEST FOR QUOTATION OR FOR THE PERFORMANCE OF WORK FOR IBM. ALL QUESTIONS MUST BE REFERRED TO THE IBM PURCHASING DEPARTMENT.					LENOVO CONFIDENTIAL

41W0930

DATE	EC NO.	PART NO.	
12/01/05	G33460	41W0930	
		DEVELOPMENT NO.	Q/M
			49 / 92

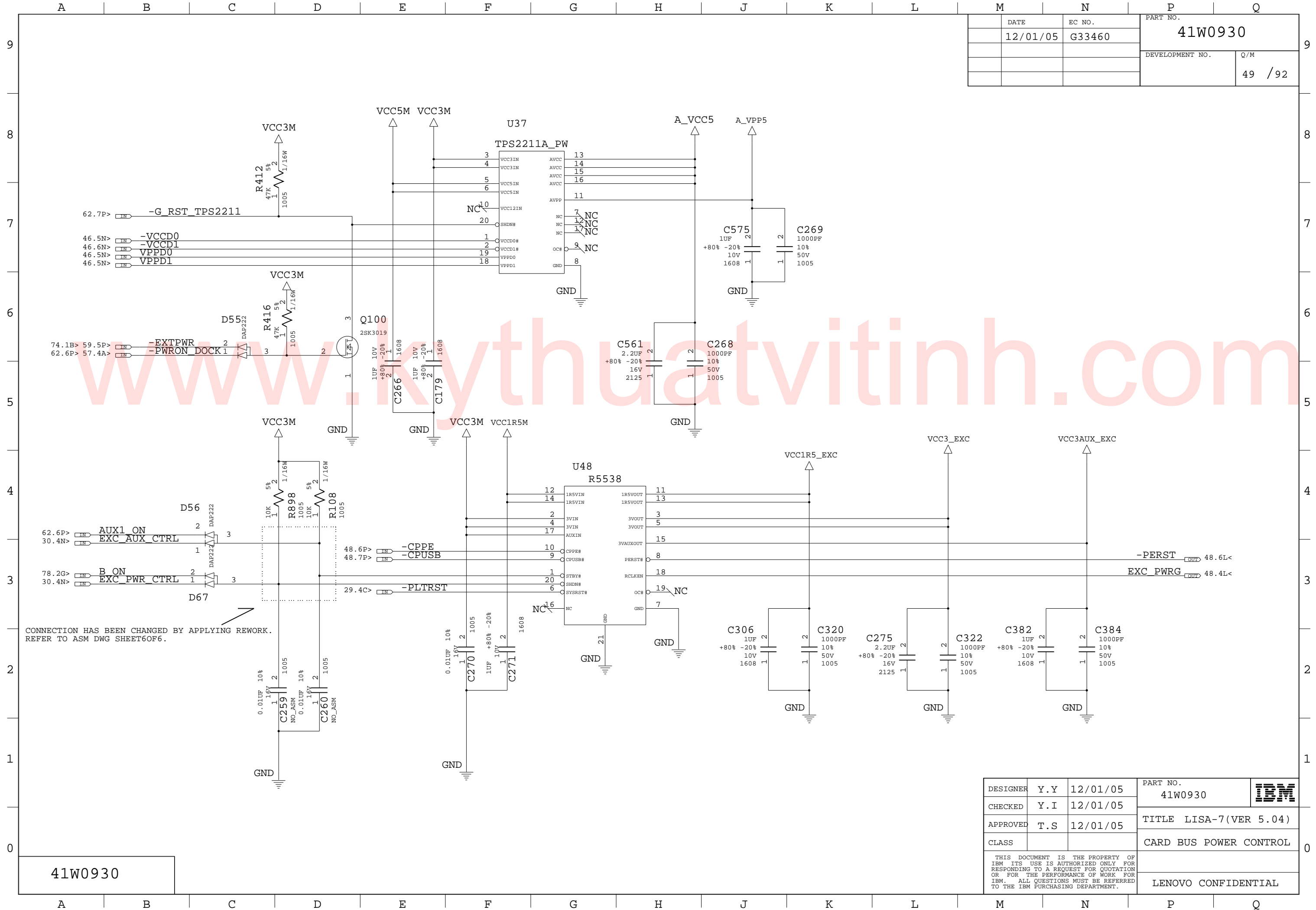

CONNECTION HAS BEEN CHANGED BY APPLYING REWORK.
REFER TO ASM DWG SHEET60F6.

41W0930

DESIGNER	Y.Y	12/01/05	PART NO.	41W0930	
CHECKED	Y.I	12/01/05	TITLE LISA-7(VER 5.04)		
APPROVED	T.S	12/01/05	CARD BUS POWER CONTROL		
CLASS			LENOVO CONFIDENTIAL		

THIS DOCUMENT IS THE PROPERTY OF IBM ITS USE IS AUTHORIZED ONLY FOR RESPONDING TO A REQUEST FOR QUOTATION OR FOR THE PERFORMANCE OF WORK FOR IBM. ALL QUESTIONS MUST BE REFERRED TO THE IBM PURCHASING DEPARTMENT.

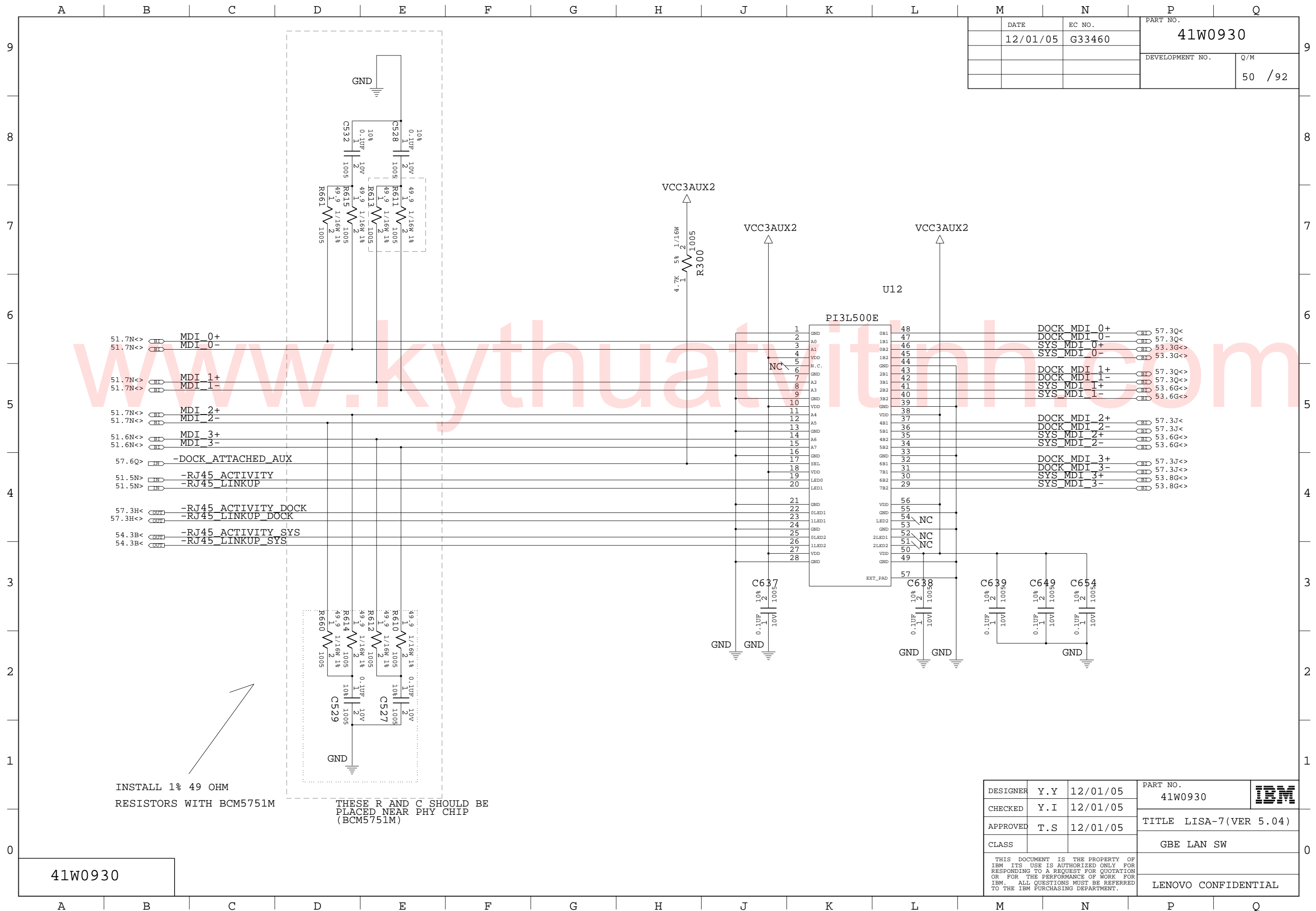

DATE	EC NO.	PART NO.	
12/01/05	G33460	41W0930	
		DEVELOPMENT NO.	Q/M
			50 / 92

INSTALL 1% 49 OHM
RESISTORS WITH BCM5751M

THESE R AND C SHOULD BE
PLACED NEAR PHY CHIP
(BCM5751M)

41W0930

DESIGNER	Y.Y	12/01/05	PART NO.	41W0930	
CHECKED	Y.I	12/01/05			
APPROVED	T.S	12/01/05	TITLE LISA-7(VER 5.04)		
CLASS			GBE LAN SW		
THIS DOCUMENT IS THE PROPERTY OF IBM ITS USE IS AUTHORIZED ONLY FOR RESPONDING TO A REQUEST FOR QUOTATION OR FOR THE PERFORMANCE OF WORK FOR IBM. ALL QUESTIONS MUST BE REFERRED TO THE IBM PURCHASING DEPARTMENT.					LENOVO CONFIDENTIAL

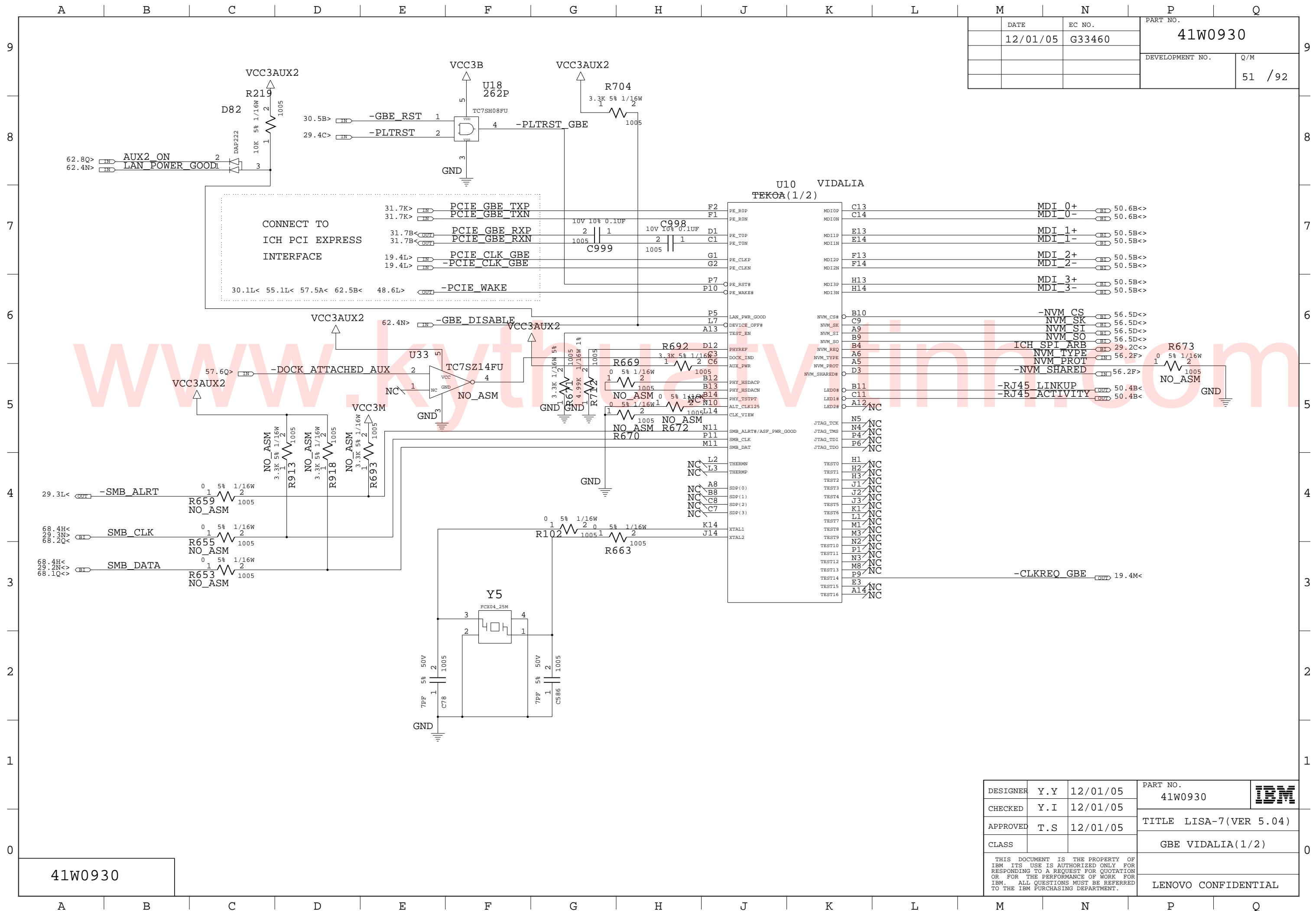

DATE	EC NO.	PART NO.	
12/01/05	G33460	41W0930	
		DEVELOPMENT NO.	Q/M
			51 / 92

41W0930

DESIGNER	Y.Y	12/01/05	PART NO.	41W0930	
CHECKED	Y.I	12/01/05			
APPROVED	T.S	12/01/05	TITLE LISA-7(VER 5.04)		
CLASS			GBE VIDALIA(1/2)		
THIS DOCUMENT IS THE PROPERTY OF IBM ITS USE IS AUTHORIZED ONLY FOR RESPONDING TO A REQUEST FOR QUOTATION OR FOR THE PERFORMANCE OF WORK FOR IBM. ALL QUESTIONS MUST BE REFERRED TO THE IBM PURCHASING DEPARTMENT.				LENOVO CONFIDENTIAL	

DATE	EC NO.	PART NO.
12/01/05	G33460	41W0930
DEVELOPMENT NO.		Q/M
		52 / 92

VCC3.3 SUPPLY NOTE:
 IF ALERTING OR WOL IS SUPPORTED, VCC3AUX MUST BE SOURCED FROM EITHER PCI_AUX 3.3V OR THE PLANAR 3.3V STBY. OTHERWISE VCC3.3 CAN BE SOURCED FROM A NON-STANDBY 3.3V POWER RAIL.

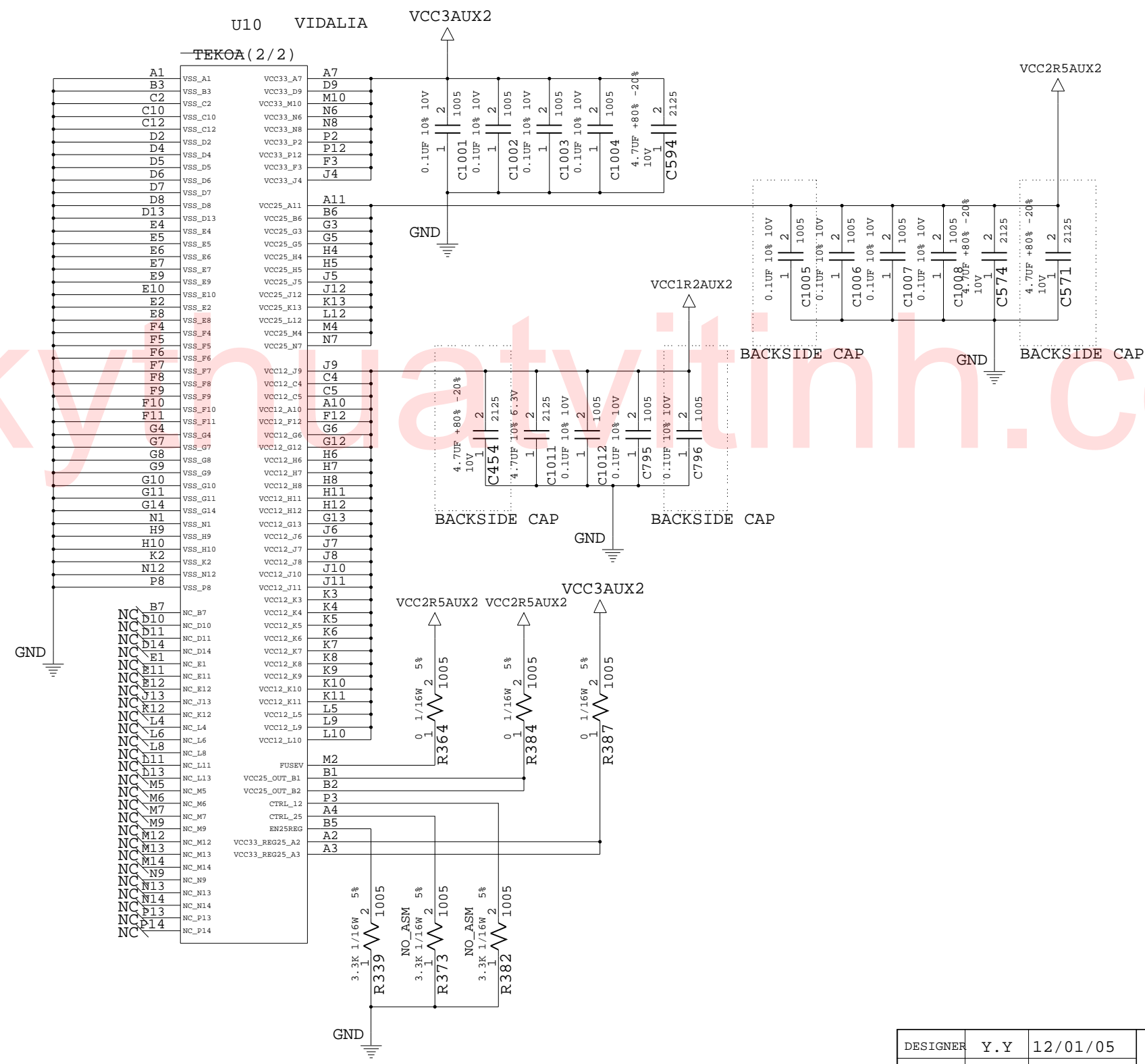

41W0930

DESIGNER	Y.Y	12/01/05	PART NO.	41W0930	IBM
CHECKED	Y.I	12/01/05	TITLE LISA-7(VER 5.04)		
APPROVED	T.S	12/01/05	GBE VIDALIA(2/2)		
CLASS			LENOVO CONFIDENTIAL		

THIS DOCUMENT IS THE PROPERTY OF IBM. ITS USE IS AUTHORIZED ONLY FOR RESPONDING TO A REQUEST FOR QUOTATION OR FOR THE PERFORMANCE OF WORK FOR IBM. ALL QUESTIONS MUST BE REFERRED TO THE IBM PURCHASING DEPARTMENT.

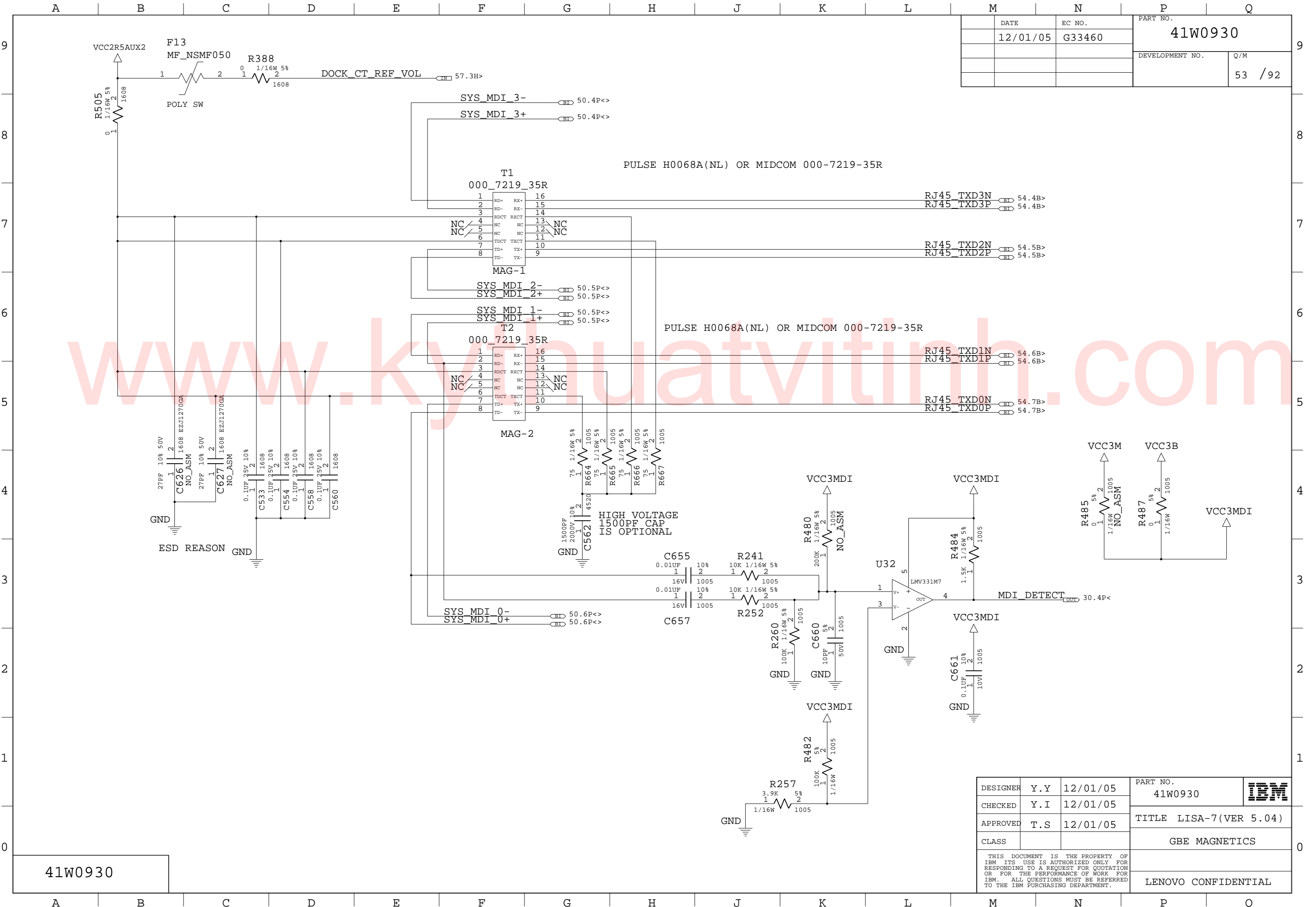

DATE	EC NO.	PART NO.
12/01/05	G33460	41W0930
DEVELOPMENT NO.		Q/M
		53 / 92

41W0930

DESIGNER	Y.Y	12/01/05	PART NO.	41W0930	
CHECKED	Y.I	12/01/05			
APPROVED	T.S	12/01/05	TITLE LISA-7(VER 5.04)		
CLASS			GBE MAGNETICS		
THIS DOCUMENT IS THE PROPERTY OF IBM. ITS USE IS AUTHORIZED ONLY FOR RESPONDING TO A REQUEST FOR QUOTATION OR FOR THE PERFORMANCE OF WORK FOR IBM. ALL QUESTIONS MUST BE REFERRED TO THE IBM PURCHASING DEPARTMENT.				LENOVO CONFIDENTIAL	

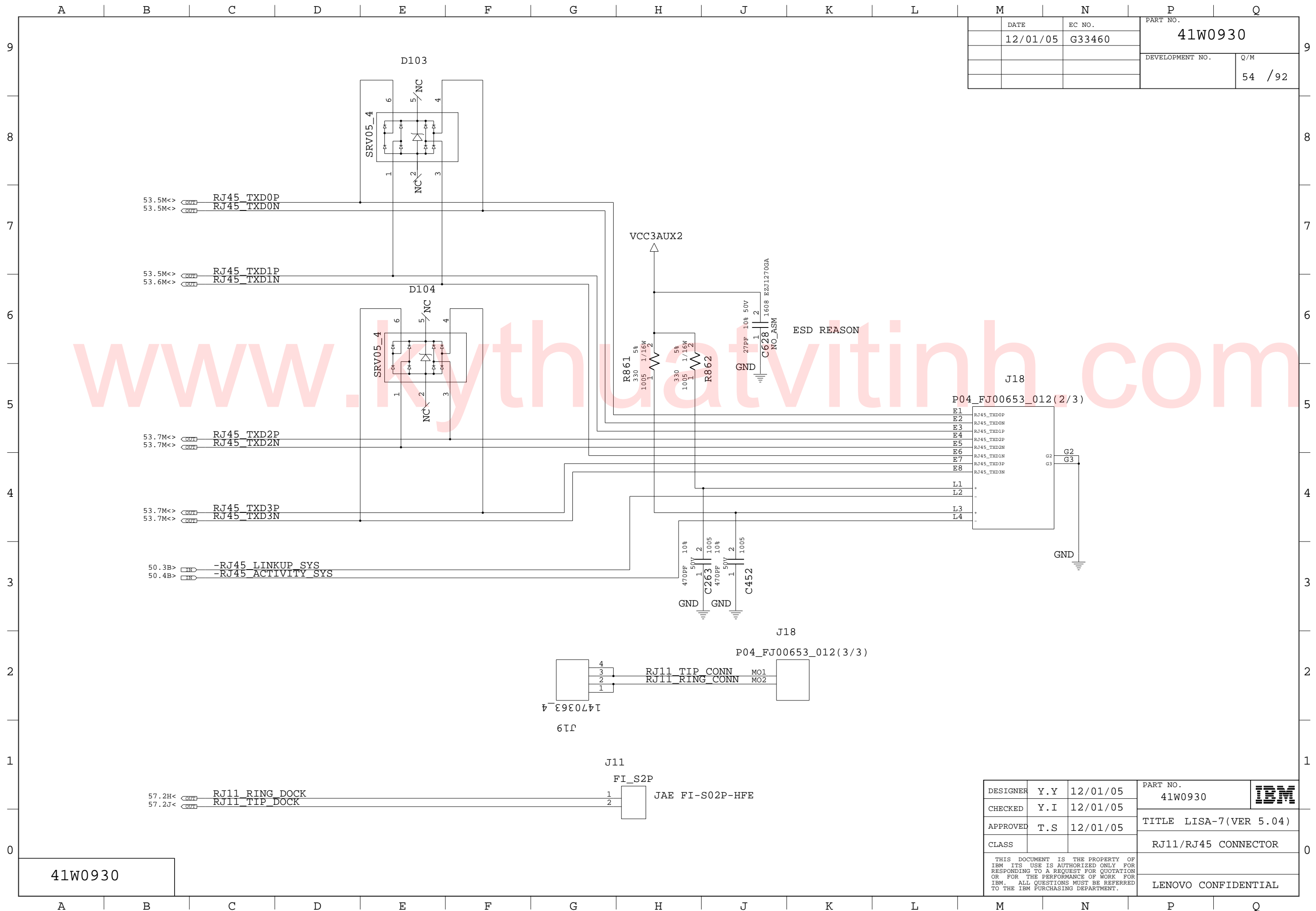

DATE	12/01/05	EC NO.	G33460	PART NO.	41W0930
DEVELOPMENT NO.				Q/M	54 / 92

41W0930

DESIGNER	Y.Y	12/01/05	PART NO.	41W0930	IBM
CHECKED	Y.I	12/01/05	TITLE LISA-7(VER 5.04)		
APPROVED	T.S	12/01/05	CLASS		RJ11/RJ45 CONNECTOR
THIS DOCUMENT IS THE PROPERTY OF IBM ITS USE IS AUTHORIZED ONLY FOR RESPONDING TO A REQUEST FOR QUOTATION OR FOR THE PERFORMANCE OF WORK FOR IBM. ALL QUESTIONS MUST BE REFERRED TO THE IBM PURCHASING DEPARTMENT.					LENOVO CONFIDENTIAL

MINI PCIE CONN-1 FOR WWAN

DATE	EC NO.	PART NO.
12/01/05	G33460	41W0930
DEVELOPMENT NO.		Q/M
		55 / 92

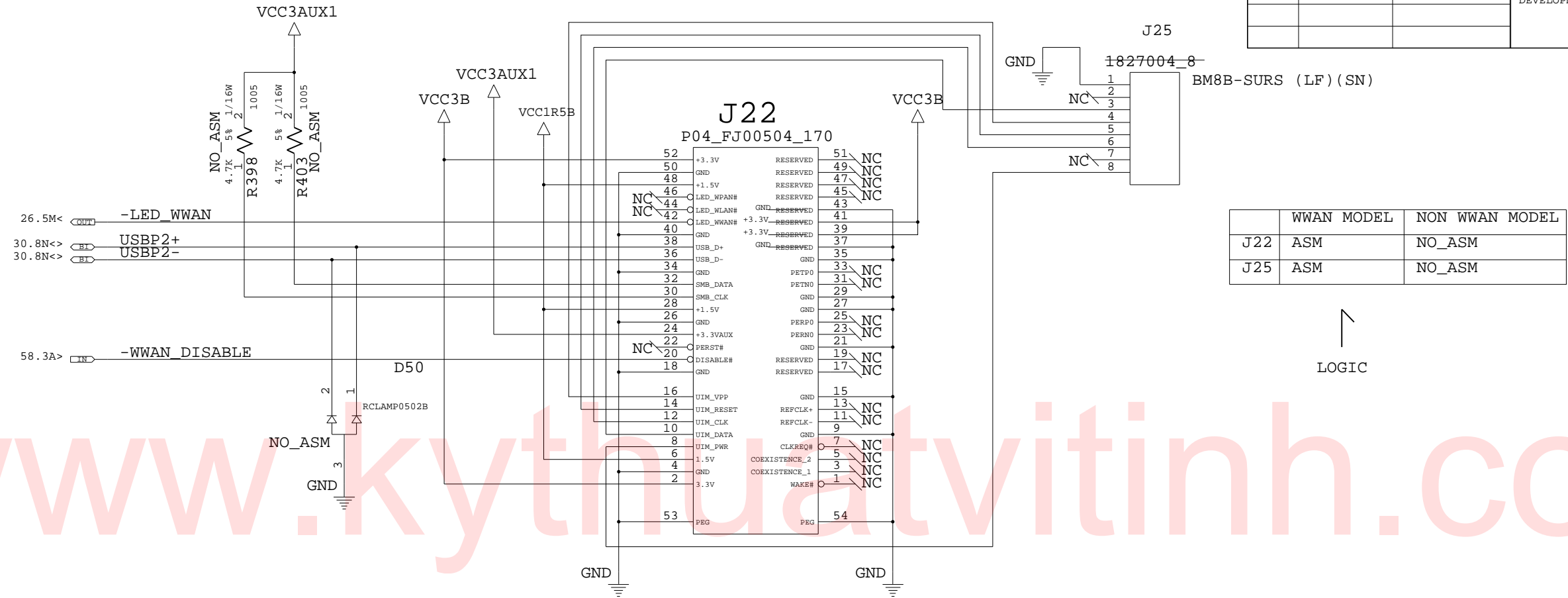

MINI PCIE CONN-2 FOR WLAN

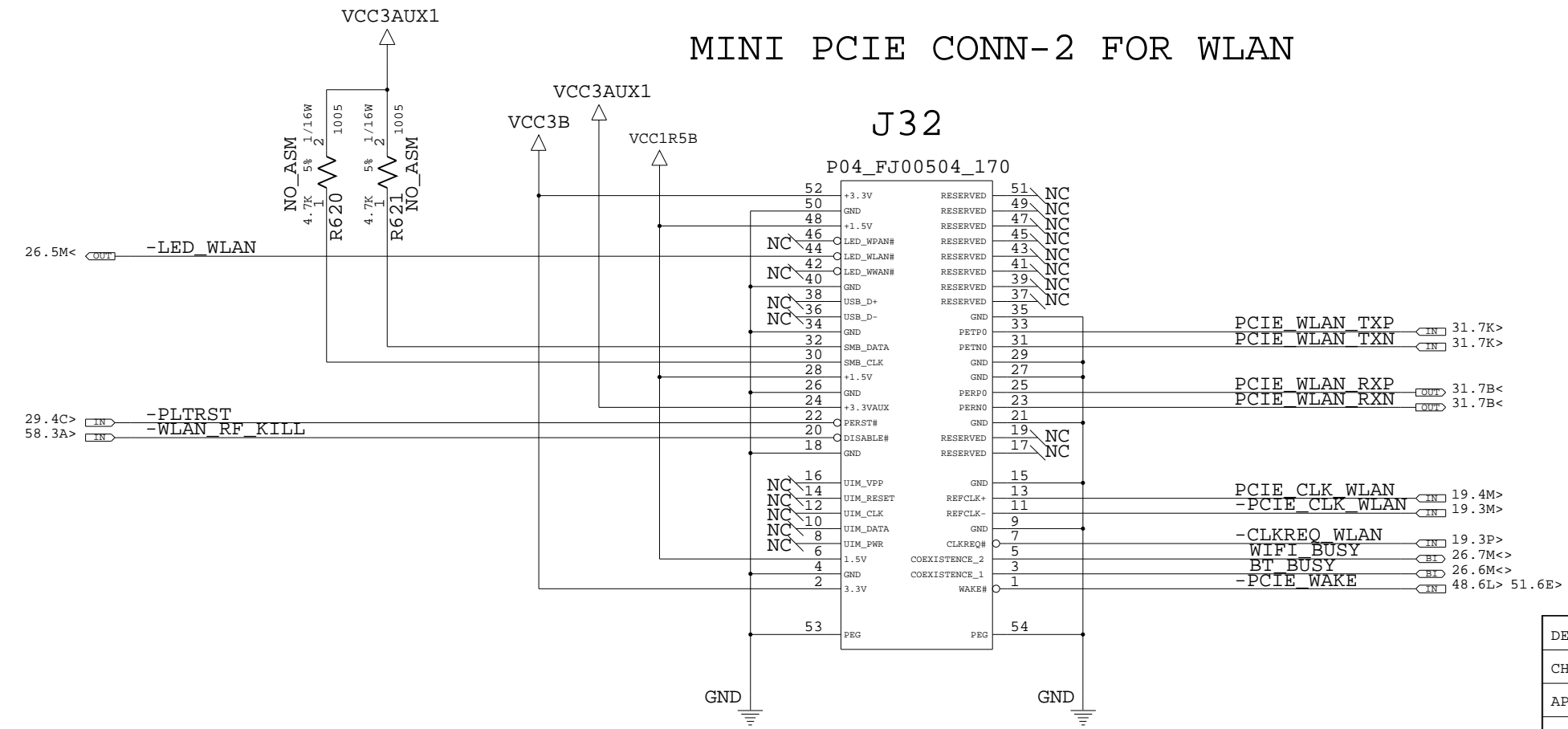

41W0930

DESIGNER	Y.Y	12/01/05	PART NO.	41W0930	
CHECKED	Y.I	12/01/05	TITLE LISA-7(VER 5.04)		
APPROVED	T.S	12/01/05	MINI-PCIE SLOT		THIS DOCUMENT IS THE PROPERTY OF IBM. ITS USE IS AUTHORIZED ONLY FOR RESPONDING TO A REQUEST FOR QUOTATION OR FOR THE PERFORMANCE OF WORK FOR IBM. ALL QUESTIONS MUST BE REFERRED TO THE IBM PURCHASING DEPARTMENT.
CLASS			LENOVO CONFIDENTIAL		

PLACE LESS THAN 2 INCH FROM THE ICH IF USING SHARED ARCHITECTURE.

DATE	EC NO.	PART NO.
12/01/05	G33460	41W0930
DEVELOPMENT NO.		Q/M
		56 / 92

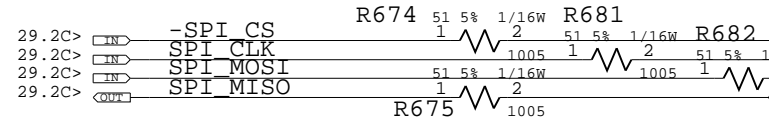

INSTALL ONLY WHEN SHARING FLASH WITH THE ICH. PLACE LESS THAN 0.5 INCH FROM THE ICH/SHARED FLASH.

INSTALL ONLY WHEN SHARING FLASH WITH THE ICH. PLACE TO MINIMIZE THE STUB SEEN ON THE DEDICATED LAN CONTROLLER NVM LINES WHEN REMOVED.



INSTALL ONLY WHEN SHARING FLASH WITH THE ICH. PLACE LESS THAN 0.5 INCH FROM THE LAN CONTROLLER.

DEDICATED LAN MEMORY POPULATION OPTIONS:
DEDICATED MEMORY ARCHITECTURE - EEPROM OR FLASH ACCEPTABLE
WHEN USING SHARED FLASH ARCHITECTURE - DO NOT INSTALL.
USE THE FLASH LOCATED NEAR THE ICH.

NVM STUFFING OPTIONS:

	R684	R696	R694	R683	REMARKS
SHARED FLASH CASE	ASM	ASM	NO ASM	NO ASM	
DEDICATED TEKOA (SPI FLASH)	NO ASM	ASM	NO ASM	ASM	
DEDICATED TEKOA (SPI EEPROM)	NO ASM	NO ASM	ASM *1	ASM *1	*1 TEKOA HAS ON-DIE PULL UPS
DEDICATED ICH	NO ASM	*2 ASM-FLASH NO ASM -EEPROM	*2 *1 ASM -EEPROM NO ASM -FLASH	ASM	*2 DEPENDS ON TEKOA'S NVM TYPE: PULL-UP=EEPROM PULL-DOWN=FLASH

41W0930

DESIGNER	Y.Y	12/01/05	PART NO.	41W0930	
CHECKED	Y.I	12/01/05	TITLE LISA-7(VER 5.04)		
APPROVED	T.S	12/01/05	EEPROM/FLASH/SHARED		
THIS DOCUMENT IS THE PROPERTY OF IBM ITS USE IS AUTHORIZED ONLY FOR RESPONDING TO A REQUEST FOR QUOTATION OR FOR THE PERFORMANCE OF WORK FOR IBM. ALL QUESTIONS MUST BE REFERRED TO THE IBM PURCHASING DEPARTMENT.					LENOVO CONFIDENTIAL

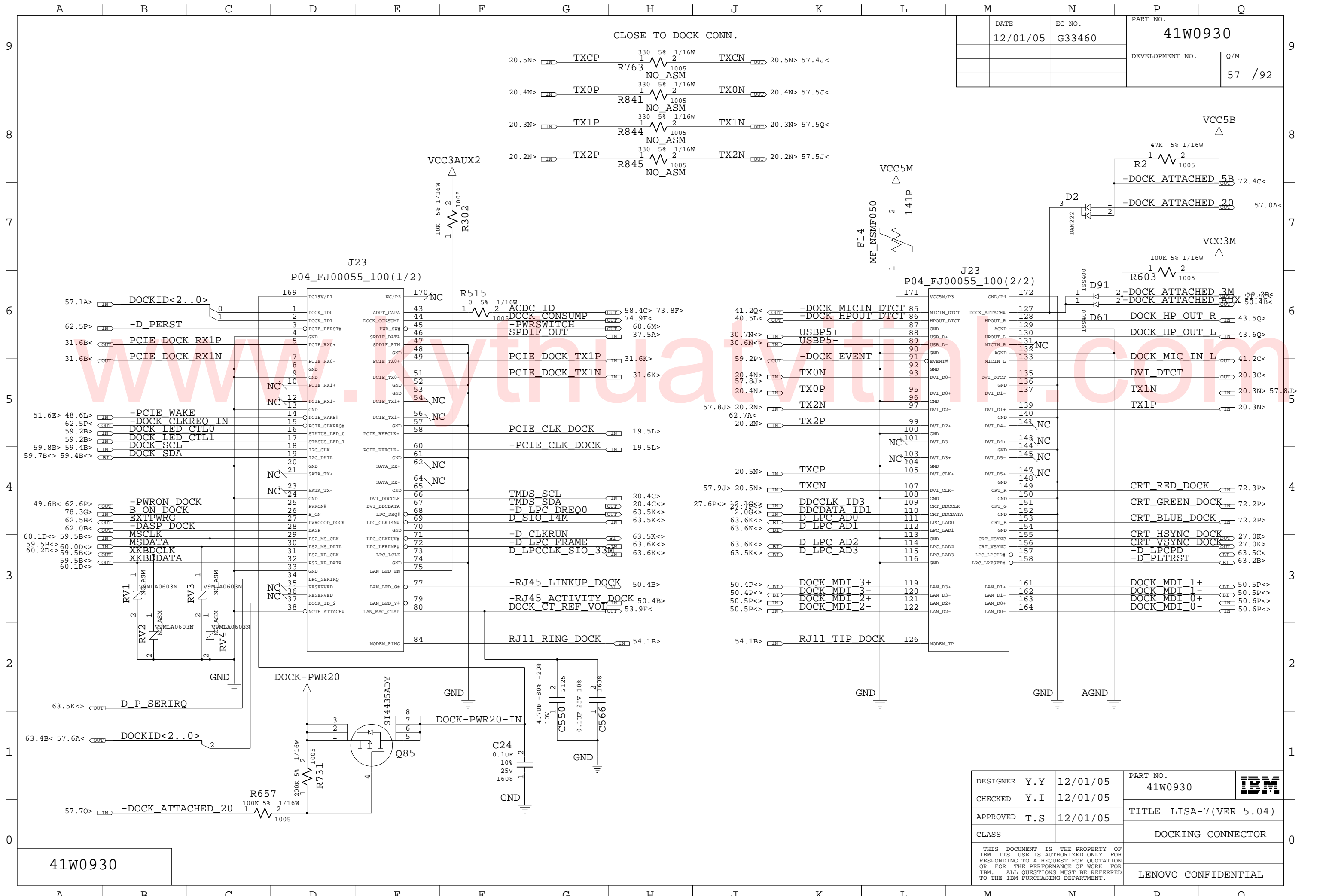

DATE	EC NO.	PART NO.	
12/01/05	G33460	41W0930	
		DEVELOPMENT NO.	Q/M
			57 / 92

DESIGNER	Y.Y	12/01/05	PART NO.	41W0930	
CHECKED	Y.I	12/01/05	TITLE		
APPROVED	T.S	12/01/05	DOCKING CONNECTOR		
CLASS			LENOVO CONFIDENTIAL		

THIS DOCUMENT IS THE PROPERTY OF IBM. ITS USE IS AUTHORIZED ONLY FOR RESPONDING TO A REQUEST FOR QUOTATION OR FOR THE PERFORMANCE OF WORK FOR IBM. ALL QUESTIONS MUST BE REFERRED TO THE IBM PURCHASING DEPARTMENT.

41W0930

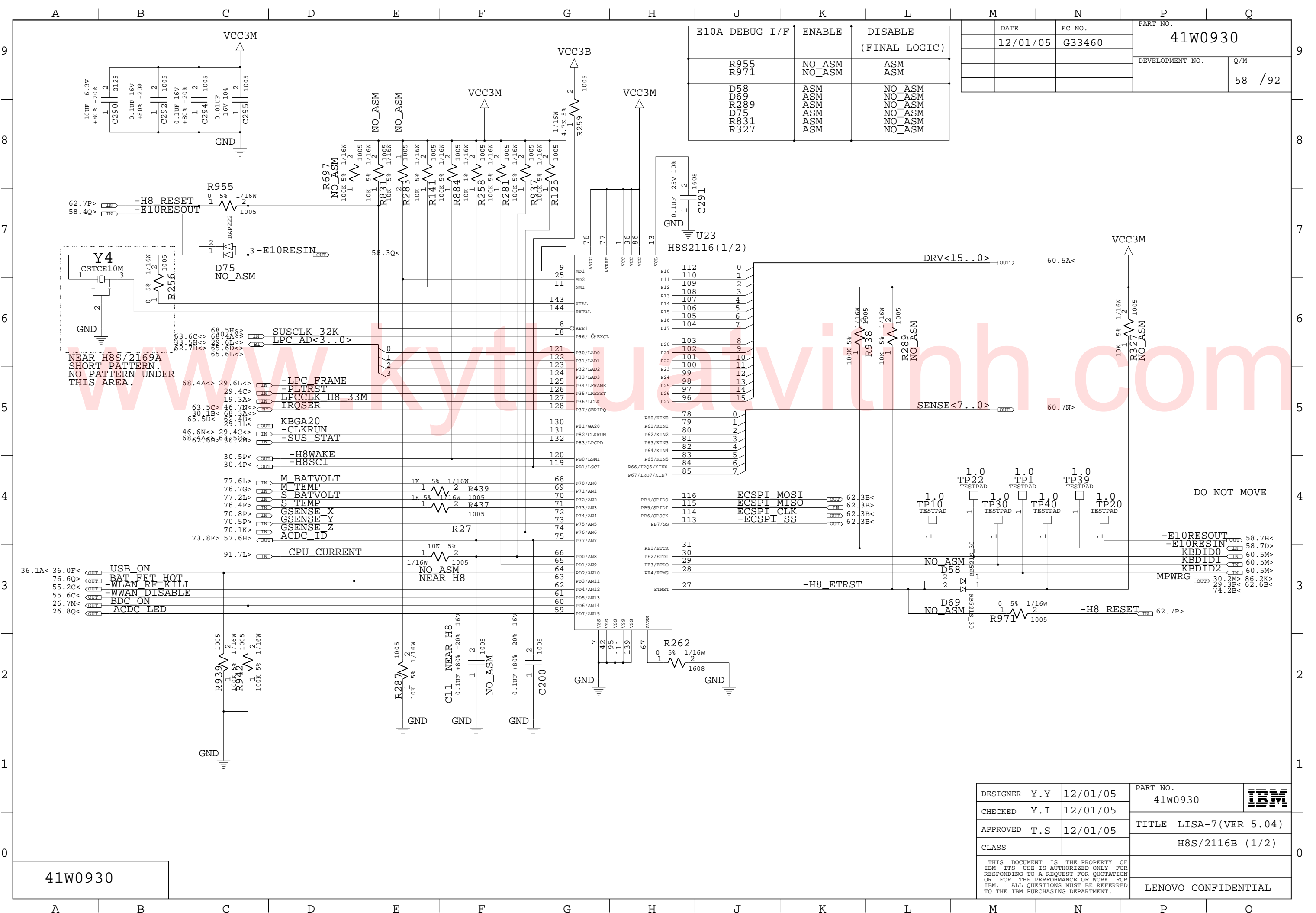

E10A DEBUG I/F	ENABLE	DISABLE (FINAL LOGIC)
R955	NO_ASM	ASM
R971	NO_ASM	ASM
D58	ASM	NO_ASM
D69	ASM	NO_ASM
R289	ASM	NO_ASM
D75	ASM	NO_ASM
R831	ASM	NO_ASM
R327	ASM	NO_ASM

DATE	EC NO.	PART NO.
12/01/05	G33460	41W0930
		DEVELOPMENT NO.
		Q/M
		58 / 92

NEAR H8S/2169A
SHORT PATTERN.
NO PATTERN UNDER
THIS AREA.

DO NOT MOVE

41W0930

DESIGNER	Y.Y	12/01/05	PART NO.	41W0930	IBM
CHECKED	Y.I	12/01/05	TITLE	LISA-7(VER 5.04)	
APPROVED	T.S	12/01/05		H8S/2116B (1/2)	
CLASS					
THIS DOCUMENT IS THE PROPERTY OF IBM ITS USE IS AUTHORIZED ONLY FOR RESPONDING TO A REQUEST FOR QUOTATION OR FOR THE PERFORMANCE OF WORK FOR IBM. ALL QUESTIONS MUST BE REFERRED TO THE IBM PURCHASING DEPARTMENT.					LENVO CONFIDENTIAL

DATE	EC NO.	PART NO.
12/01/05	G33460	41W0930
DEVELOPMENT NO.		Q/M
		59 /92

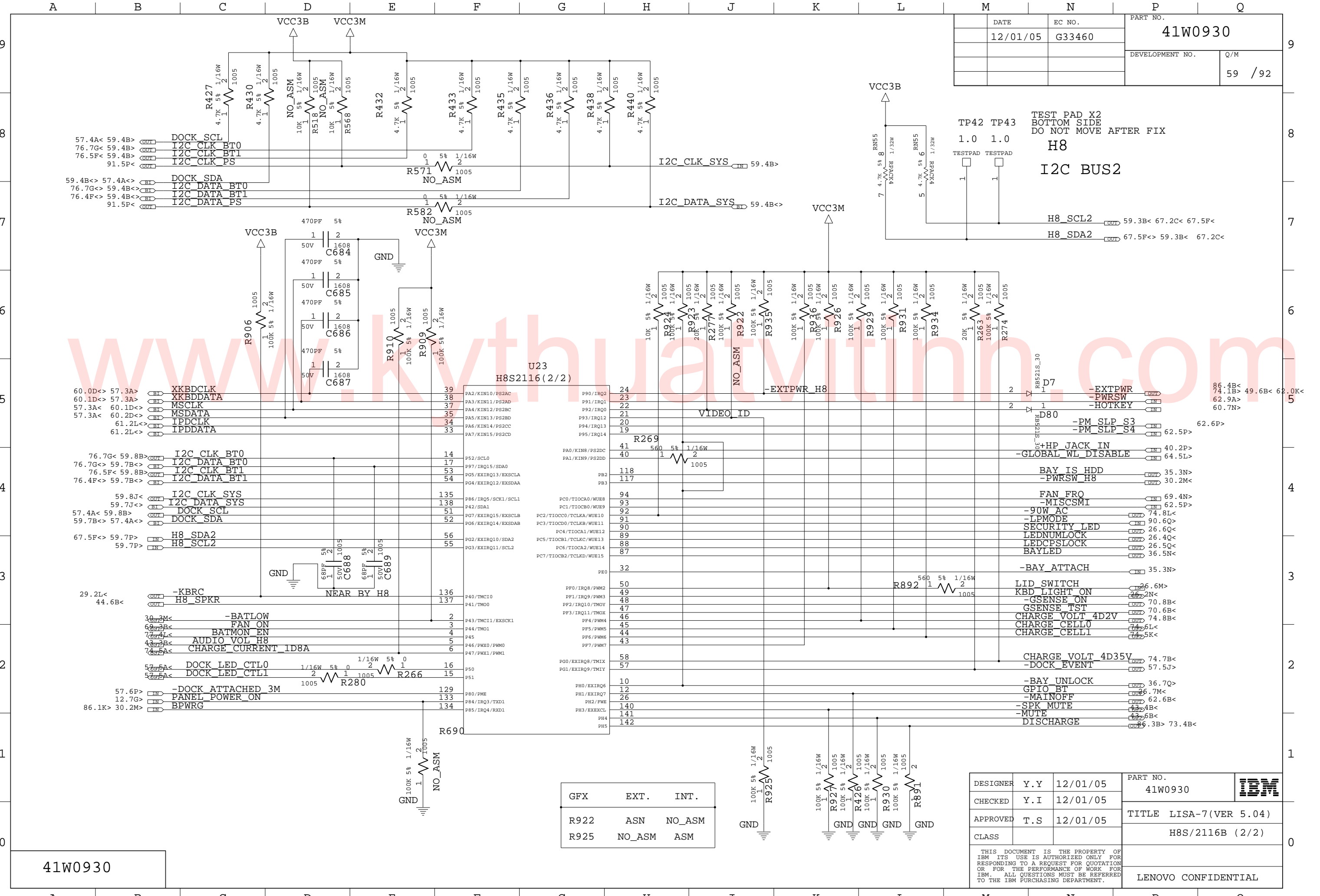
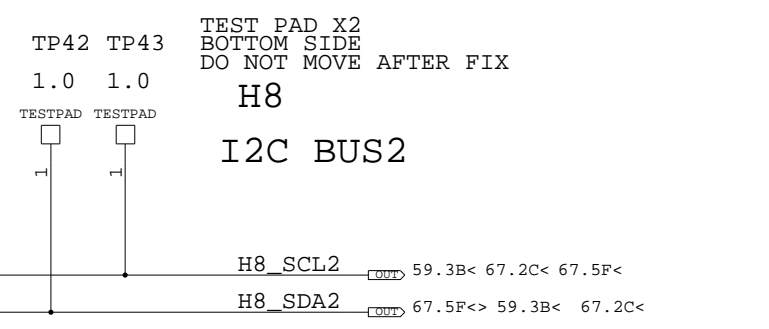

GFX	EXT.	INT.
R922	ASN	NO_ASM
R925	NO_ASM	ASM

DESIGNER	Y.Y	12/01/05	PART NO.	41W0930	
CHECKED	Y.I	12/01/05	TITLE LISA-7(VER 5.04)		
APPROVED	T.S	12/01/05	H8S/2116B (2/2)		
CLASS					
THIS DOCUMENT IS THE PROPERTY OF IBM ITS USE IS AUTHORIZED ONLY FOR RESPONDING TO A REQUEST FOR QUOTATION OR FOR THE PERFORMANCE OF WORK FOR IBM. ALL QUESTIONS MUST BE REFERRED TO THE IBM PURCHASING DEPARTMENT.					LENOVO CONFIDENTIAL

41W0930

www.kyath.in.com

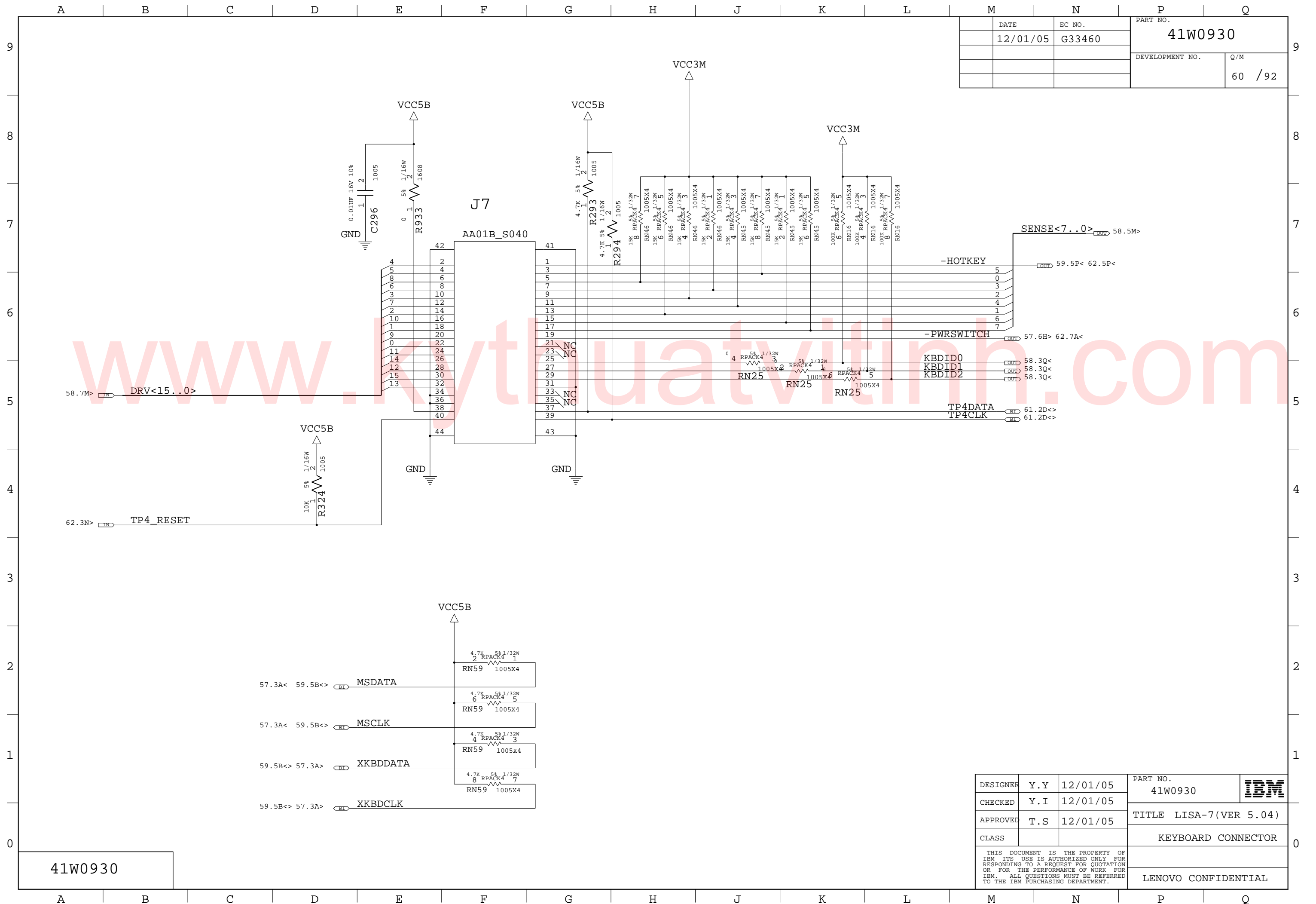

DATE	EC NO.	PART NO.	
12/01/05	G33460	41W0930	
		DEVELOPMENT NO.	Q/M
			60 / 92

41W0930

DESIGNER	Y.Y	12/01/05	PART NO.	41W0930	
CHECKED	Y.I	12/01/05			
APPROVED	T.S	12/01/05	TITLE LISA-7(VER 5.04)		
CLASS			KEYBOARD CONNECTOR		
THIS DOCUMENT IS THE PROPERTY OF IBM. ITS USE IS AUTHORIZED ONLY FOR RESPONDING TO A REQUEST FOR QUOTATION OR FOR THE PERFORMANCE OF WORK FOR IBM. ALL QUESTIONS MUST BE REFERRED TO THE IBM PURCHASING DEPARTMENT.				LENOVO CONFIDENTIAL	

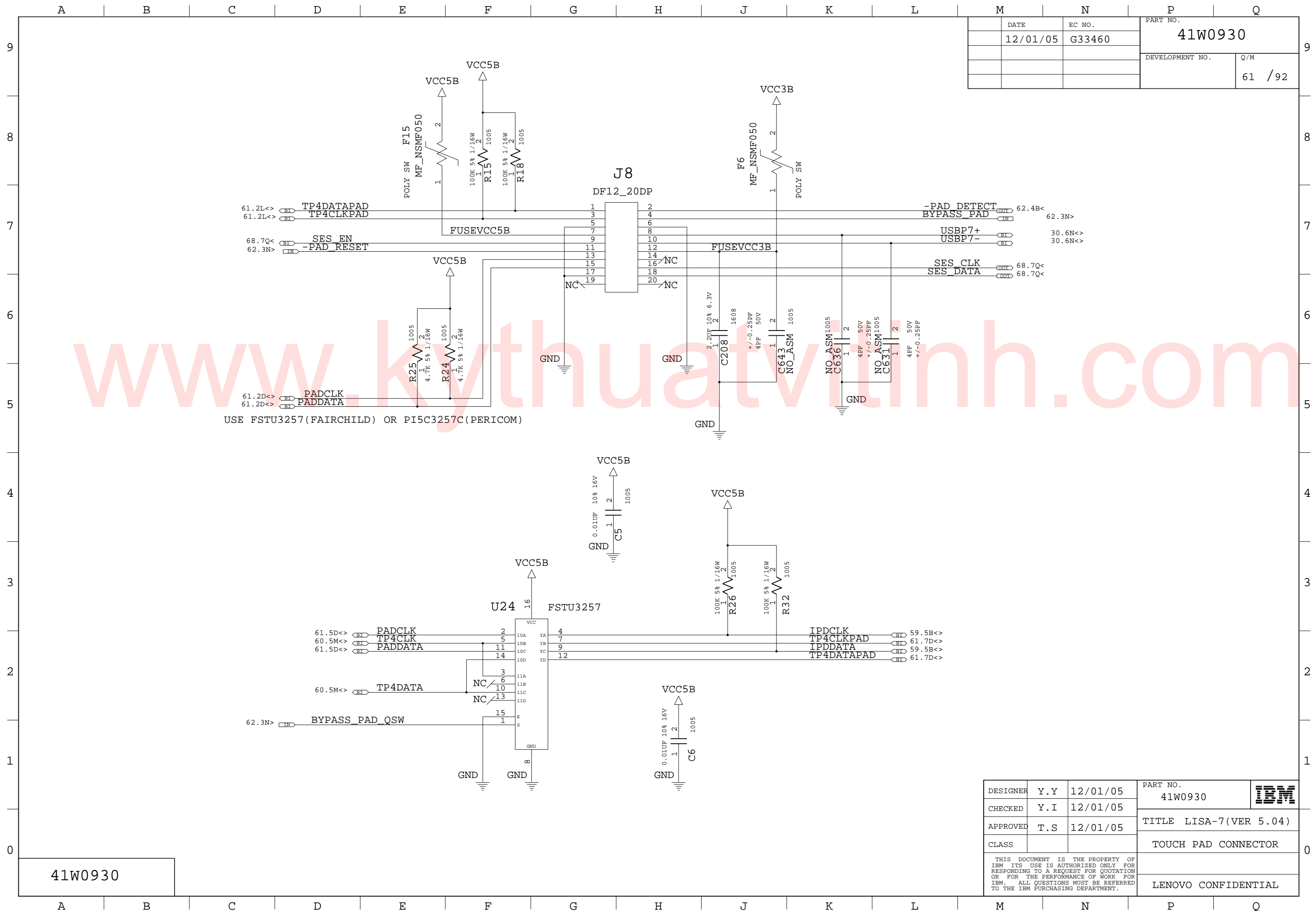

DATE	EC NO.	PART NO.	
12/01/05	G33460	41W0930	
		DEVELOPMENT NO.	Q/M
			61 / 92

41W0930

DESIGNER	Y.Y	12/01/05	PART NO.	41W0930	
CHECKED	Y.I	12/01/05			
APPROVED	T.S	12/01/05	TITLE LISA-7(VER 5.04)		
CLASS			TOUCH PAD CONNECTOR		
THIS DOCUMENT IS THE PROPERTY OF IBM ITS USE IS AUTHORIZED ONLY FOR RESPONDING TO A REQUEST FOR QUOTATION OR FOR THE PERFORMANCE OF WORK FOR IBM. ALL QUESTIONS MUST BE REFERRED TO THE IBM PURCHASING DEPARTMENT.				LENOVO CONFIDENTIAL	

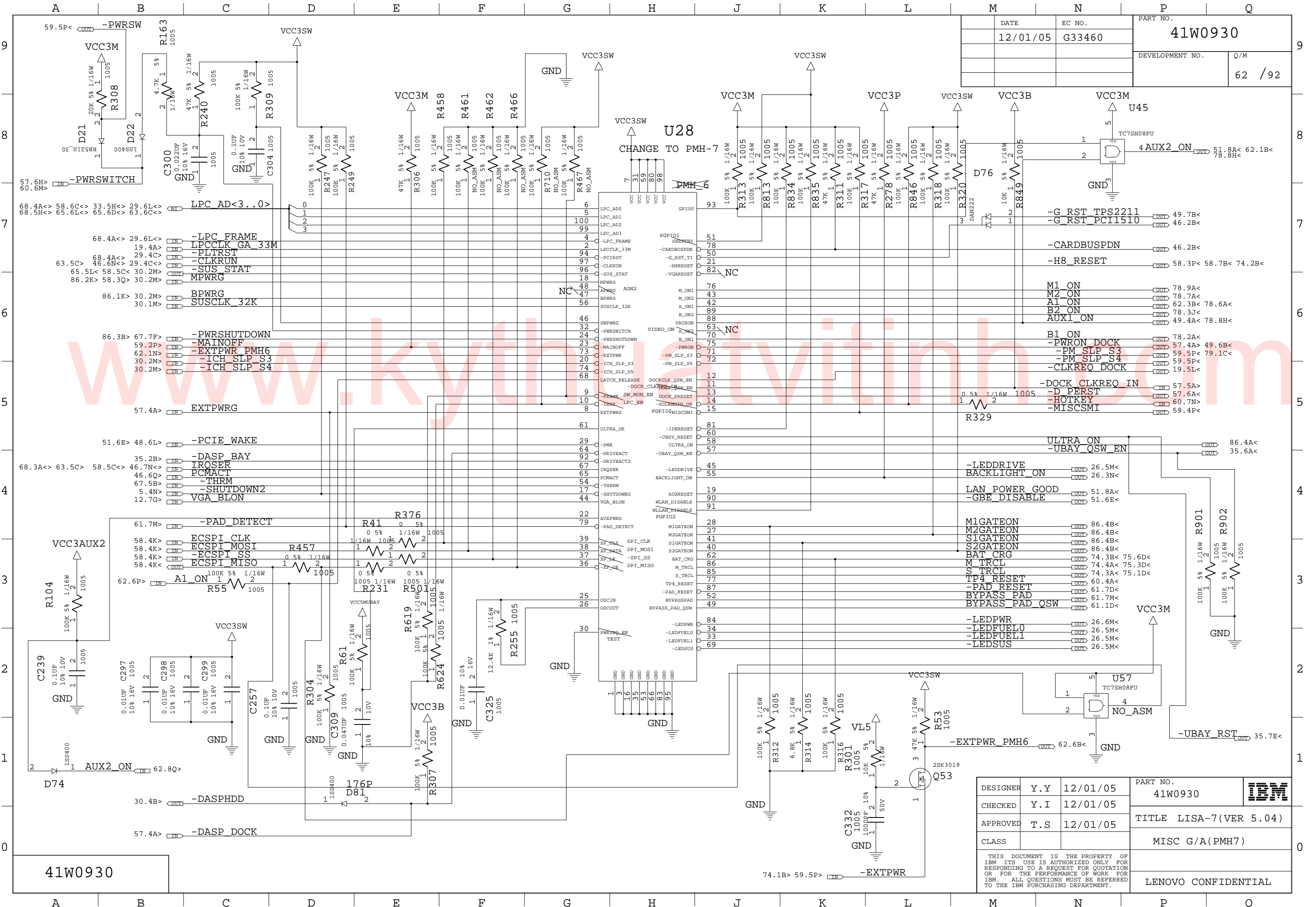

DATE	EC NO.	PART NO.
12/01/05	G33460	41W0930
DEVELOPMENT NO.		Q/M
		62 / 92

DESIGNER	Y.Y	12/01/05	PART NO.	41W0930	
CHECKED	Y.I	12/01/05	TITLE LISA-7(VER 5.04)		
APPROVED	T.S	12/01/05	MISC G/A(PM7)		
CLASS			LENOVO CONFIDENTIAL		

41W0930

THIS DOCUMENT IS THE PROPERTY OF IBM ITS USE IS AUTHORIZED ONLY FOR RESPONDING TO A REQUEST FOR QUOTATION OR FOR THE PERFORMANCE OF WORK FOR IBM. ALL QUESTIONS MUST BE REFERRED TO THE IBM PURCHASING DEPARTMENT.

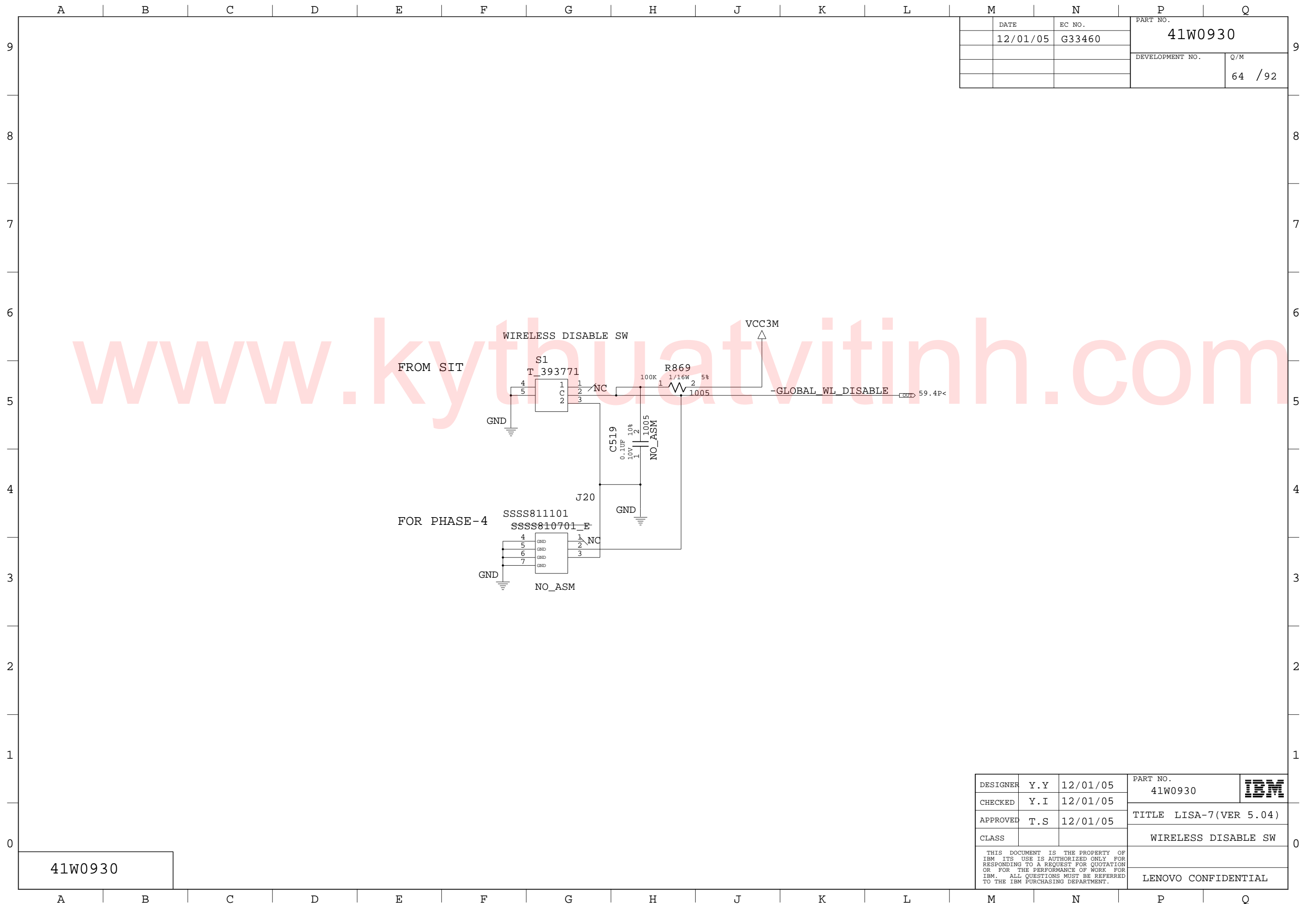

DATE	EC NO.	PART NO.	
12/01/05	G33460	41W0930	
		DEVELOPMENT NO.	Q/M
			64 /92

41W0930

DESIGNER	Y.Y	12/01/05	PART NO.	41W0930	IBM
CHECKED	Y.I	12/01/05			
APPROVED	T.S	12/01/05	TITLE LISA-7(VER 5.04)		
CLASS			WIRELESS DISABLE SW		
THIS DOCUMENT IS THE PROPERTY OF IBM ITS USE IS AUTHORIZED ONLY FOR RESPONDING TO A REQUEST FOR QUOTATION OR FOR THE PERFORMANCE OF WORK FOR IBM. ALL QUESTIONS MUST BE REFERRED TO THE IBM PURCHASING DEPARTMENT.				LENOVO CONFIDENTIAL	

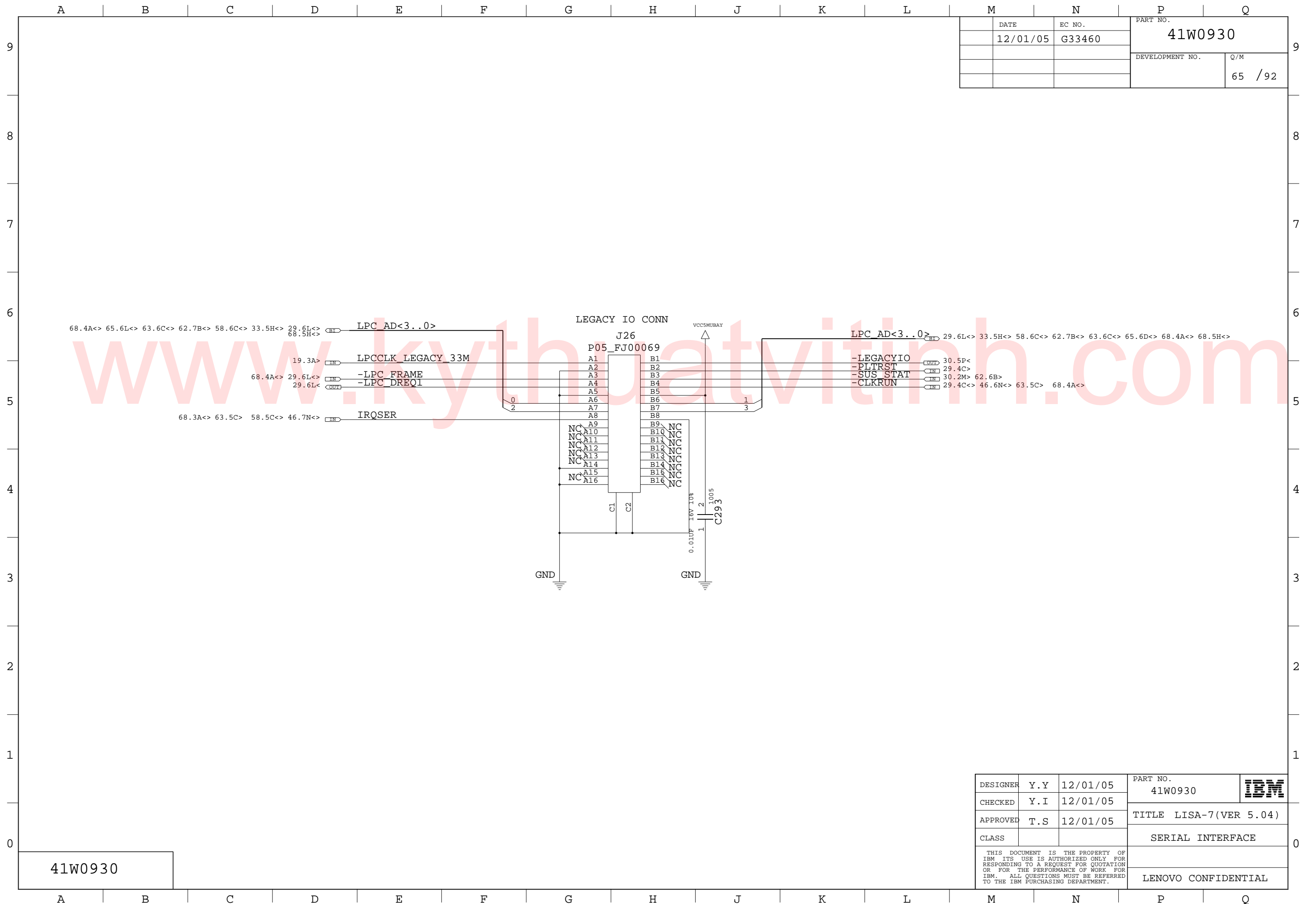

DATE	EC NO.	PART NO.	
12/01/05	G33460	41W0930	
		DEVELOPMENT NO.	Q/M
			65 /92

41W0930

DESIGNER	Y.Y	12/01/05	PART NO.	41W0930	IBM
CHECKED	Y.I	12/01/05			
APPROVED	T.S	12/01/05	TITLE LISA-7(VER 5.04)		
CLASS			SERIAL INTERFACE		
THIS DOCUMENT IS THE PROPERTY OF IBM ITS USE IS AUTHORIZED ONLY FOR RESPONDING TO A REQUEST FOR QUOTATION OR FOR THE PERFORMANCE OF WORK FOR IBM. ALL QUESTIONS MUST BE REFERRED TO THE IBM PURCHASING DEPARTMENT.					LENOVO CONFIDENTIAL

DATE	EC NO.	PART NO.	
12/01/05	G33460	41W0930	
		DEVELOPMENT NO.	Q/M
		67	/92

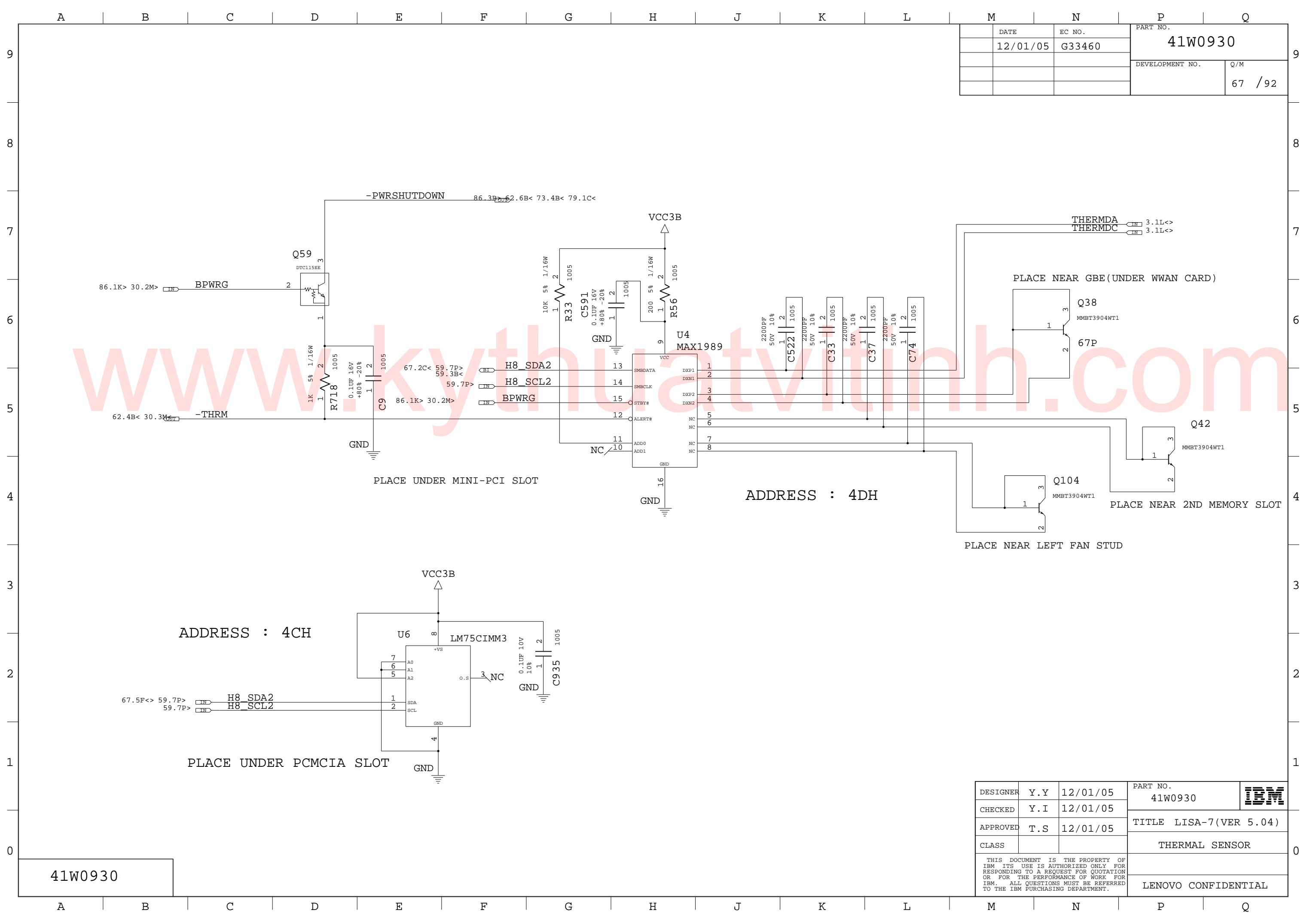

41W0930

DESIGNER	Y.Y	12/01/05	PART NO.	41W0930	IBM
CHECKED	Y.I	12/01/05			
APPROVED	T.S	12/01/05	TITLE LISA-7(VER 5.04)		
CLASS			THERMAL SENSOR		
THIS DOCUMENT IS THE PROPERTY OF IBM ITS USE IS AUTHORIZED ONLY FOR RESPONDING TO A REQUEST FOR QUOTATION OR FOR THE PERFORMANCE OF WORK FOR IBM. ALL QUESTIONS MUST BE REFERRED TO THE IBM PURCHASING DEPARTMENT.				LENOVO CONFIDENTIAL	

DATE	EC NO.	PART NO.	
12/01/05	G33460	41W0930	
		DEVELOPMENT NO.	Q/M
		68	/92

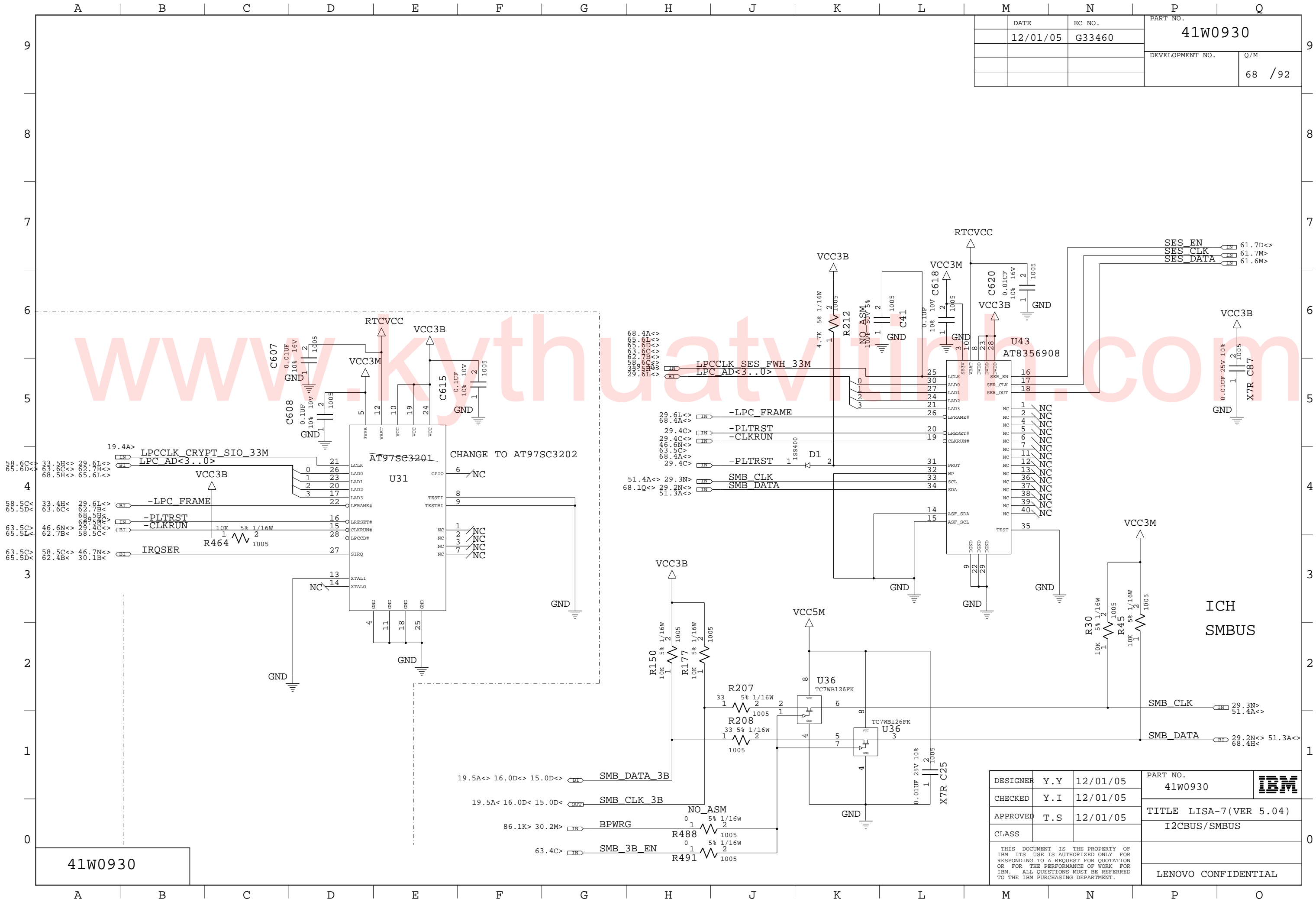

41W0930

DESIGNER	Y.Y	12/01/05	PART NO.	41W0930	
CHECKED	Y.I	12/01/05	TITLE LISA-7(VER 5.04)		
APPROVED	T.S	12/01/05	I2CBUS/SMBUS		
CLASS					
THIS DOCUMENT IS THE PROPERTY OF IBM ITS USE IS AUTHORIZED ONLY FOR RESPONDING TO A REQUEST FOR QUOTATION OR FOR THE PERFORMANCE OF WORK FOR IBM. ALL QUESTIONS MUST BE REFERRED TO THE IBM PURCHASING DEPARTMENT.					LENOVO CONFIDENTIAL

	DATE	EC NO.	PART NO.	
	12/01/05	G33460	41W0930	
			DEVELOPMENT NO.	Q/M
				69 / 92

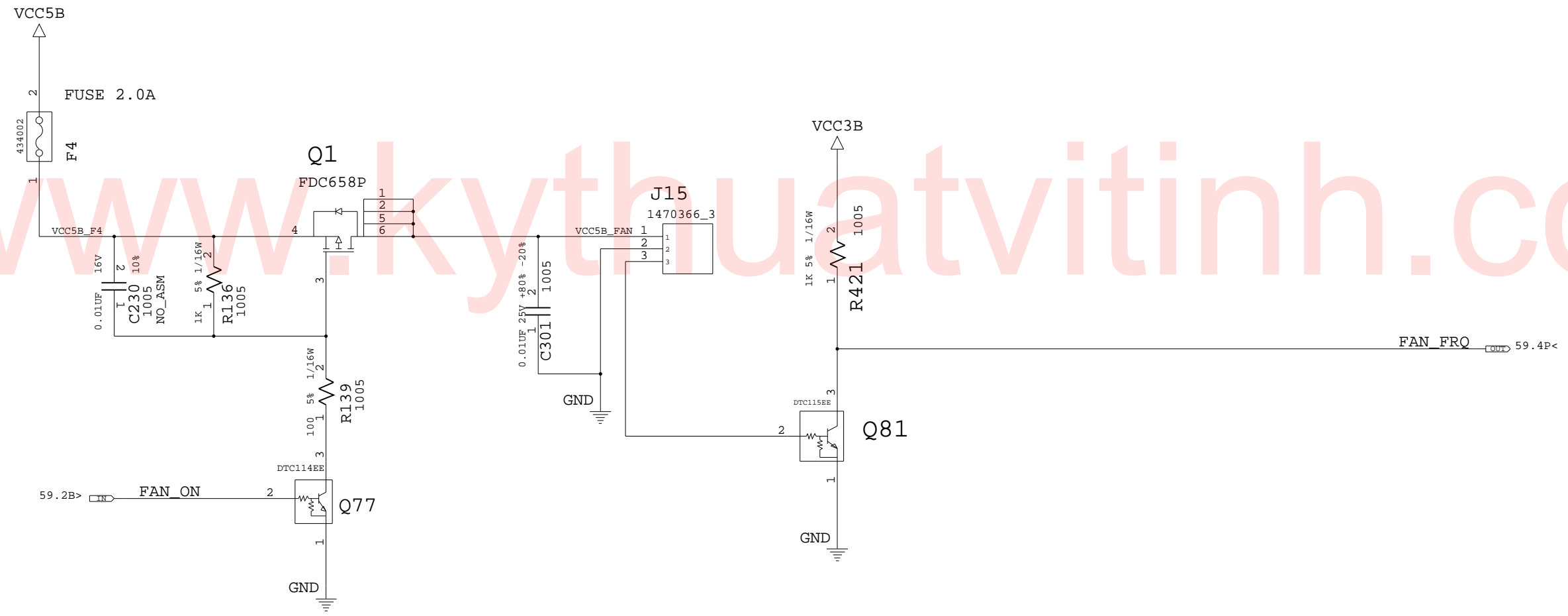

41W0930

DESIGNER	Y.Y	12/01/05	PART NO.	41W0930	IBM
CHECKED	Y.I	12/01/05			
APPROVED	T.S	12/01/05	TITLE LISA-7(VER 5.04)		
CLASS			FAN CONNECTOR		
THIS DOCUMENT IS THE PROPERTY OF IBM ITS USE IS AUTHORIZED ONLY FOR RESPONDING TO A REQUEST FOR QUOTATION OR FOR THE PERFORMANCE OF WORK FOR IBM. ALL QUESTIONS MUST BE REFERRED TO THE IBM PURCHASING DEPARTMENT.				LENOVO CONFIDENTIAL	

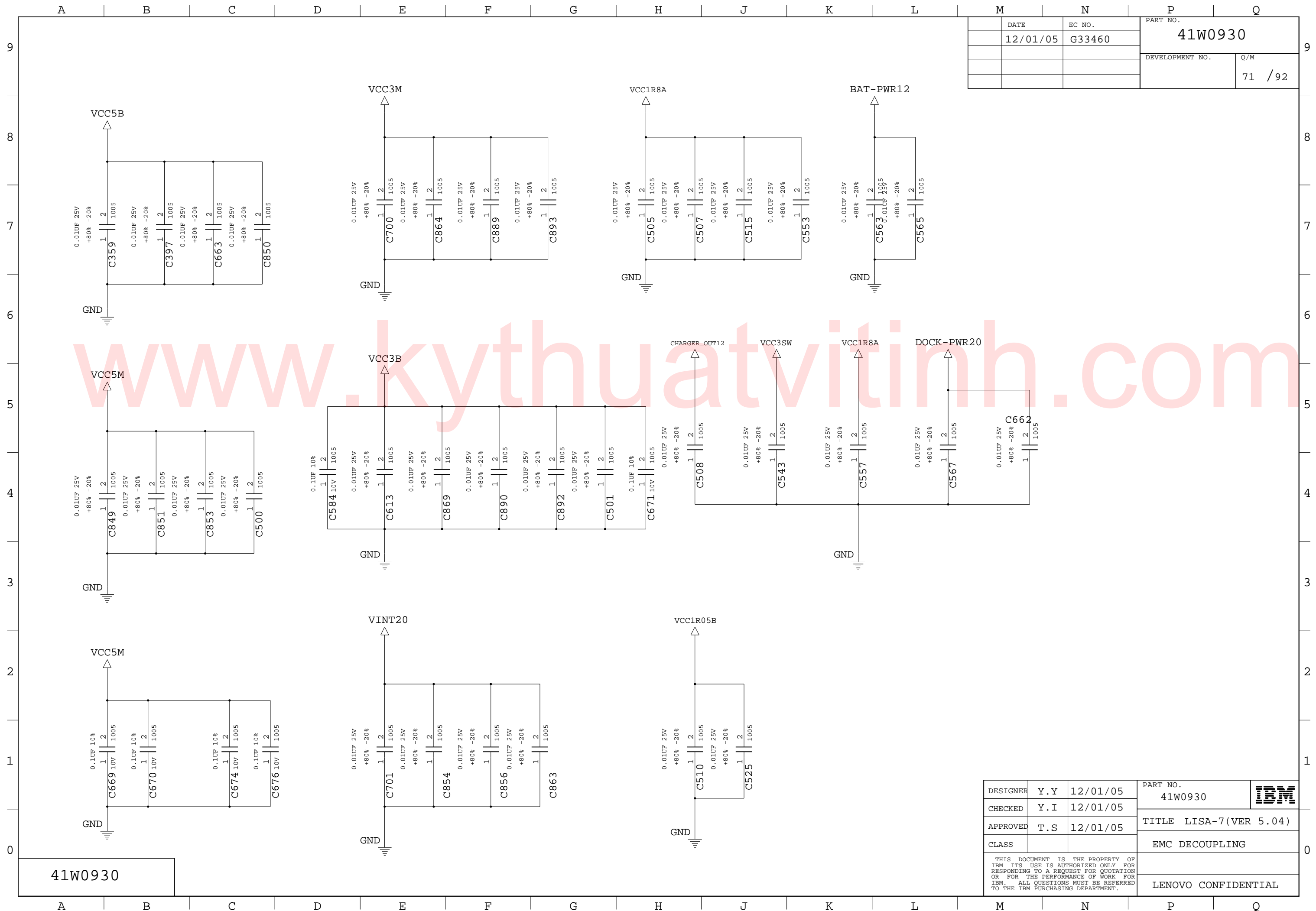

DATE	EC NO.	PART NO.	
12/01/05	G33460	41W0930	
		DEVELOPMENT NO.	Q/M
			71 / 92

41W0930

DESIGNER	Y.Y	12/01/05	PART NO.	41W0930	
CHECKED	Y.I	12/01/05	TITLE		
APPROVED	T.S	12/01/05	EMC DECOUPLING		
CLASS			LENOVO CONFIDENTIAL		
THIS DOCUMENT IS THE PROPERTY OF IBM. ITS USE IS AUTHORIZED ONLY FOR RESPONDING TO A REQUEST FOR QUOTATION OR FOR THE PERFORMANCE OF WORK FOR IBM. ALL QUESTIONS MUST BE REFERRED TO THE IBM PURCHASING DEPARTMENT.					

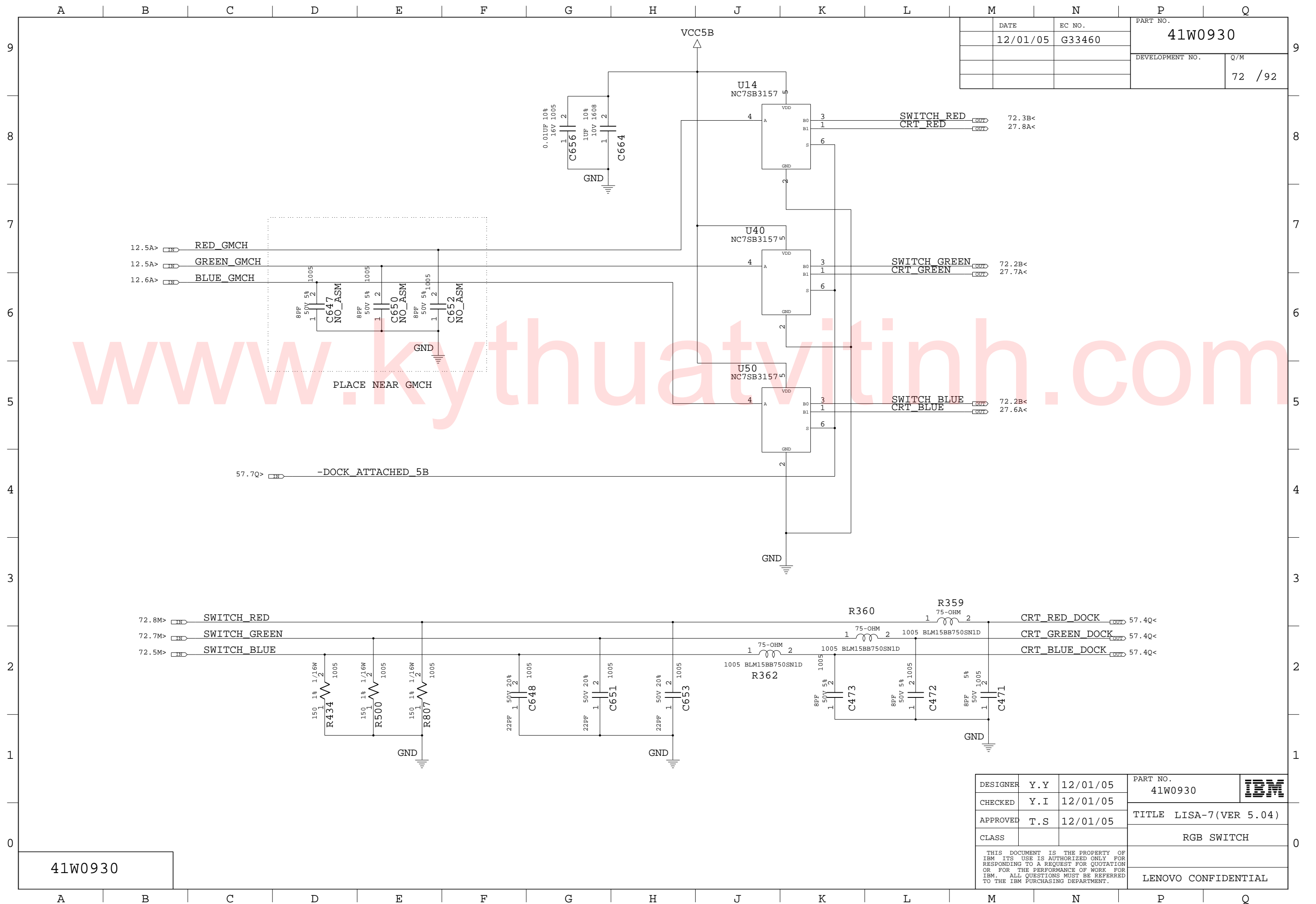

DATE	12/01/05	EC NO.	G33460	PART NO.	41W0930
				DEVELOPMENT NO.	Q/M
					72 / 92

41W0930

DESIGNER	Y.Y	12/01/05	PART NO.	41W0930	
CHECKED	Y.I	12/01/05	TITLE LISA-7(VER 5.04)		
APPROVED	T.S	12/01/05	CLASS		RGB SWITCH
THIS DOCUMENT IS THE PROPERTY OF IBM ITS USE IS AUTHORIZED ONLY FOR RESPONDING TO A REQUEST FOR QUOTATION OR FOR THE PERFORMANCE OF WORK FOR IBM. ALL QUESTIONS MUST BE REFERRED TO THE IBM PURCHASING DEPARTMENT.					LENOVO CONFIDENTIAL

DATE	12/01/05	EC NO.	G33460	PART NO.	41W0930
DEVELOPMENT NO.		Q/M	73 / 92		

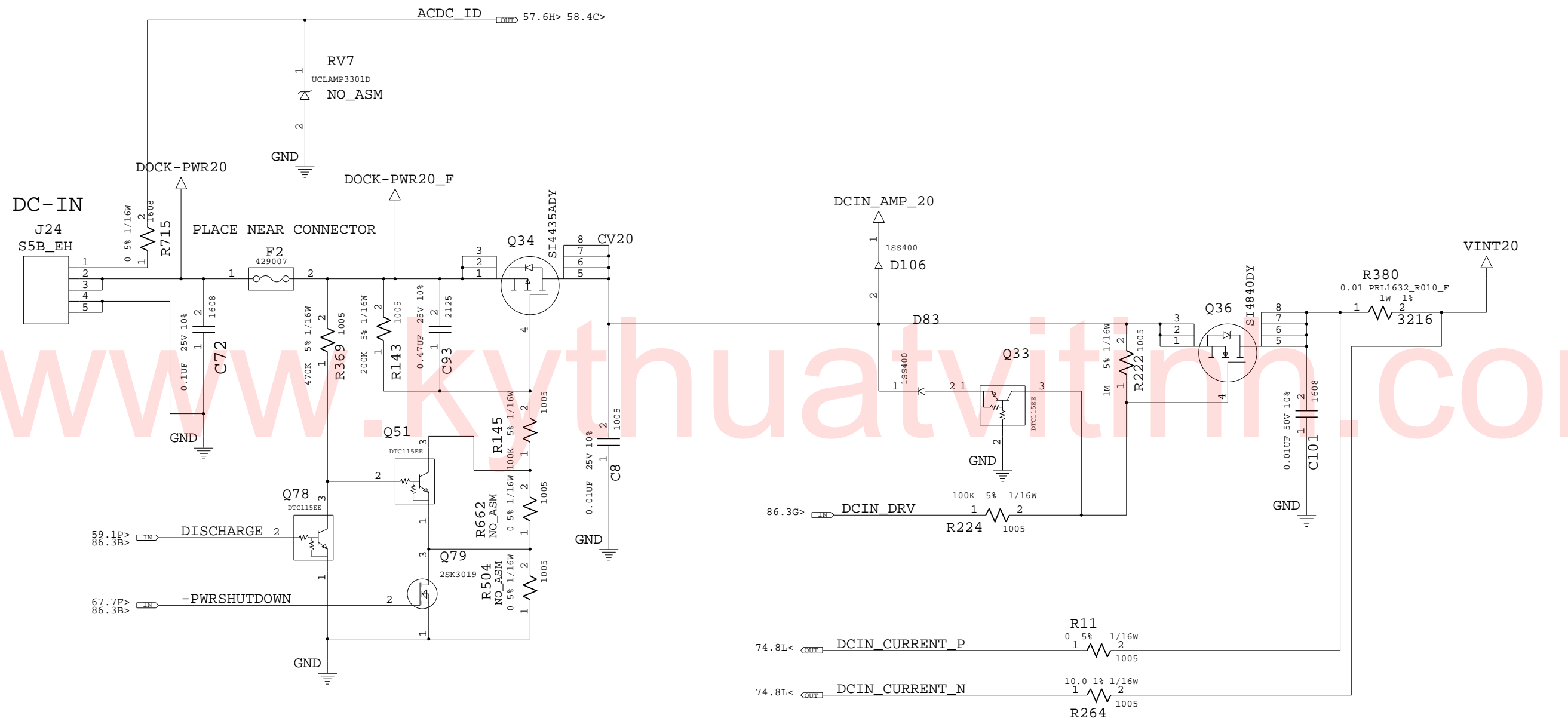

PEAK SHIFT	YES	NO
R504	NO-ASM	ASM
R369	ASM	NO-ASM
Q78	ASM	NO-ASM
Q79	ASM	NO-ASM

41W0930

DESIGNER	Y.Y	12/01/05	PART NO.	41W0930	
CHECKED	Y.I	12/01/05	TITLE	LISA-7(VER 5.04)	
APPROVED	T.S	12/01/05	CLASS	DC-IN	
THIS DOCUMENT IS THE PROPERTY OF IBM ITS USE IS AUTHORIZED ONLY FOR RESPONDING TO A REQUEST FOR QUOTATION OR FOR THE PERFORMANCE OF WORK FOR IBM. ALL QUESTIONS MUST BE REFERRED TO THE IBM PURCHASING DEPARTMENT.					LENOVO CONFIDENTIAL

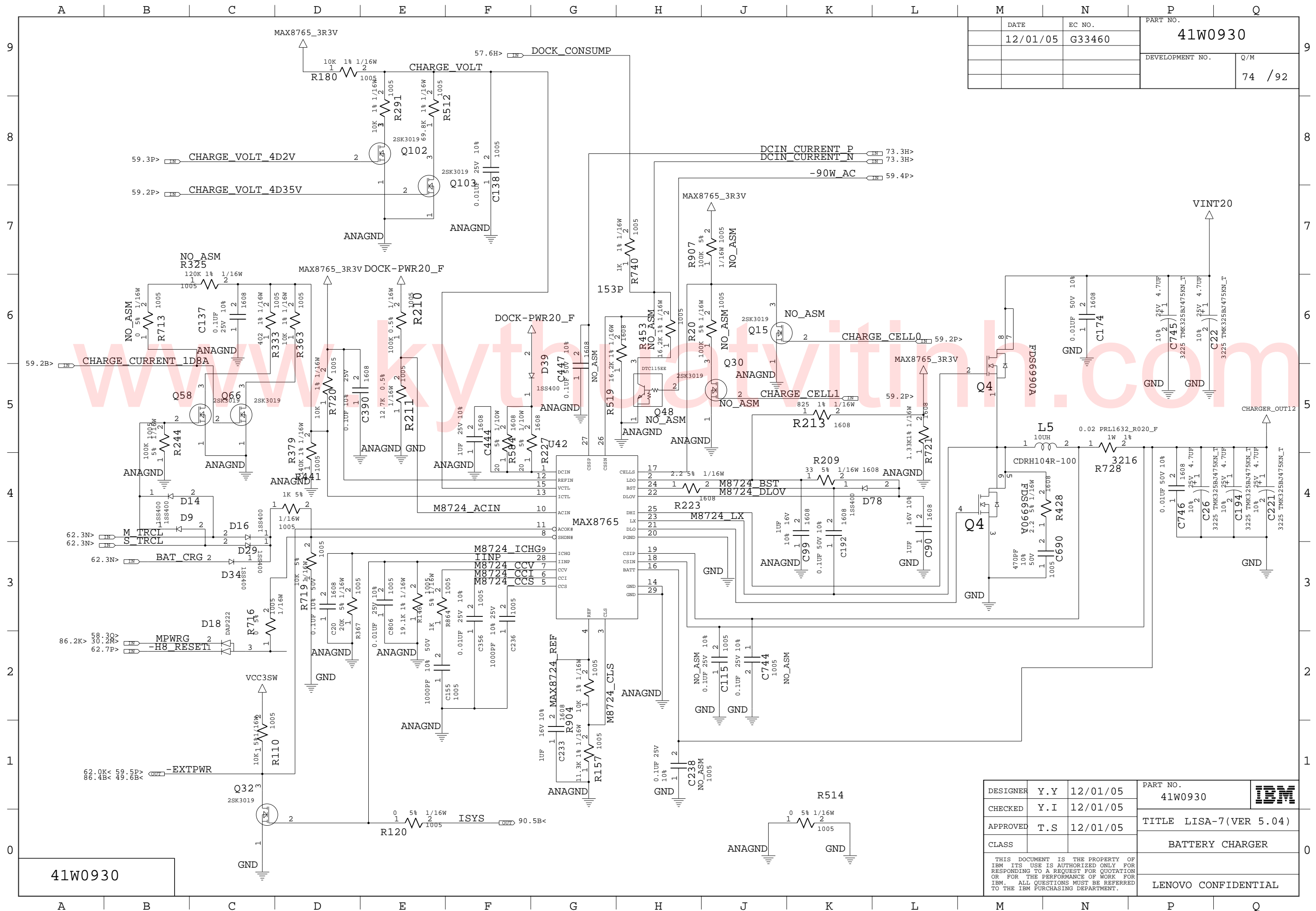

DATE	EC NO.	PART NO.
12/01/05	G33460	41W0930
DEVELOPMENT NO.		Q/M
		74 / 92

41W0930

DESIGNER	Y.Y	12/01/05	PART NO.	41W0930	
CHECKED	Y.I	12/01/05	TITLE LISA-7(VER 5.04)		
APPROVED	T.S	12/01/05	BATTERY CHARGER		
CLASS			LENOVO CONFIDENTIAL		

THIS DOCUMENT IS THE PROPERTY OF IBM ITS USE IS AUTHORIZED ONLY FOR RESPONDING TO A REQUEST FOR QUOTATION OR FOR THE PERFORMANCE OF WORK FOR IBM. ALL QUESTIONS MUST BE REFERRED TO THE IBM PURCHASING DEPARTMENT.

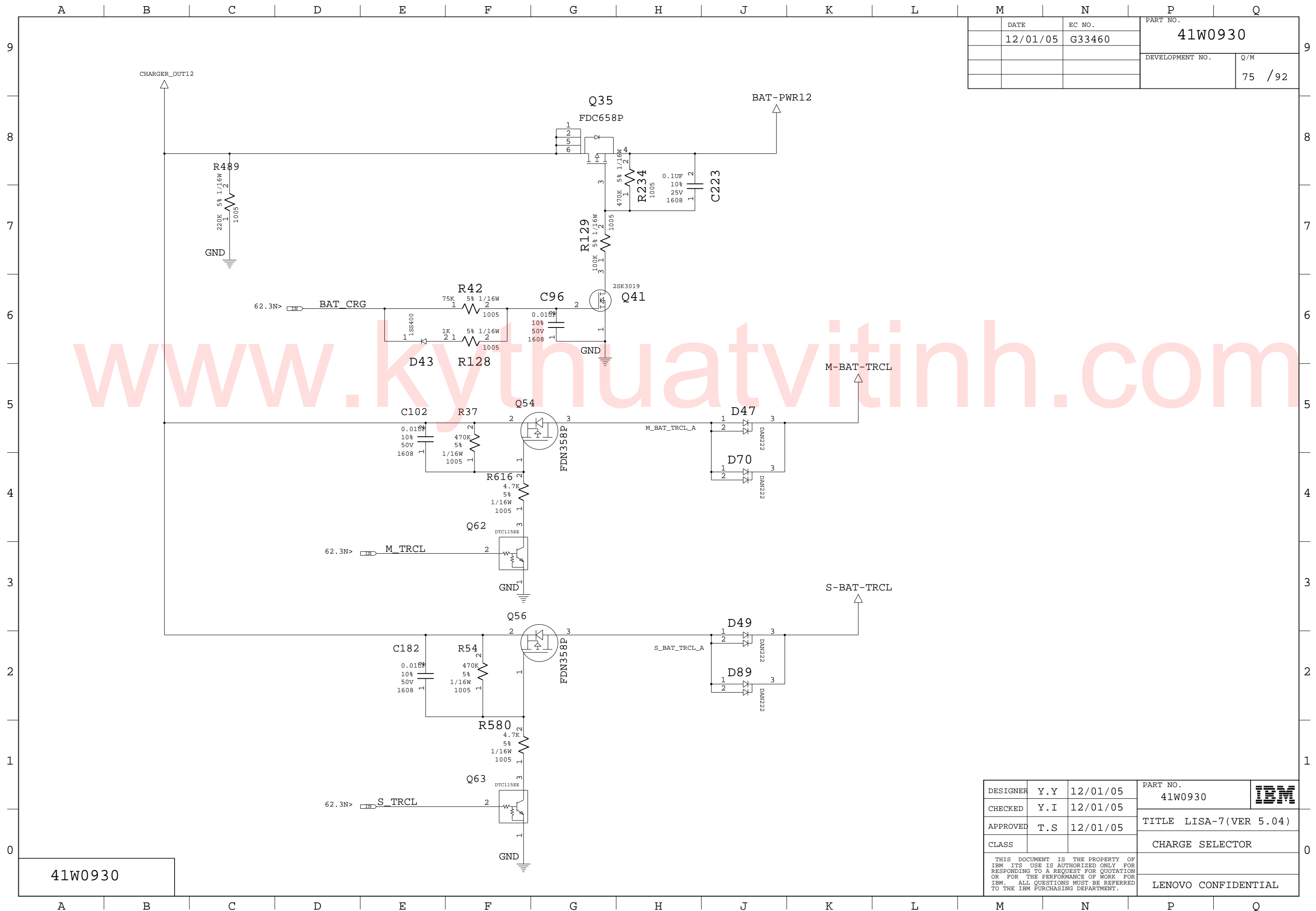

DATE	EC NO.	PART NO.	
12/01/05	G33460	41W0930	
		DEVELOPMENT NO.	Q/M
			75 / 92

41W0930

DESIGNER	Y.Y	12/01/05	PART NO.	41W0930	
CHECKED	Y.I	12/01/05			
APPROVED	T.S	12/01/05	TITLE LISA-7(VER 5.04)		
CLASS			CHARGE SELECTOR		
THIS DOCUMENT IS THE PROPERTY OF IBM ITS USE IS AUTHORIZED ONLY FOR RESPONDING TO A REQUEST FOR QUOTATION OR FOR THE PERFORMANCE OF WORK FOR IBM. ALL QUESTIONS MUST BE REFERRED TO THE IBM PURCHASING DEPARTMENT.					LENOVO CONFIDENTIAL

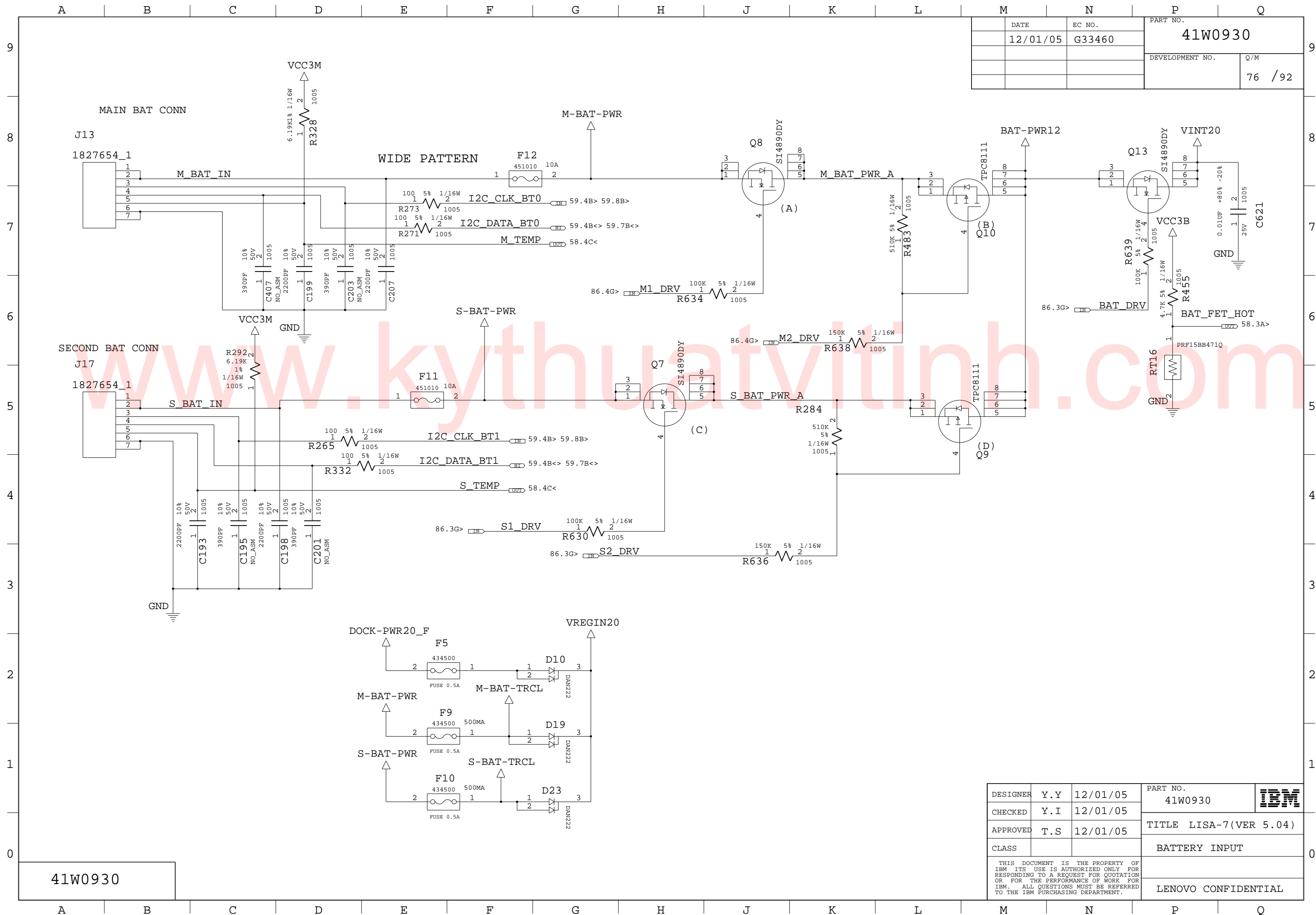

DATE	EC NO.	PART NO.
12/01/05	G33460	41W0930
DEVELOPMENT NO.		Q/M
		76 / 92

41W0930

DESIGNER	Y.Y	12/01/05	PART NO.	41W0930	
CHECKED	Y.I	12/01/05	TITLE LISA-7(VER 5.04)		
APPROVED	T.S	12/01/05	BATTERY INPUT		
CLASS			LENOVO CONFIDENTIAL		

THIS DOCUMENT IS THE PROPERTY OF IBM. ITS USE IS AUTHORIZED ONLY FOR RESPONDING TO A REQUEST FOR QUOTATION OR FOR THE PERFORMANCE OF WORK FOR IBM. ALL QUESTIONS MUST BE REFERRED TO THE IBM PURCHASING DEPARTMENT.

	DATE	EC NO.	PART NO.	
	12/01/05	G33460	41W0930	
			DEVELOPMENT NO.	Q/M
				77 / 92

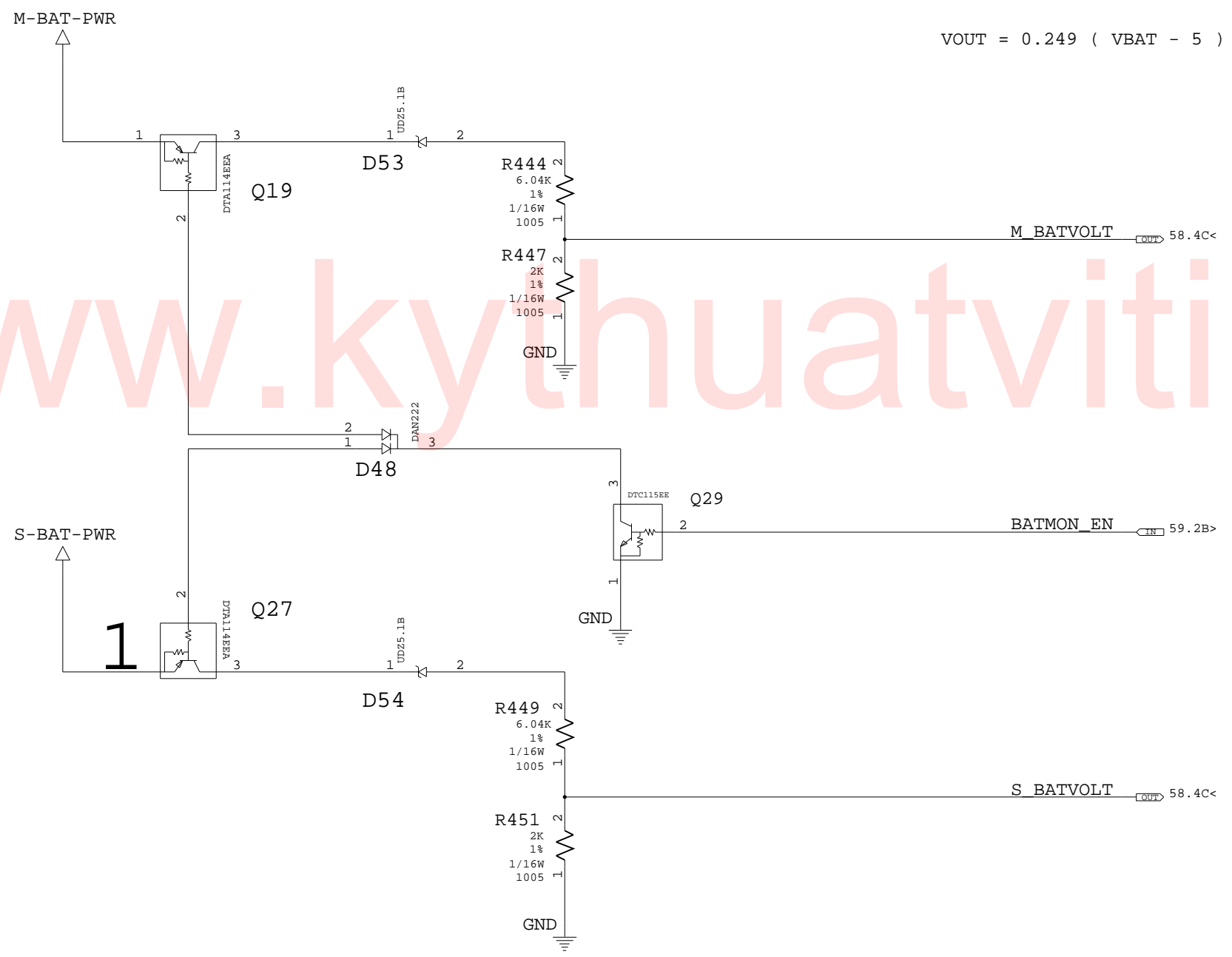

www.kyathuatvithinh.com

41W0930

DESIGNER	Y.Y	12/01/05	PART NO.	41W0930	IBM
CHECKED	Y.I	12/01/05			
APPROVED	T.S	12/01/05	TITLE LISA-7(VER 5.04)		
CLASS			BATTERY MONITOR		
THIS DOCUMENT IS THE PROPERTY OF IBM. ITS USE IS AUTHORIZED ONLY FOR RESPONDING TO A REQUEST FOR QUOTATION OR FOR THE PERFORMANCE OF WORK FOR IBM. ALL QUESTIONS MUST BE REFERRED TO THE IBM PURCHASING DEPARTMENT.				LENOVO CONFIDENTIAL	

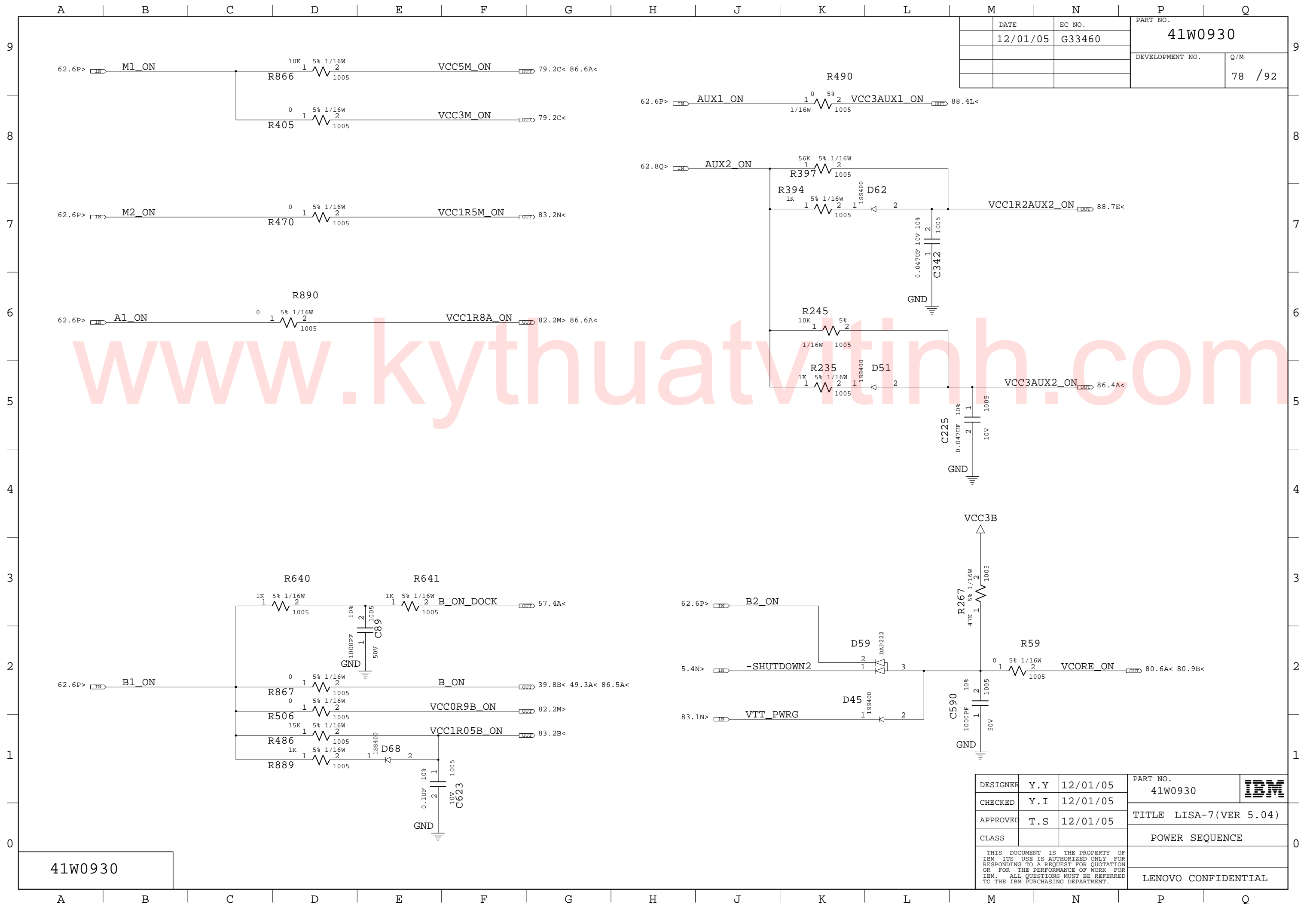

DATE	12/01/05	EC NO.	G33460	PART NO.	41W0930
DEVELOPMENT NO.				Q/M	78 / 92

41W0930

DESIGNER	Y.Y	12/01/05	PART NO.	41W0930	IBM
CHECKED	Y.I	12/01/05	TITLE LISA-7(VER 5.04)		
APPROVED	T.S	12/01/05	POWER SEQUENCE		
THIS DOCUMENT IS THE PROPERTY OF IBM. ITS USE IS AUTHORIZED ONLY FOR RESPONDING TO A REQUEST FOR QUOTATION OR FOR THE PERFORMANCE OF WORK FOR IBM. ALL QUESTIONS MUST BE REFERRED TO THE IBM PURCHASING DEPARTMENT.					LENOVO CONFIDENTIAL

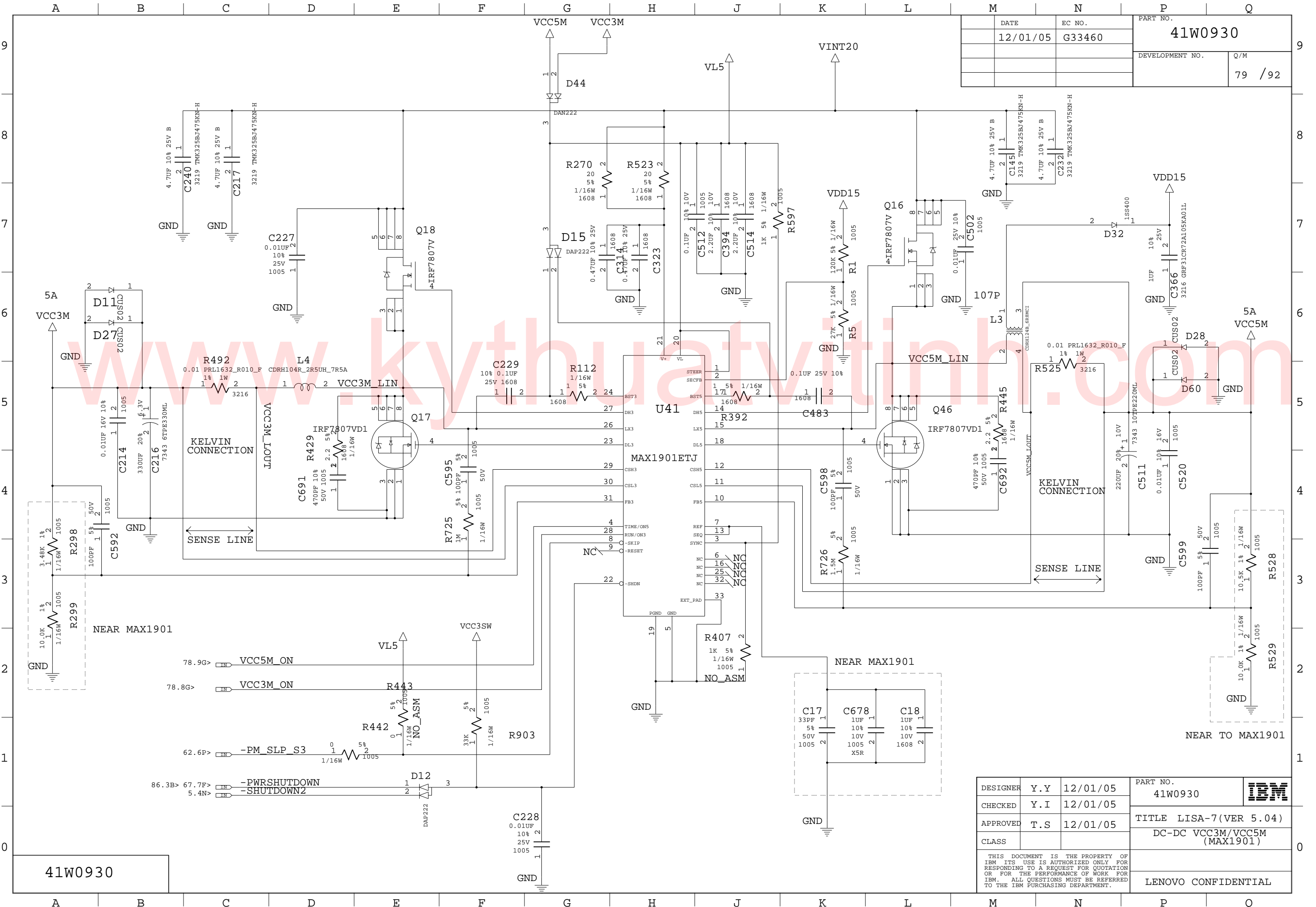

DATE	EC NO.	PART NO.
12/01/05	G33460	41W0930
DEVELOPMENT NO.		Q/M
		79 / 92

DESIGNER	Y.Y	12/01/05	PART NO.	41W0930	
CHECKED	Y.I	12/01/05	TITLE LISA-7(VER 5.04)		
APPROVED	T.S	12/01/05	DC-DC VCC3M/VCC5M (MAX1901)		
CLASS					
THIS DOCUMENT IS THE PROPERTY OF IBM ITS USE IS AUTHORIZED ONLY FOR RESPONDING TO A REQUEST FOR QUOTATION OR FOR THE PERFORMANCE OF WORK FOR IBM. ALL QUESTIONS MUST BE REFERRED TO THE IBM PURCHASING DEPARTMENT.					LENOVO CONFIDENTIAL

41W0930

DATE	EC NO.	PART NO.	
12/01/05	G33460	41W0930	
		DEVELOPMENT NO.	Q/M
			81 /92

9
8
7
6
5
4
3
2
1
0

FOLLOWING 7 PCS OF 0.47UF AREA ASM FOR VCCCPUCORE TO REDUCE EMI.

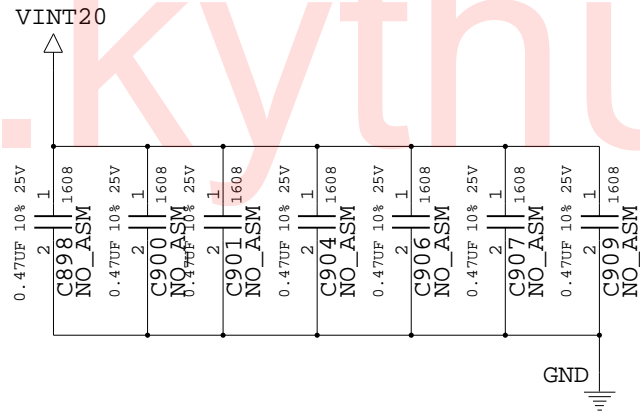

www.kythuatvithinh.com

41W0930

DESIGNER	Y.Y	12/01/05	PART NO.	41W0930	IBM
CHECKED	Y.I	12/01/05			
APPROVED	T.S	12/01/05	TITLE LISA-7(VER 5.04)		
CLASS			DC-DC VCORE INPUT CAP		
THIS DOCUMENT IS THE PROPERTY OF IBM ITS USE IS AUTHORIZED ONLY FOR RESPONDING TO A REQUEST FOR QUOTATION OR FOR THE PERFORMANCE OF WORK FOR IBM. ALL QUESTIONS MUST BE REFERRED TO THE IBM PURCHASING DEPARTMENT.				LENOVO CONFIDENTIAL	

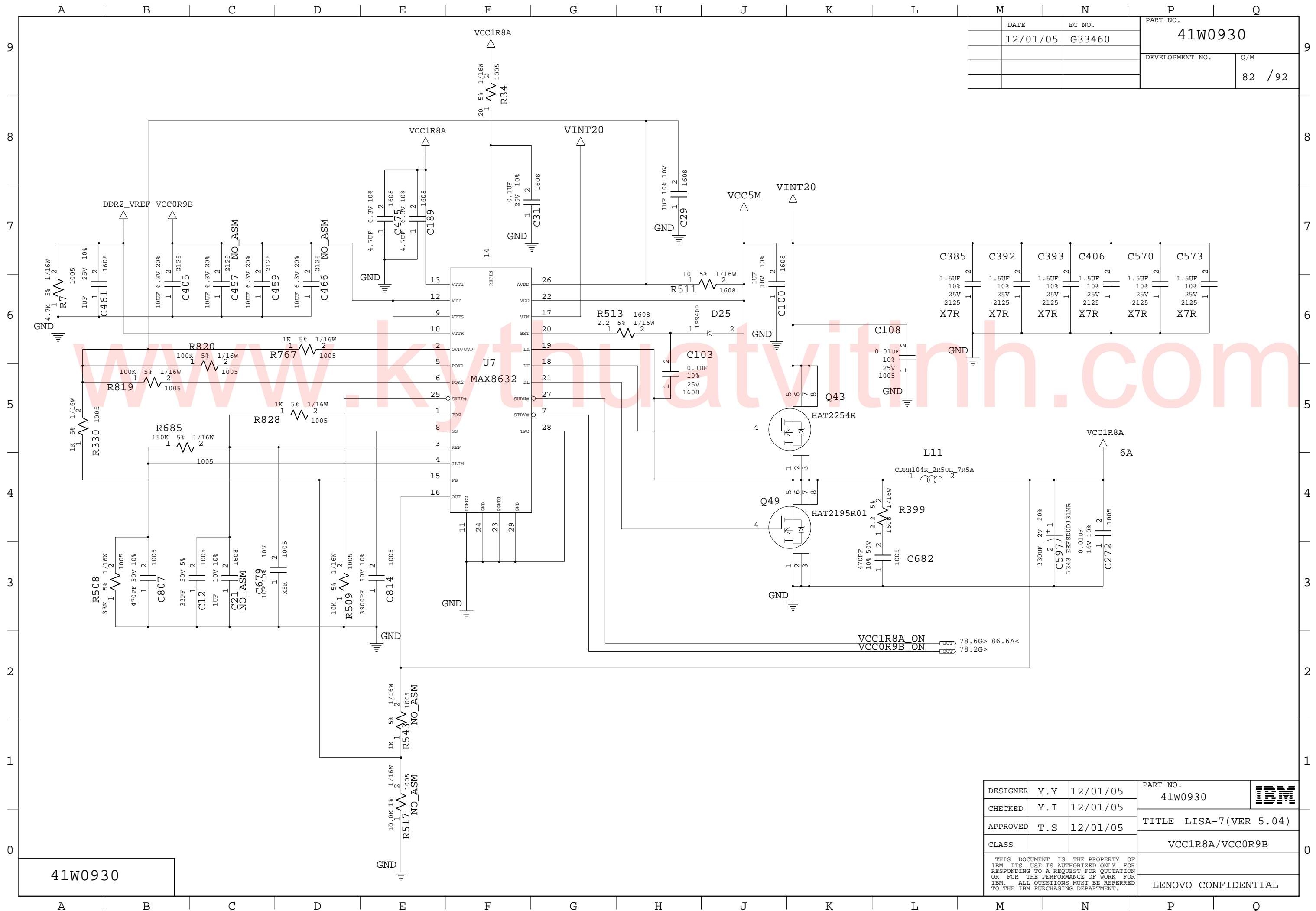

DATE	12/01/05	EC NO.	G33460	PART NO.	41W0930
DEVELOPMENT NO.		Q/M	82 / 92		

41W0930

DESIGNER	Y.Y	12/01/05	PART NO.	41W0930	
CHECKED	Y.I	12/01/05	TITLE	LISA-7(VER 5.04)	
APPROVED	T.S	12/01/05		VCC1R8A/VCC0R9B	
CLASS			THIS DOCUMENT IS THE PROPERTY OF IBM. ITS USE IS AUTHORIZED ONLY FOR RESPONDING TO A REQUEST FOR QUOTATION OR FOR THE PERFORMANCE OF WORK FOR IBM. ALL QUESTIONS MUST BE REFERRED TO THE IBM PURCHASING DEPARTMENT.		
					LENOVO CONFIDENTIAL

DATE	EC NO.	PART NO.	
12/01/05	G33460	41W0930	
		DEVELOPMENT NO.	Q/M
			83 / 92

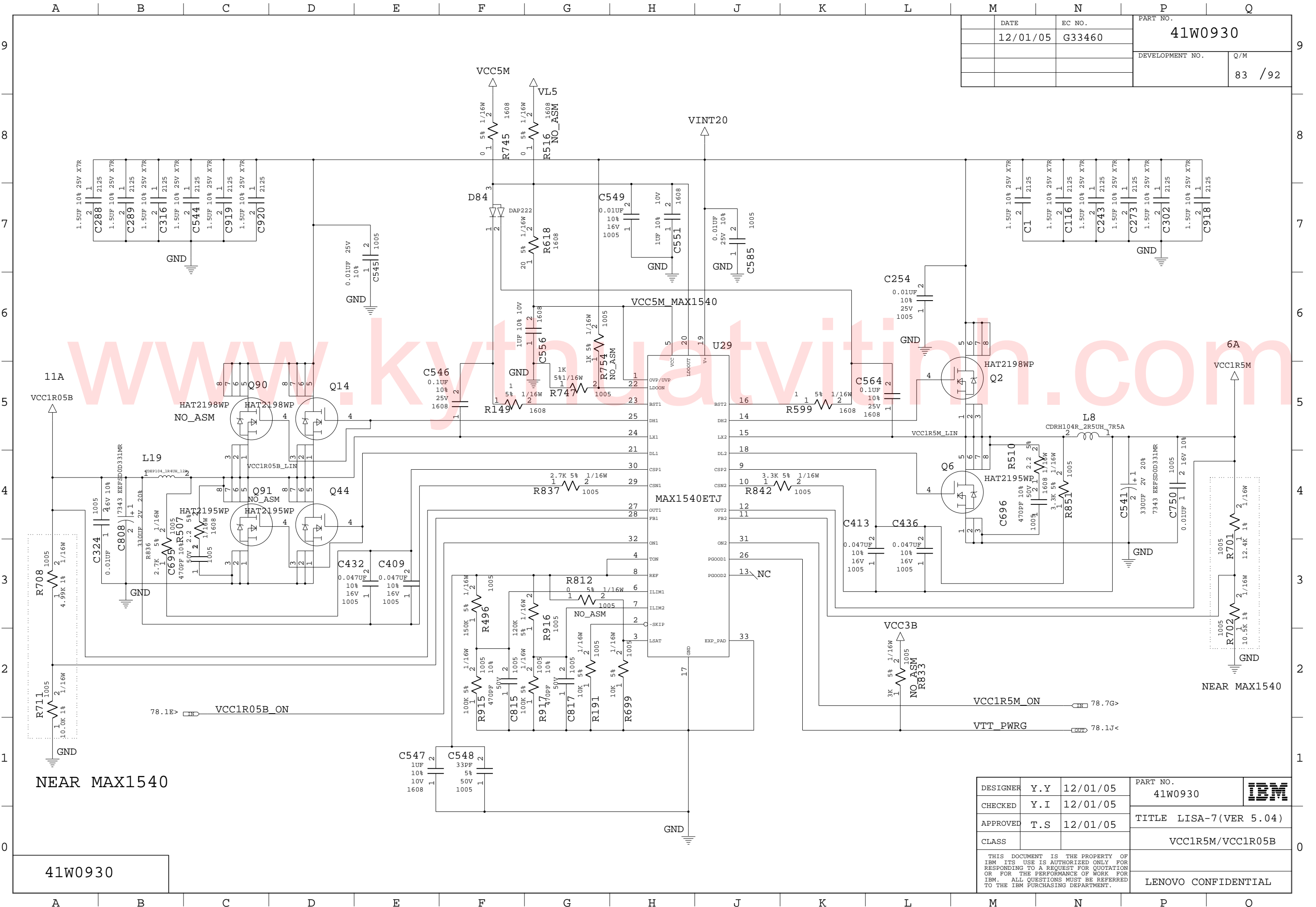

NEAR MAX1540

NEAR MAX1540

41W0930

DESIGNER	Y.Y	12/01/05	PART NO.	41W0930	
CHECKED	Y.I	12/01/05	TITLE LISA-7(VER 5.04)		
APPROVED	T.S	12/01/05	CLASS VCC1R5M/VCC1R05B		
THIS DOCUMENT IS THE PROPERTY OF IBM ITS USE IS AUTHORIZED ONLY FOR RESPONDING TO A REQUEST FOR QUOTATION OR FOR THE PERFORMANCE OF WORK FOR IBM. ALL QUESTIONS MUST BE REFERRED TO THE IBM PURCHASING DEPARTMENT.					LENOVO CONFIDENTIAL

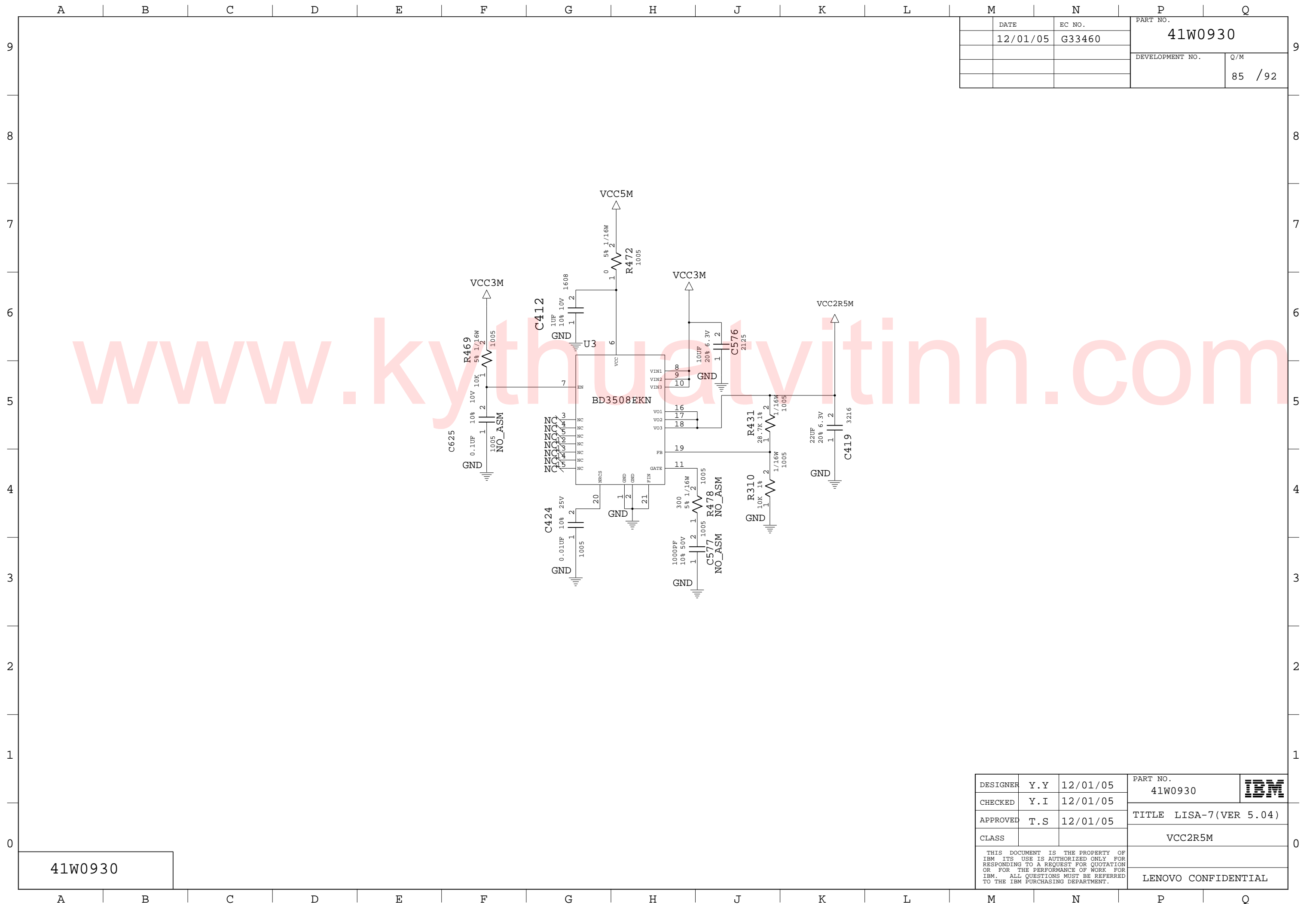

DATE	EC NO.	PART NO.	
12/01/05	G33460	41W0930	
		DEVELOPMENT NO.	Q/M
			85 /92

41W0930

DESIGNER	Y.Y	12/01/05	PART NO.	41W0930	
CHECKED	Y.I	12/01/05	TITLE		
APPROVED	T.S	12/01/05	CLASS	VCC2R5M	
THIS DOCUMENT IS THE PROPERTY OF IBM ITS USE IS AUTHORIZED ONLY FOR RESPONDING TO A REQUEST FOR QUOTATION OR FOR THE PERFORMANCE OF WORK FOR IBM. ALL QUESTIONS MUST BE REFERRED TO THE IBM PURCHASING DEPARTMENT.					LENOVO CONFIDENTIAL

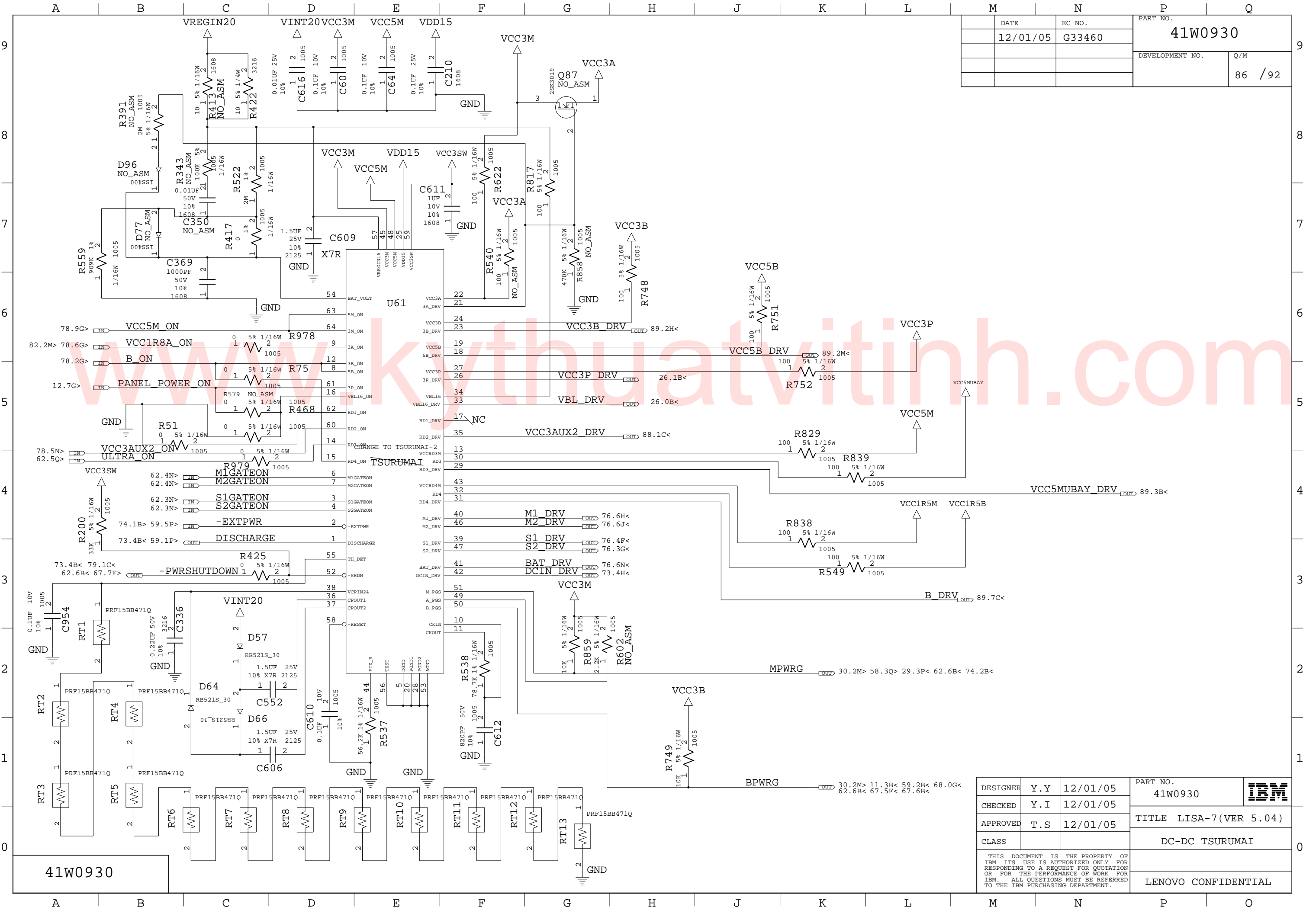

DATE	12/01/05	EC NO.	G33460	PART NO.	41W0930
DEVELOPMENT NO.				Q/M	86 / 92

41W0930

DESIGNER	Y.Y	12/01/05	PART NO.	41W0930	
CHECKED	Y.I	12/01/05	TITLE	LISA-7(VER 5.04)	
APPROVED	T.S	12/01/05	DC-DC TSURUMAI		
CLASS	LENOVO CONFIDENTIAL				

THIS DOCUMENT IS THE PROPERTY OF IBM. ITS USE IS AUTHORIZED ONLY FOR RESPONDING TO A REQUEST FOR QUOTATION OR FOR THE PERFORMANCE OF WORK FOR IBM. ALL QUESTIONS MUST BE REFERRED TO THE IBM PURCHASING DEPARTMENT.

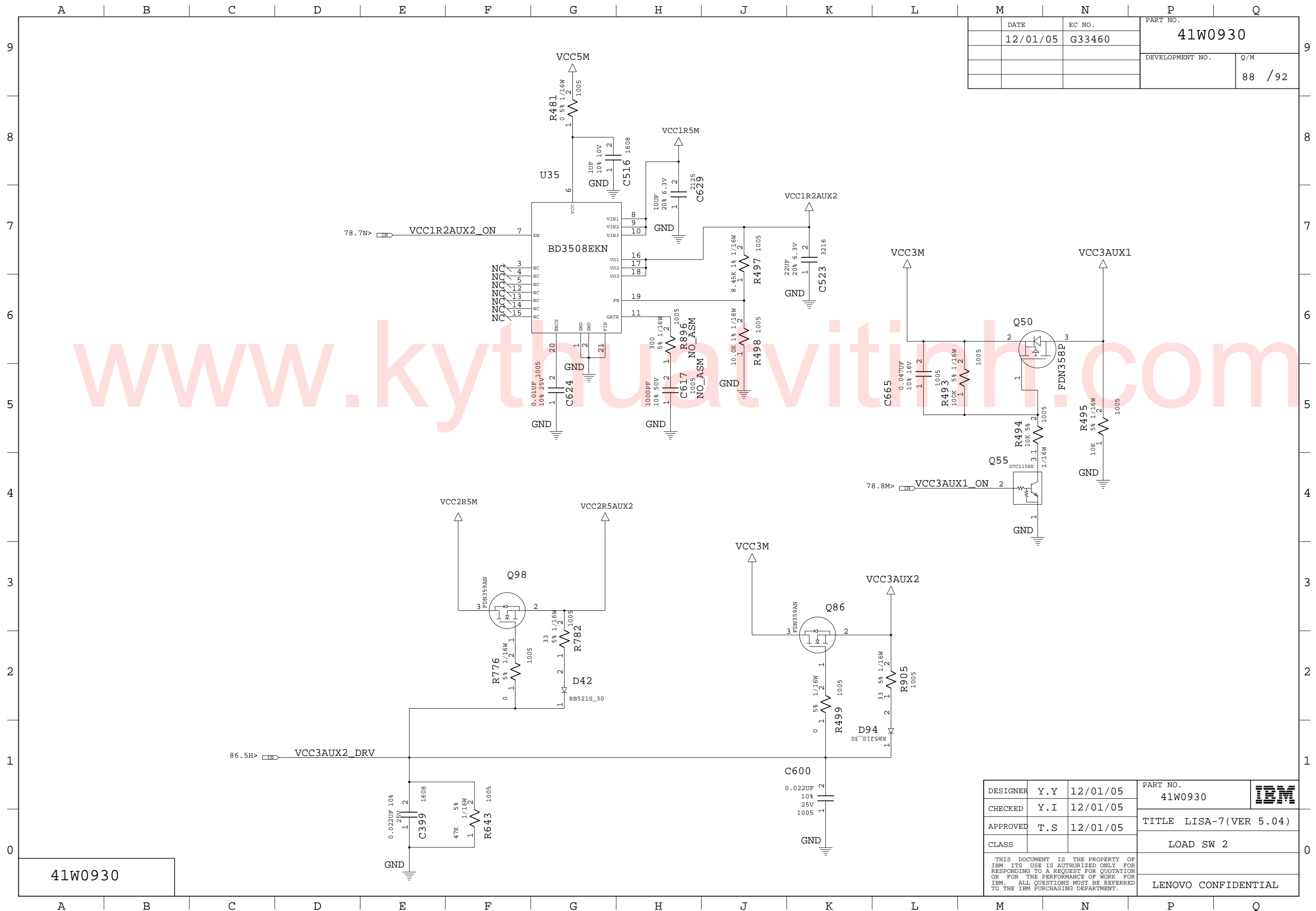

DATE	EC NO.	PART NO.	
12/01/05	G33460	41W0930	
		DEVELOPMENT NO.	Q/M
			88 / 92

41W0930

DESIGNER	Y.Y	12/01/05	PART NO.	41W0930	IBM
CHECKED	Y.I	12/01/05			
APPROVED	T.S	12/01/05	TITLE LISA-7(VER 5.04)		
CLASS			LOAD SW 2		
THIS DOCUMENT IS THE PROPERTY OF IBM. ITS USE IS AUTHORIZED ONLY FOR RESPONDING TO A REQUEST FOR QUOTATION OR FOR THE PERFORMANCE OF WORK FOR IBM. ALL QUESTIONS MUST BE REFERRED TO THE IBM PURCHASING DEPARTMENT.					LENOVO CONFIDENTIAL

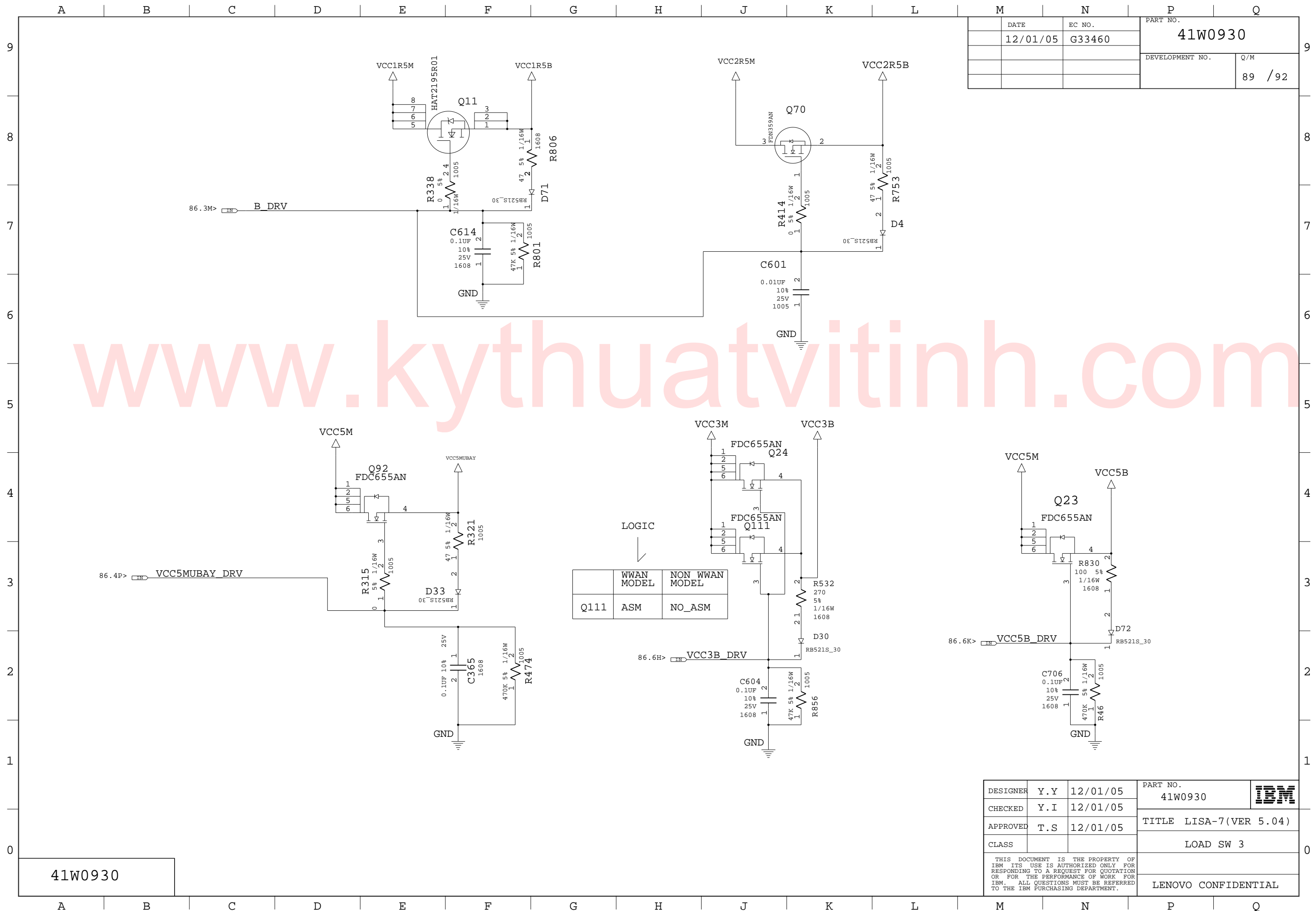

DATE	EC NO.	PART NO.	
12/01/05	G33460	41W0930	
		DEVELOPMENT NO.	Q/M
			89 / 92

41W0930

DESIGNER	Y.Y	12/01/05	PART NO.	41W0930	IBM
CHECKED	Y.I	12/01/05	TITLE LISA-7(VER 5.04)		
APPROVED	T.S	12/01/05	LOAD SW 3		
CLASS					
THIS DOCUMENT IS THE PROPERTY OF IBM ITS USE IS AUTHORIZED ONLY FOR RESPONDING TO A REQUEST FOR QUOTATION OR FOR THE PERFORMANCE OF WORK FOR IBM. ALL QUESTIONS MUST BE REFERRED TO THE IBM PURCHASING DEPARTMENT.					LENOVO CONFIDENTIAL

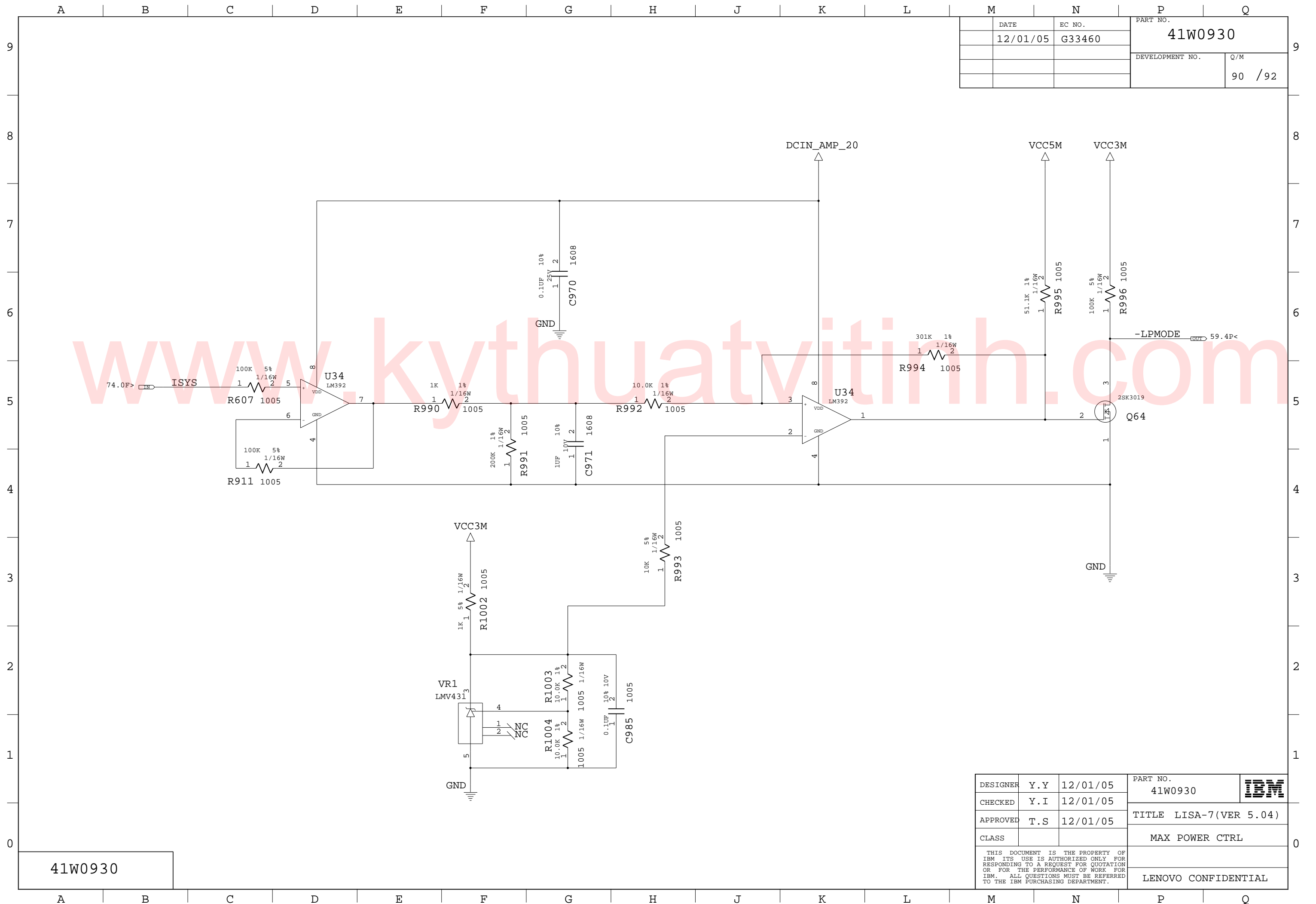

DATE	12/01/05	EC NO.	G33460	PART NO.	41W0930
				DEVELOPMENT NO.	90 / 92

41W0930

DESIGNER	Y.Y	12/01/05	PART NO.	41W0930	IBM
CHECKED	Y.I	12/01/05	TITLE LISA-7(VER 5.04)		
APPROVED	T.S	12/01/05	MAX POWER CTRL		
CLASS			LENOVO CONFIDENTIAL		
<small>THIS DOCUMENT IS THE PROPERTY OF IBM ITS USE IS AUTHORIZED ONLY FOR RESPONDING TO A REQUEST FOR QUOTATION OR FOR THE PERFORMANCE OF WORK FOR IBM. ALL QUESTIONS MUST BE REFERRED TO THE IBM PURCHASING DEPARTMENT.</small>					

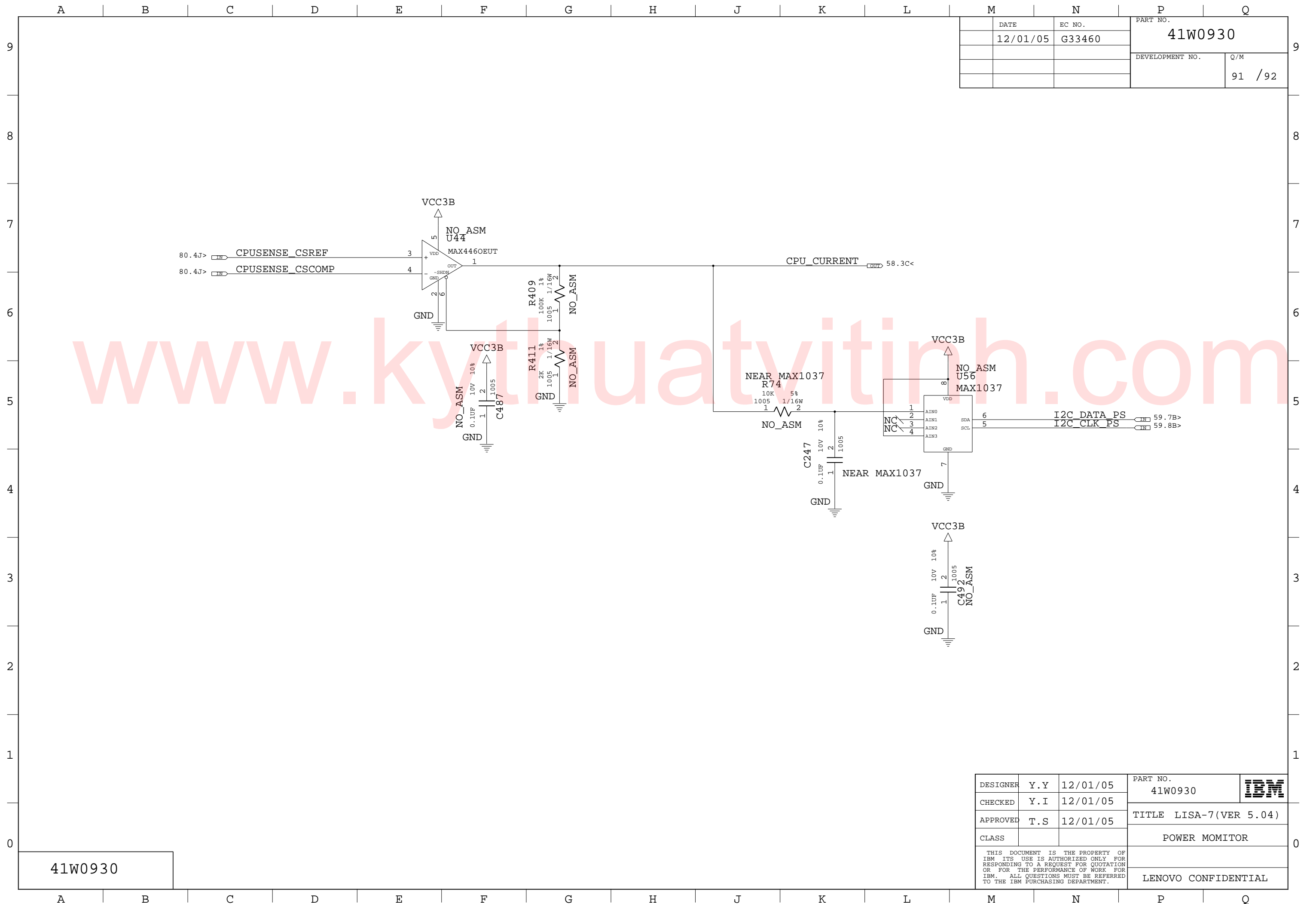

DATE	EC NO.	PART NO.	
12/01/05	G33460	41W0930	
		DEVELOPMENT NO.	Q/M
			91 / 92

41W0930

DESIGNER	Y.Y	12/01/05	PART NO.	41W0930	IBM
CHECKED	Y.I	12/01/05			
APPROVED	T.S	12/01/05	TITLE LISA-7(VER 5.04)		
CLASS			POWER MOMITOR		
THIS DOCUMENT IS THE PROPERTY OF IBM. ITS USE IS AUTHORIZED ONLY FOR RESPONDING TO A REQUEST FOR QUOTATION OR FOR THE PERFORMANCE OF WORK FOR IBM. ALL QUESTIONS MUST BE REFERRED TO THE IBM PURCHASING DEPARTMENT.					LENOVO CONFIDENTIAL

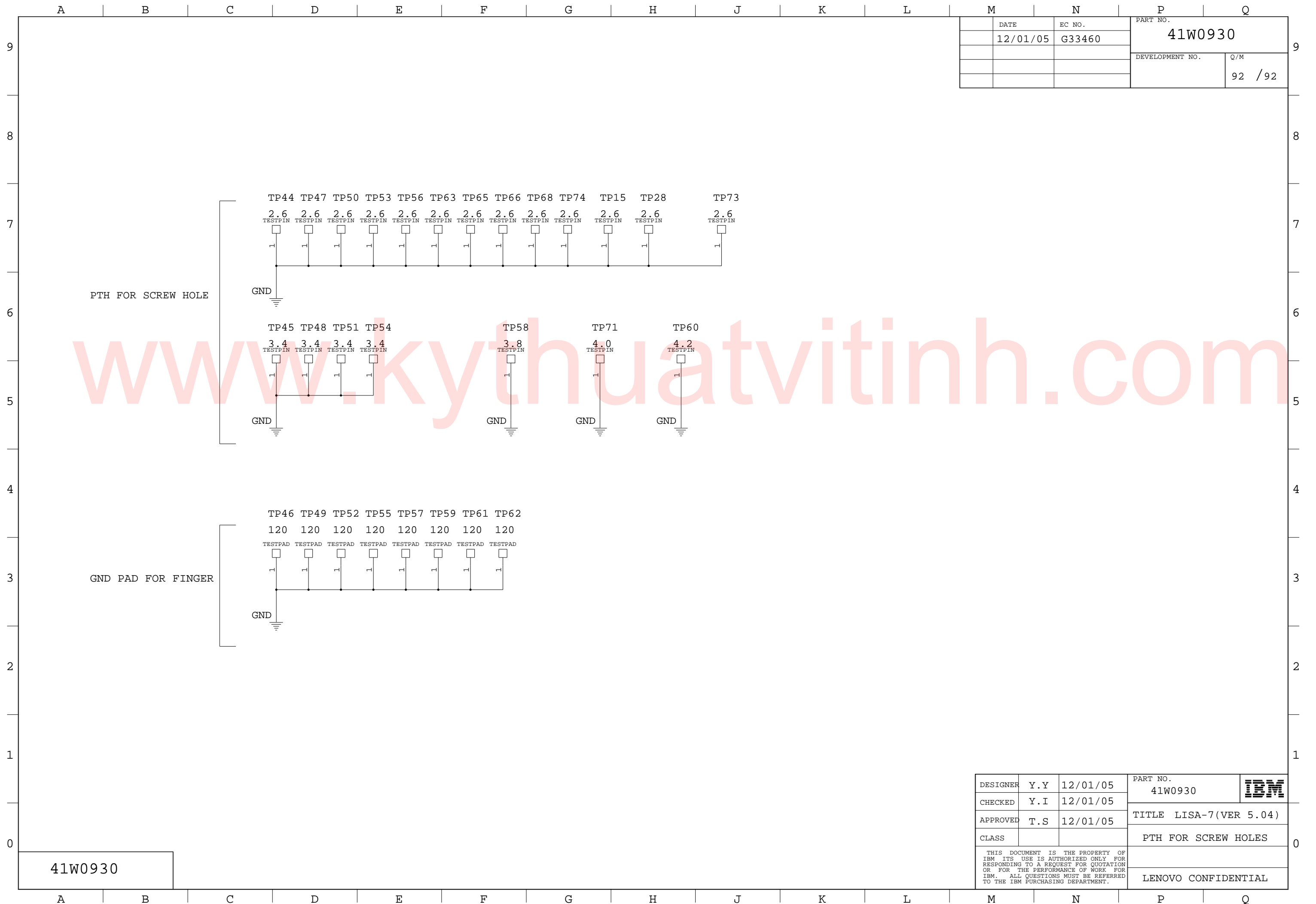

DATE	EC NO.	PART NO.	
12/01/05	G33460	41W0930	
		DEVELOPMENT NO.	Q/M
			92 / 92

41W0930

DESIGNER	Y.Y	12/01/05	PART NO.	41W0930	IBM
CHECKED	Y.I	12/01/05			
APPROVED	T.S	12/01/05	TITLE LISA-7(VER 5.04)		
CLASS			PTH FOR SCREW HOLES		
THIS DOCUMENT IS THE PROPERTY OF IBM ITS USE IS AUTHORIZED ONLY FOR RESPONDING TO A REQUEST FOR QUOTATION OR FOR THE PERFORMANCE OF WORK FOR IBM. ALL QUESTIONS MUST BE REFERRED TO THE IBM PURCHASING DEPARTMENT.				LENOVO CONFIDENTIAL	