

7. CIRCUIT DIAGRAM

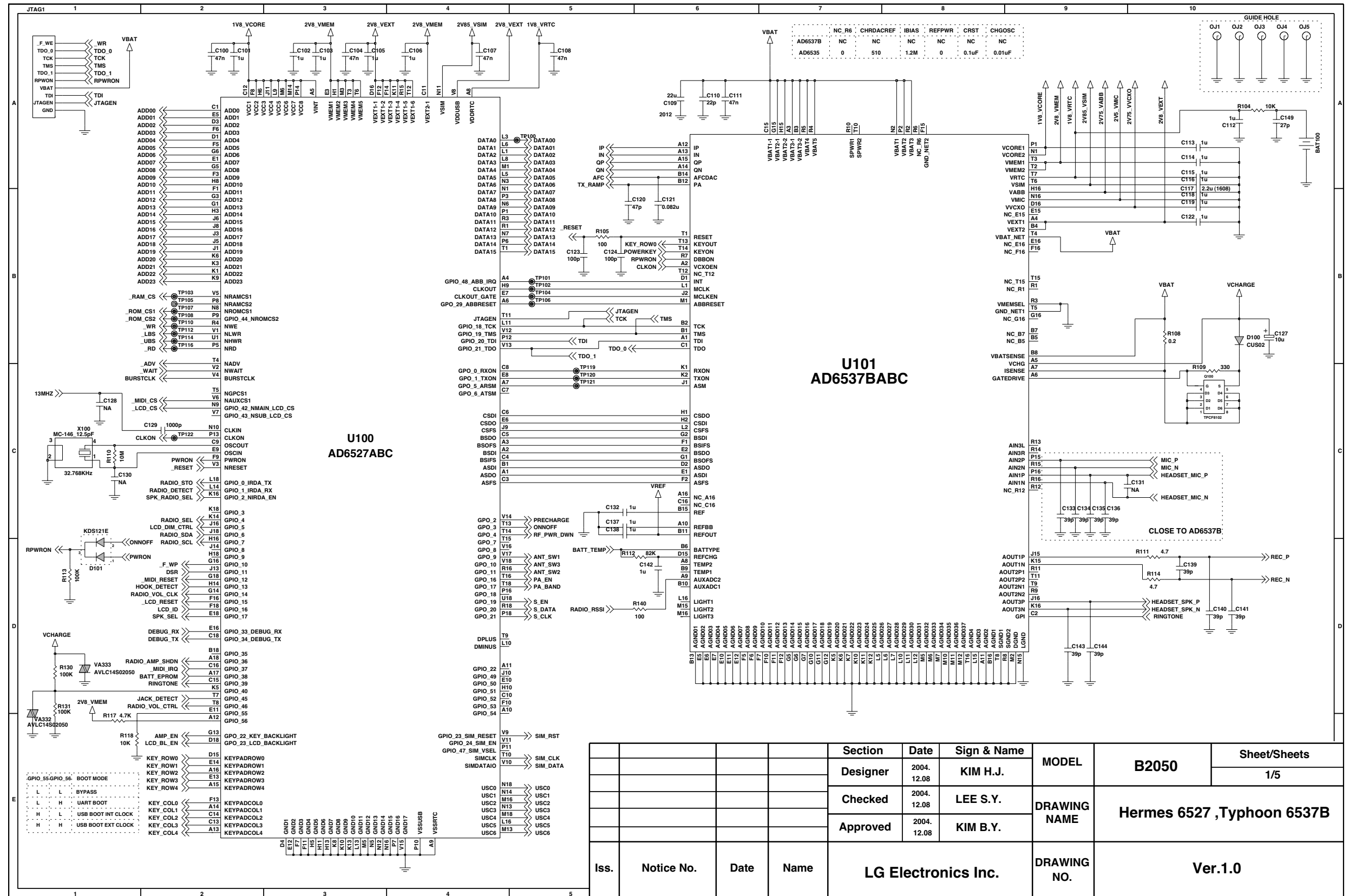

LGIC(42)-A-5505-10:01

LG Electronics Inc.

7. CIRCUIT DIAGRAM

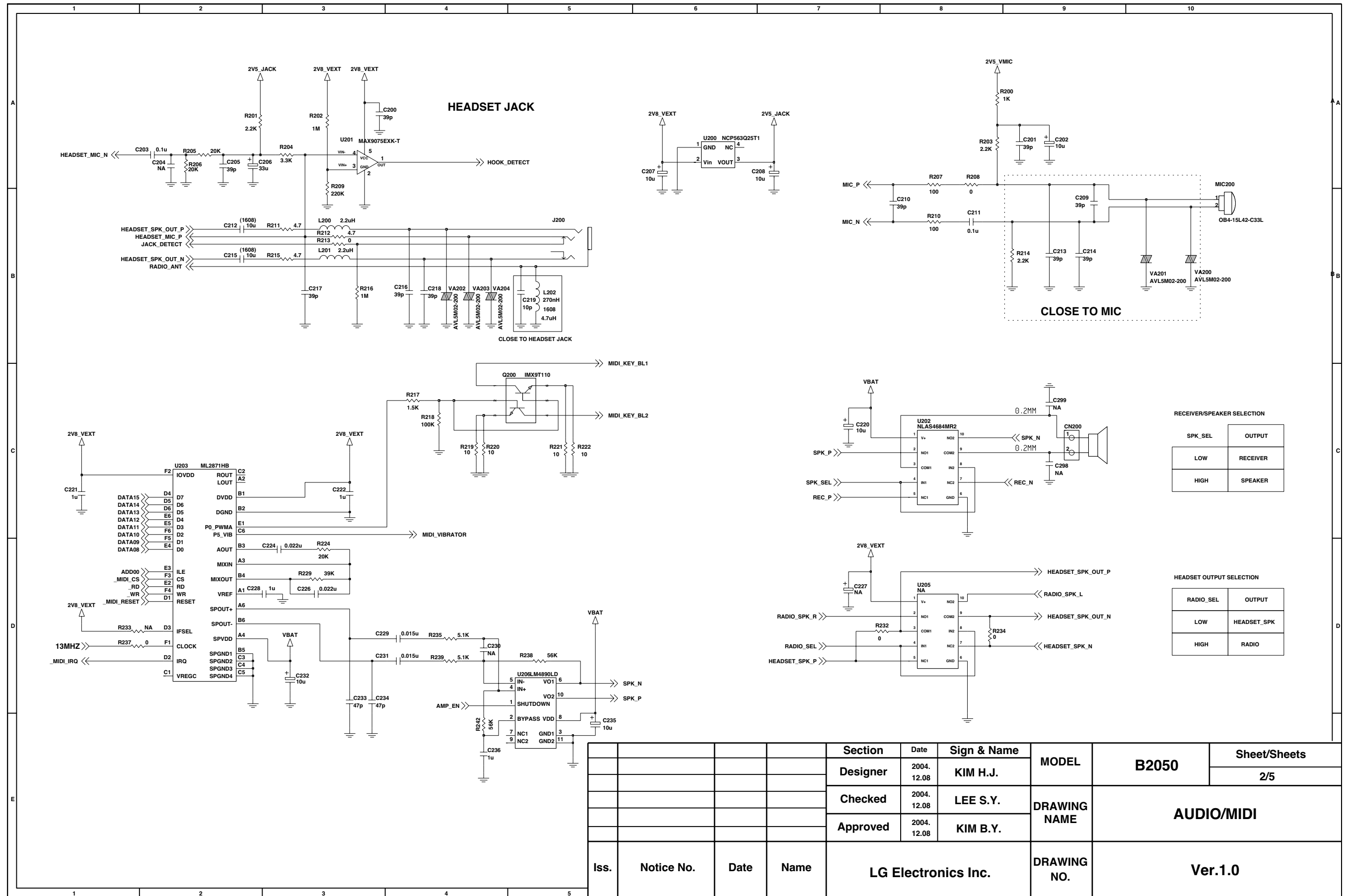

					Section	Date	Sign & Name	MODEL	B2050	Sheet/Sheets
					Designer	2004.12.08	KIM H.J.			2/5
					Checked	2004.12.08	LEE S.Y.	DRAWING NAME	AUDIO/MIDI	
					Approved	2004.12.08	KIM B.Y.			
Iss.	Notice No.	Date	Name		LG Electronics Inc.			DRAWING NO.	Ver.1.0	

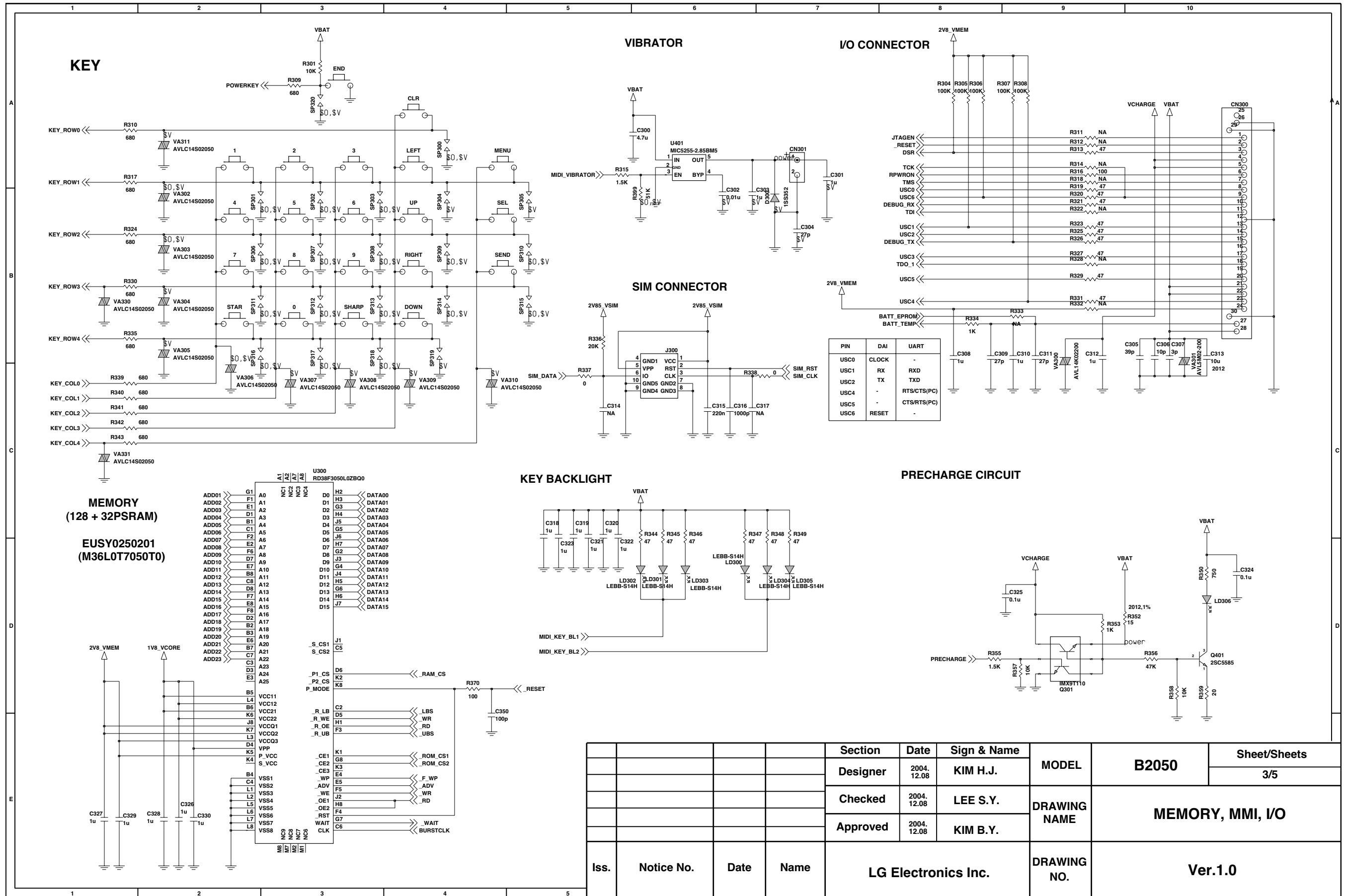

7. CIRCUIT DIAGRAM

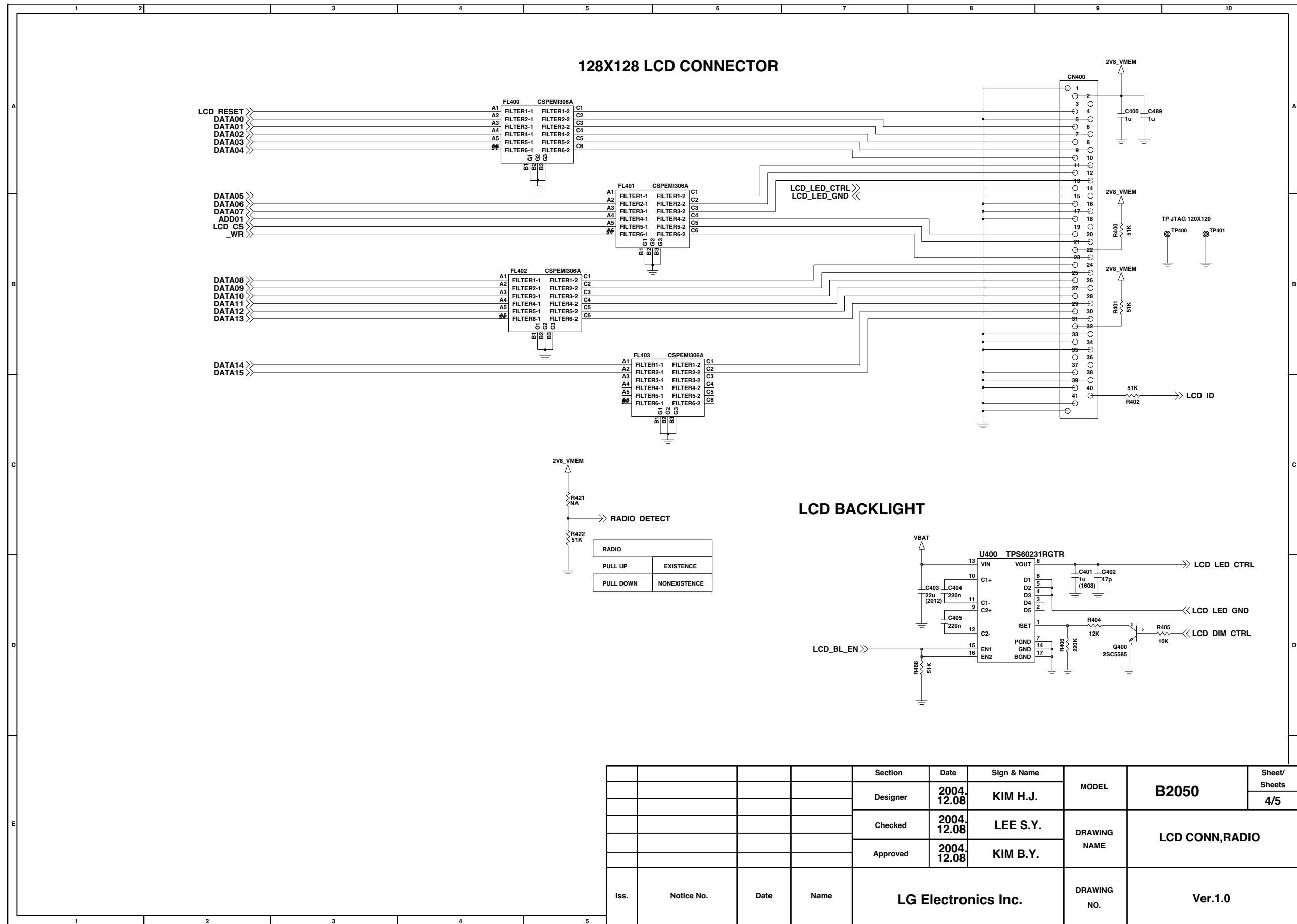

Section	Date	Sign & Name	MODEL	Sheet/ Sheets	
Designer	2004.12.08	KIM H.J.	B2050	4/5	
Checked	2004.12.08	LEE S.Y.	DRAWING NAME	LCD CONN,RADIO	
Approved	2004.12.08	KIM B.Y.			
Iss.	Notice No.	Date	Name	DRAWING NO.	Ver.1.0

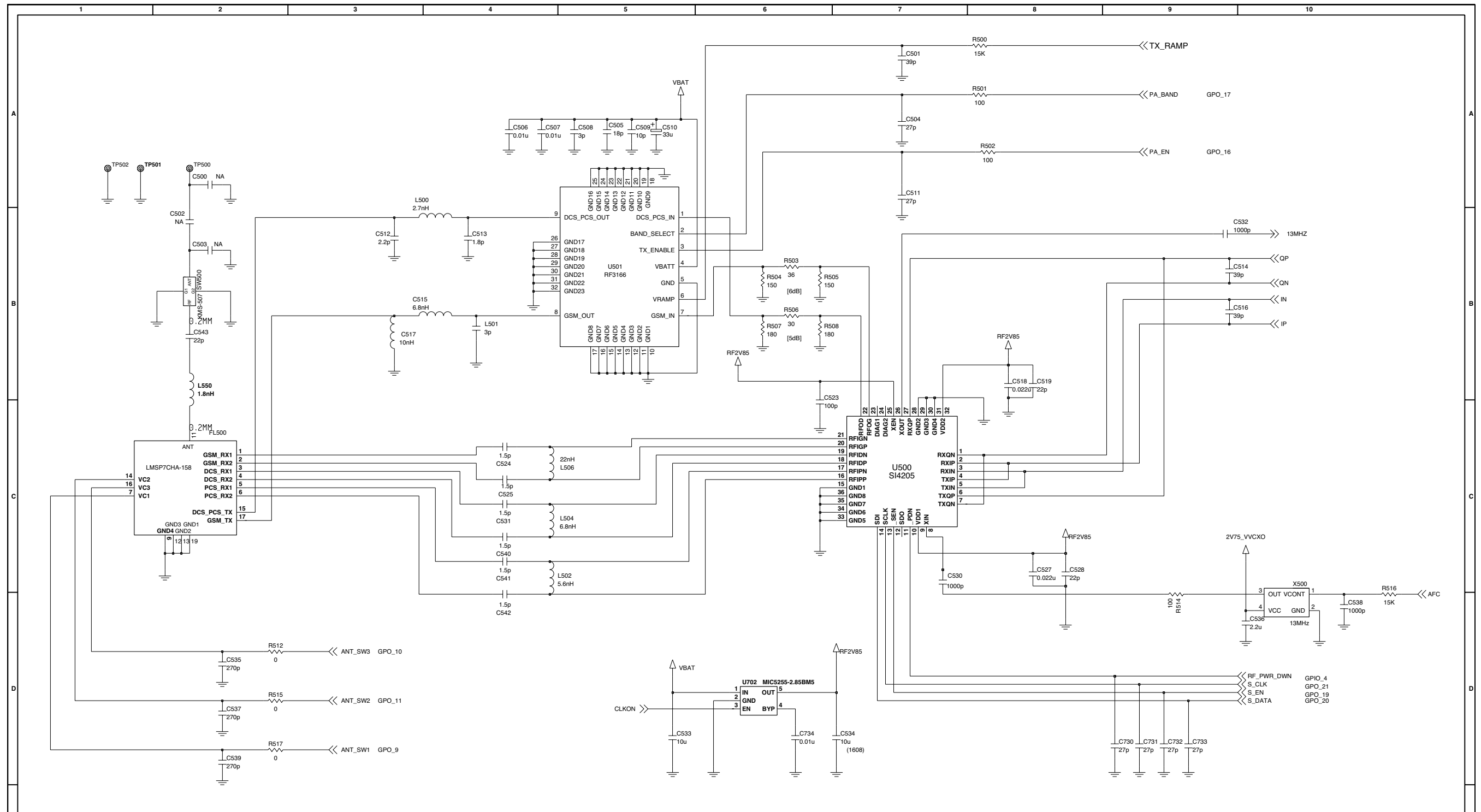

ANT SW CONTROL TABLE

	VC1	VC2	VC3
EGSM_TX	L	L H	
DCS/PCS_TX	L	H	L
EGSM/DCS_RX	L	L	L
PCS_Rx	H	L	L

				Section	Date	Sign & Name	MODEL	B2050	Sheet/Sheets
				Designer	2004.12.08	KIM Y.G.			
				Checked	2004.12.08	LEE S.Y.	DRAWING NAME	RF	
				Approved	2004.12.08	KIM B.Y.			
Iss.	Notice No.	Date	Name	LG Electronics Inc.			DRAWING NO.	Ver.1.0	

8. PCB LAYOUT

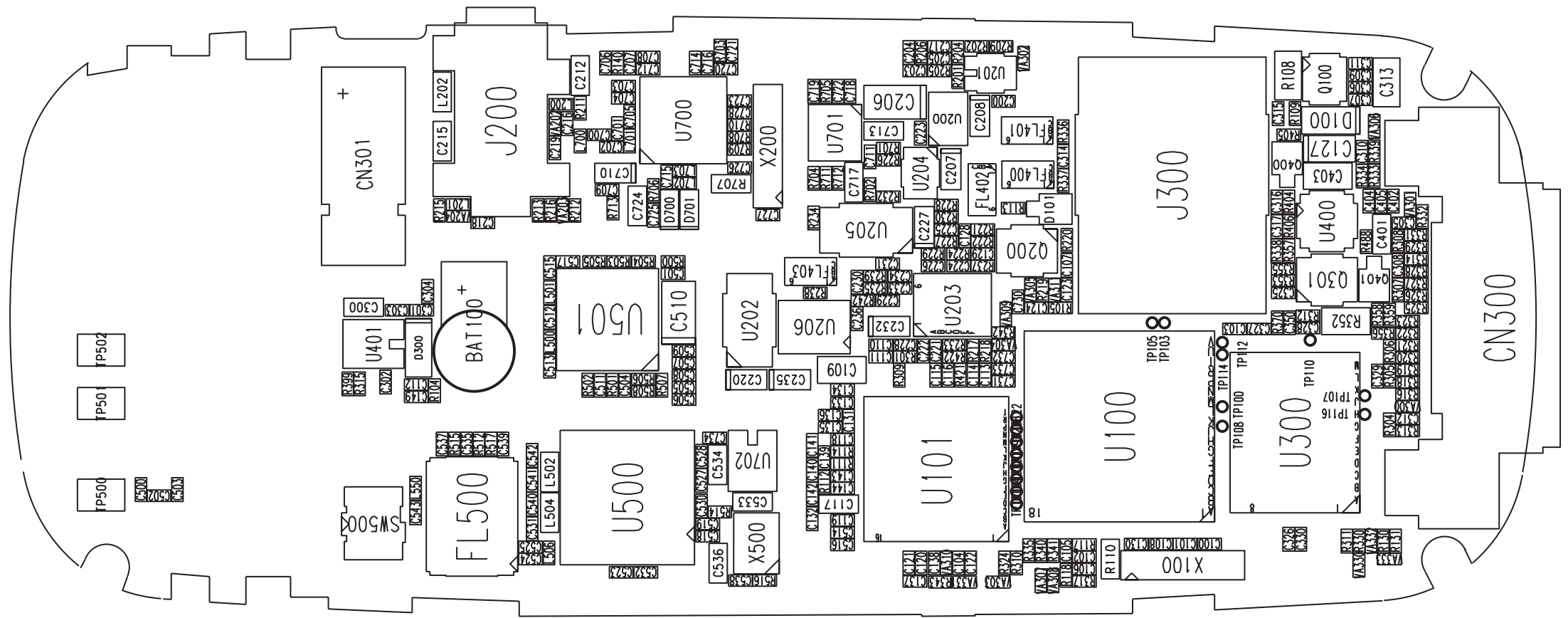

Figure 8-1 B2050 BOTTOM SIDE PCB LAYOUT

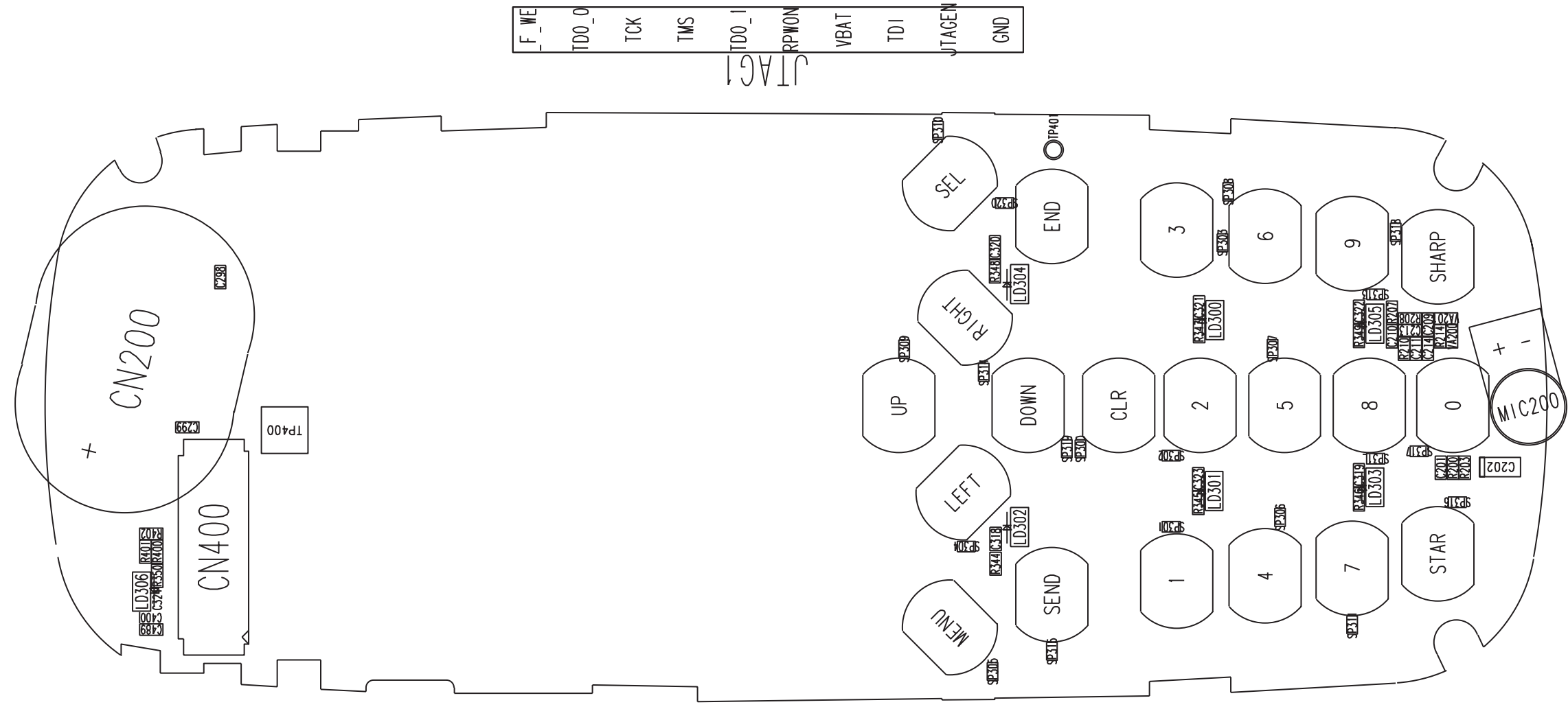

Figure 8-1 B2050 TOP SIDE PCB LAYOUT