

A7V8X

Revision : 1.04

版本: R1.04

RD: 邱明達

日期: 91.8



ATX Power

+5VSB	+12V
+3.3V	-5V
+5V	-12V

PAGE: 1

CPU DC/DC

ST L6917B
INPUT OUTPUT
+12V +1.85V-1.1V

PAGE: 5

System Regulator

INPUT	OUTPUT
+5VSB	+3VSB
+3V	+1.8V
+3V	VDDQ
+3V	+3V_DUAL
+3VSB	+3V_DUAL
+3V_DUAL	+2.5V_DUAL
+2.5V_DUAL	VTT_DDR

PAGE: 4

PCB LAYER

L1: Component (S1)
L2: GND
L3: VCC
L4: Component (S4)

<Core Design>

ASUS		Title: BLOC
Asustek Computer INC.		Engineer: Oster Chiou
Size: A4	Project Name: A7V8X	Rev: 0.1
Date: 星期六, 八月 17, 2002	Sheet: 1	of 38

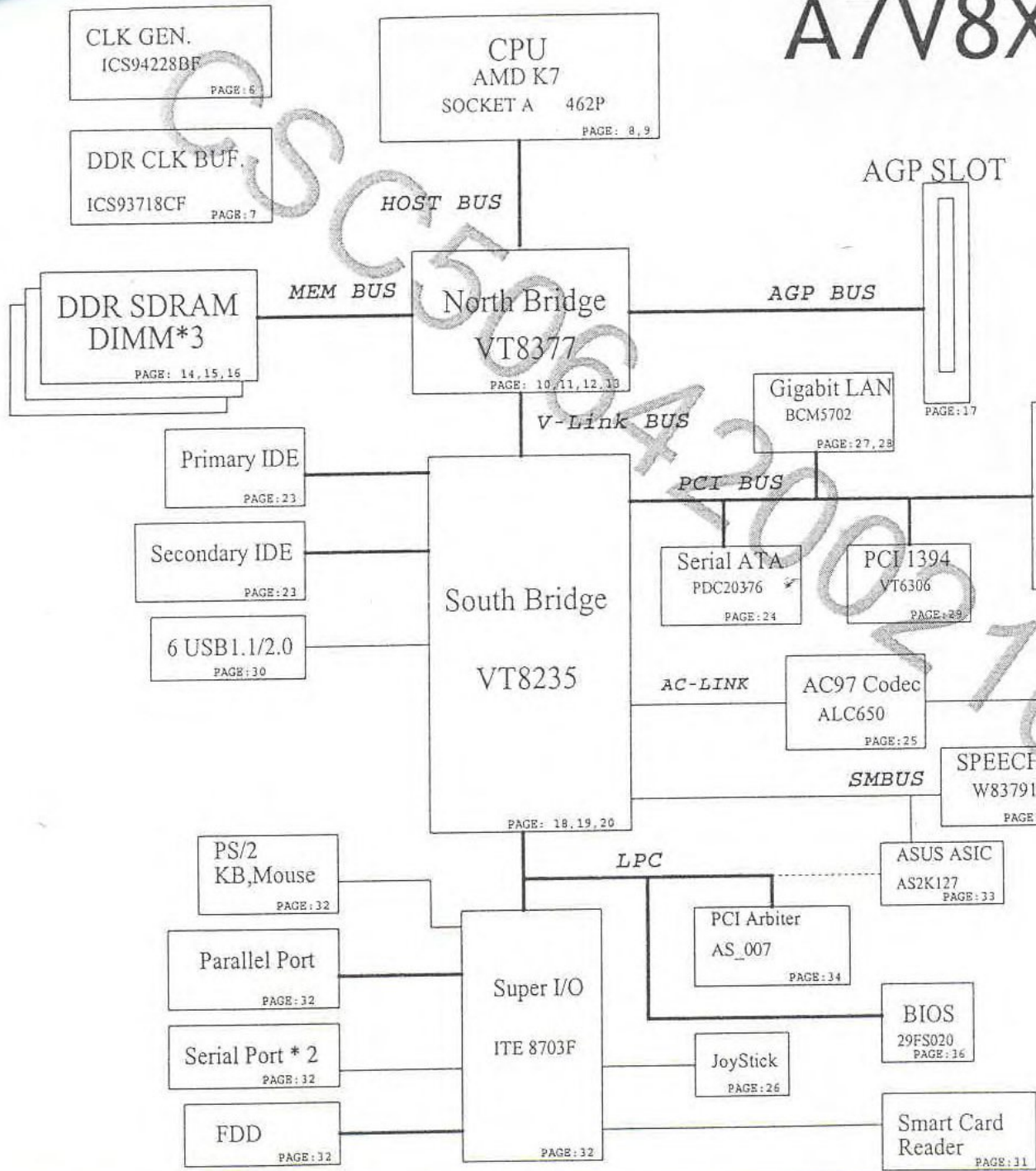

研發中心 客戶中心 發文
OCT 29 2002

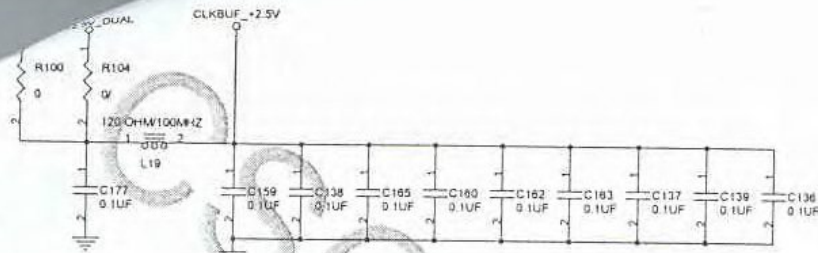

CLOCK Buffer

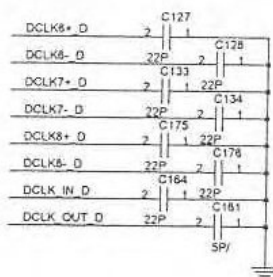
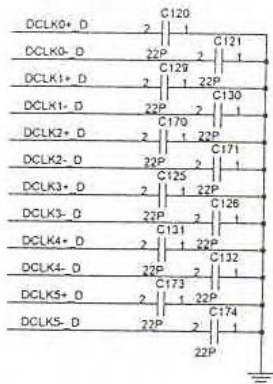
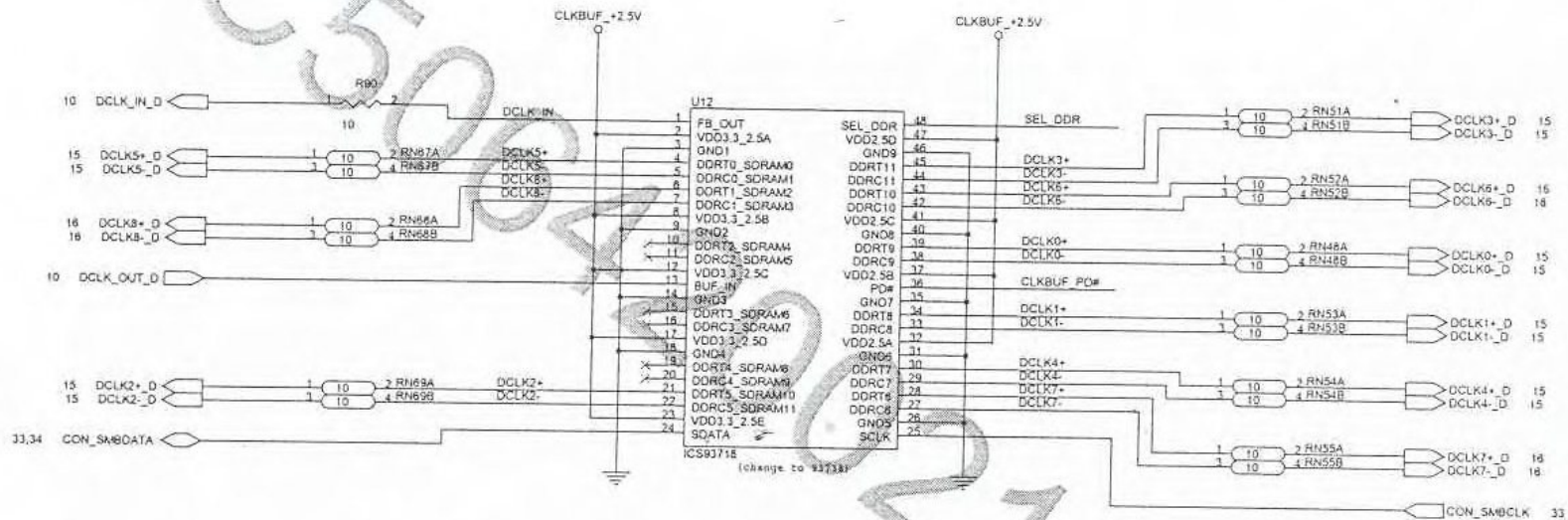

3506

20021028

104

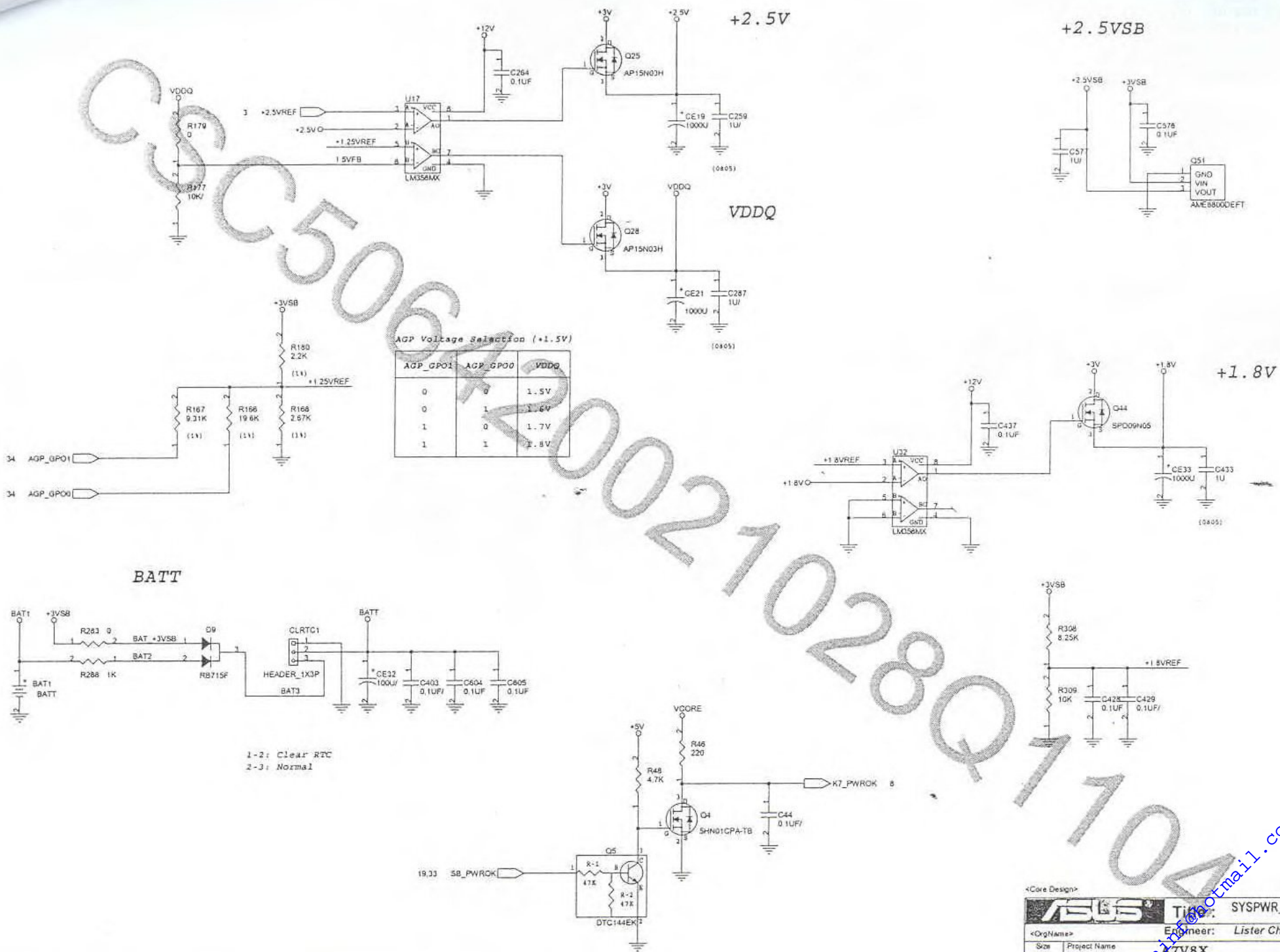

AGP Voltage Selection (+1.5V)

AGP_GPO1	AGP_GPO0	VDDQ
0	0	1.5V
0	1	1.6V
1	0	1.7V
1	1	1.8V

BATT

1-2: Clear RTC
2-3: Normal

<Core Design>

ASUS TITAN SYSPOWER_2

<OrigName> Engineer: Lister Chiou

Size	Project Name	Rev
A3	ATV8X	0.1

Date: 2002/08/17, 2002 Sheet 4 of 38

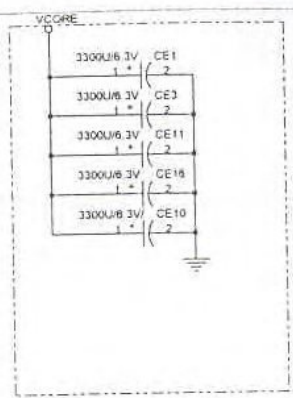
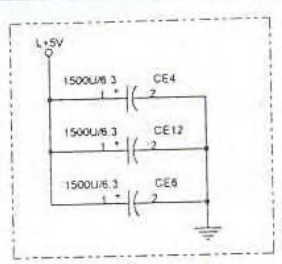
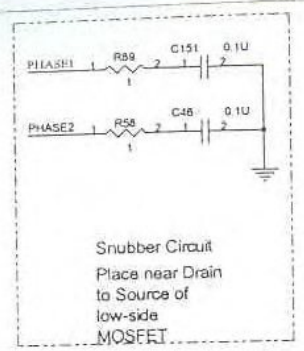

Hside MOSFET
1st: PHB96NQ03LT
2nd: IPB05N03L

Lside MOSFET
1st: PHB96NQ03LT
2nd: IPB05N03L

Output Choke
1st: 09-041162011
1.6uH/30A,TRIO
2nd: 09-041162015
1.6uH/30A,EMC

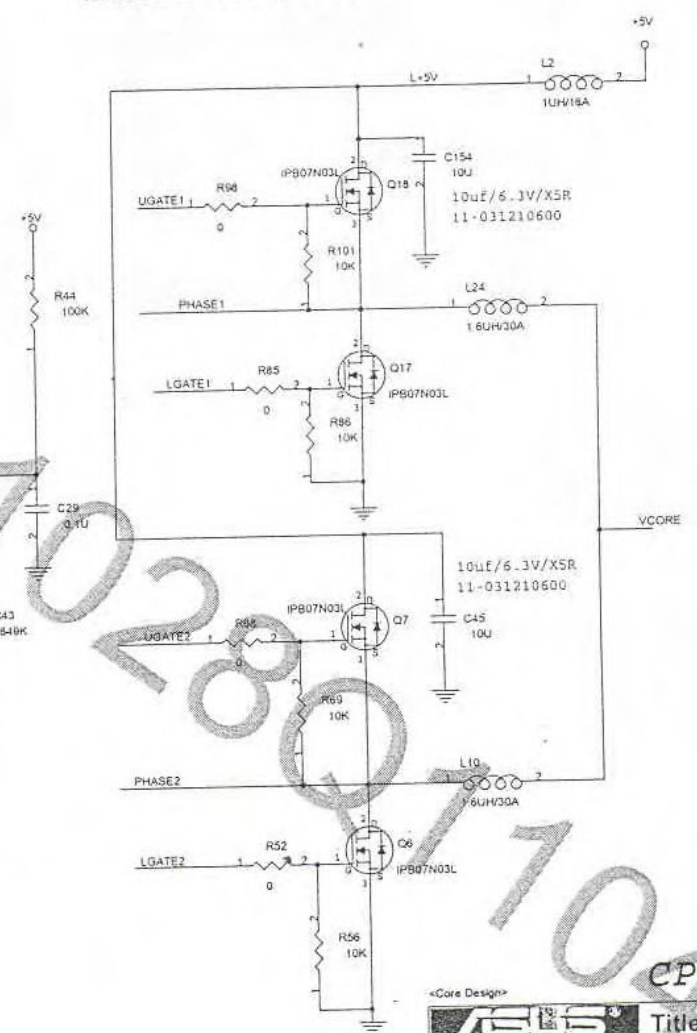
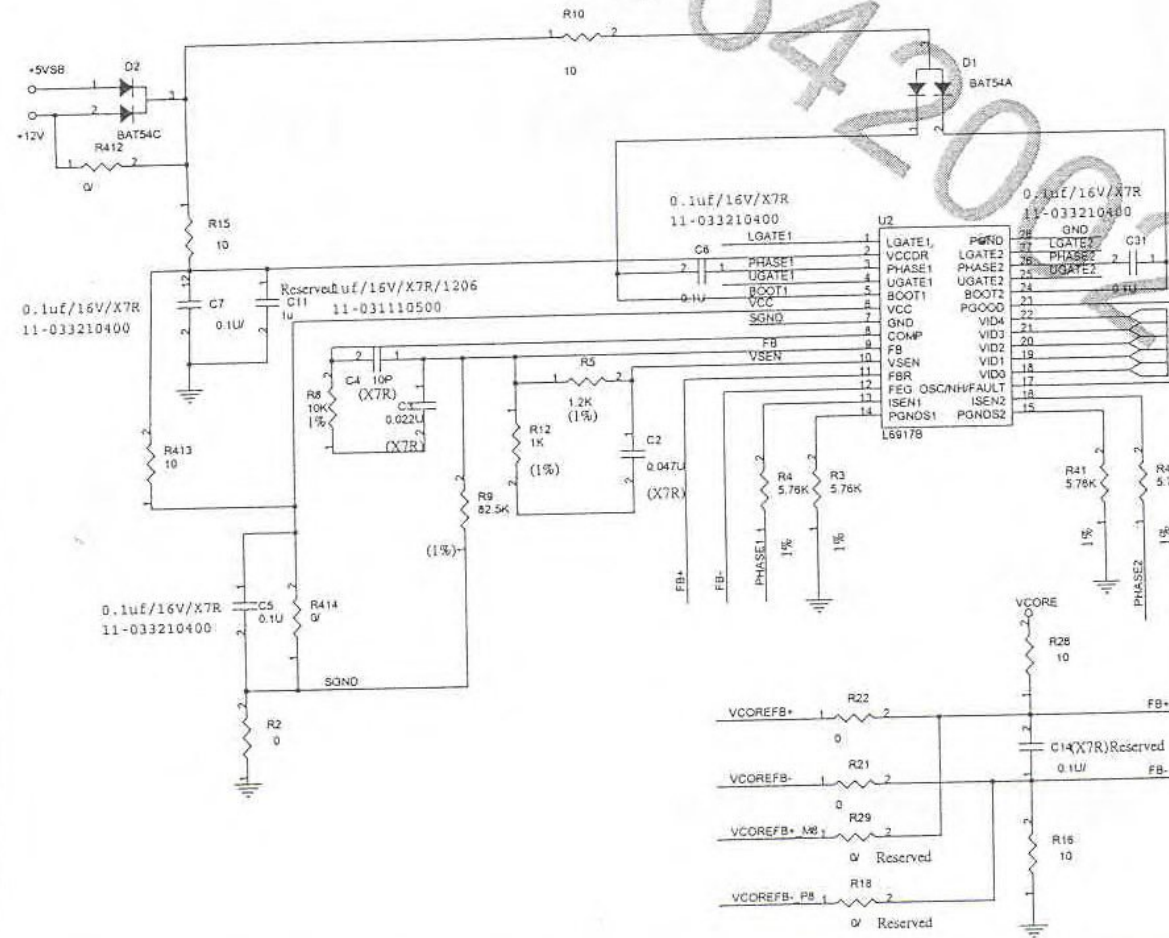
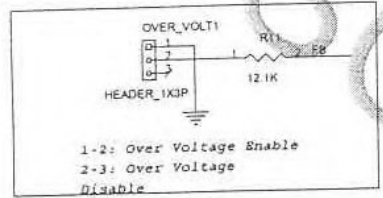

CPU DC/DC

ASUS		Title: CPU PWR	
Engineer: Lister Chiu		Rev: 0.1	
Size: A3	Project Name: ATX	Date: 2007.11.17	Sheet: 5 of 38

hexa.info@notmail.com

CLOCK Generator

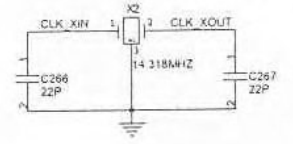
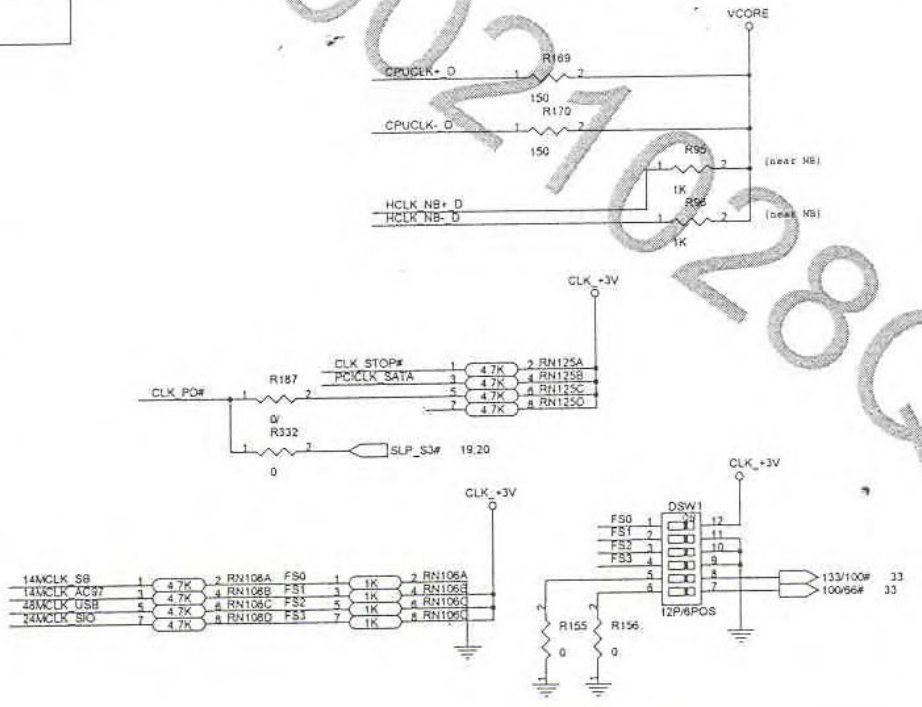
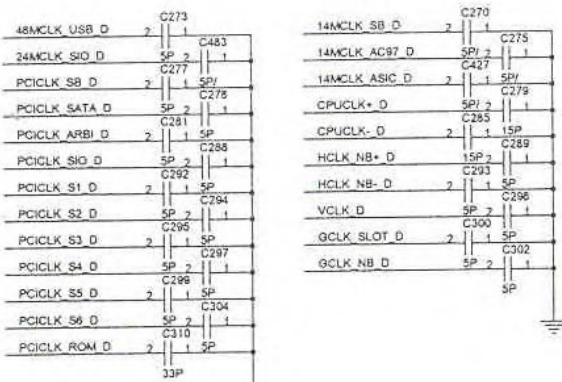
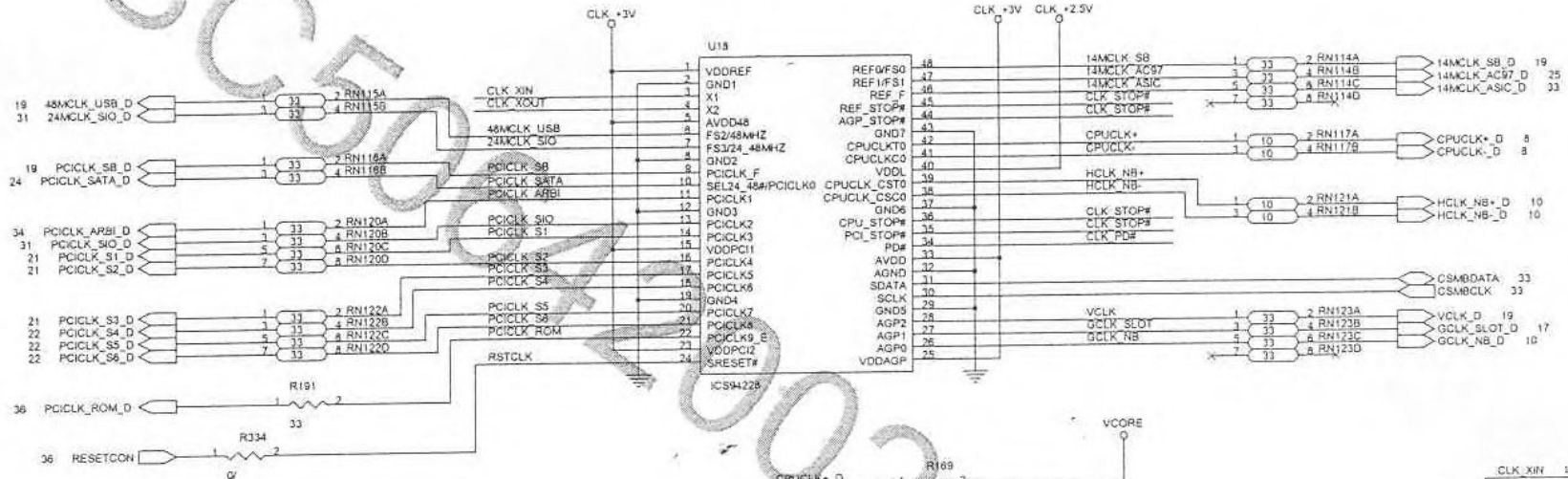
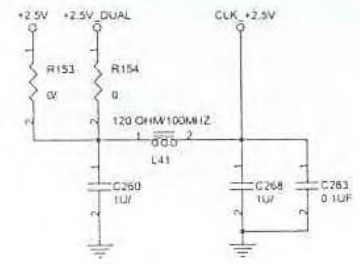
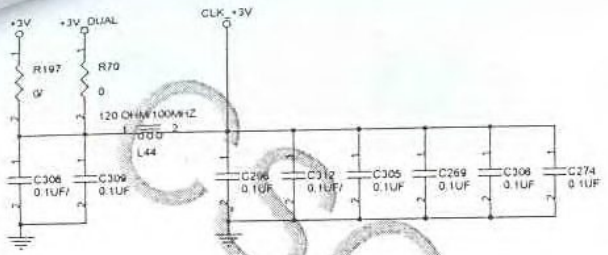

Frequency table for ICS94228

FS1	FS2	FS3	FS0	CPU	AGP	PCI
0	0	0	0	233.33	77.78	33.33
0	0	0	1	220	73.33	36.67
0	0	1	0	210	70	35
0	0	1	1	205	68.87	33.33
0	1	0	0	150	76	34
0	1	0	1	180	72	35
0	1	1	0	170	68	34
0	1	1	1	150	75	37.5
1	0	0	0	140	70	35
1	0	0	1	120	60	30
1	0	1	0	110	66	33
1	0	1	1	66.67	66.67	33.33
1	1	0	0	200	66.67	33.33
1	1	0	1	166.67	66.67	33.33
1	1	1	0	100	66.67	33.33
1	1	1	1	133.33	66.67	33.33

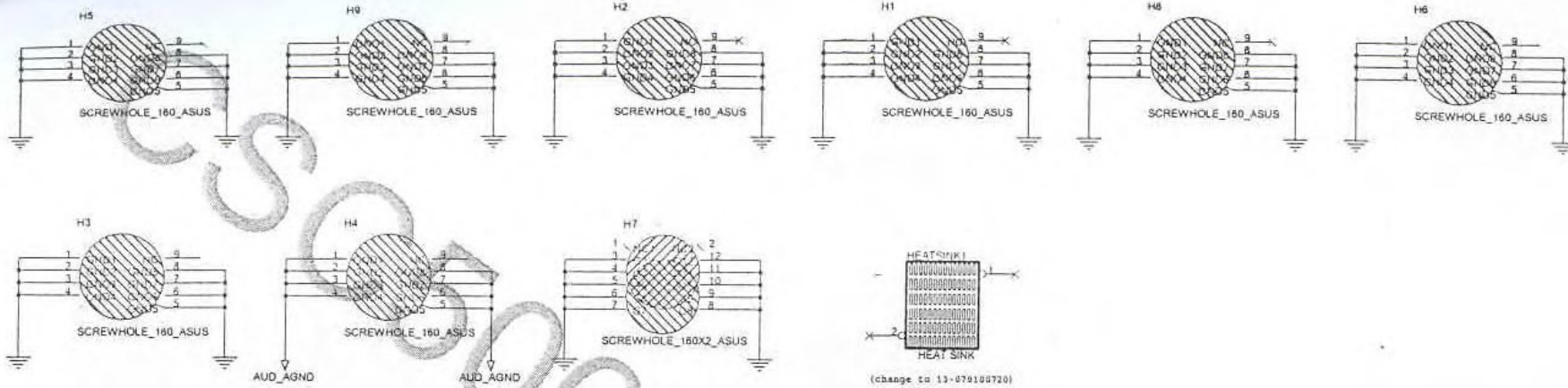

EMI

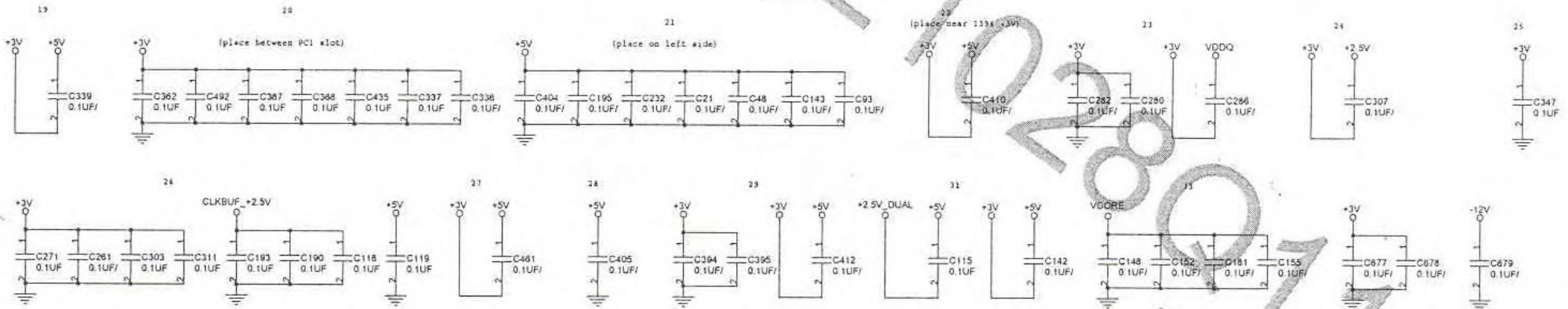

SPEECH

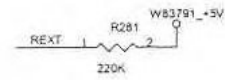
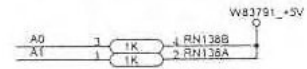
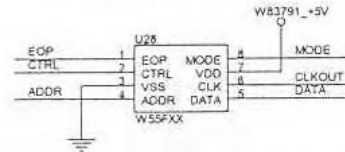
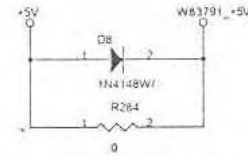
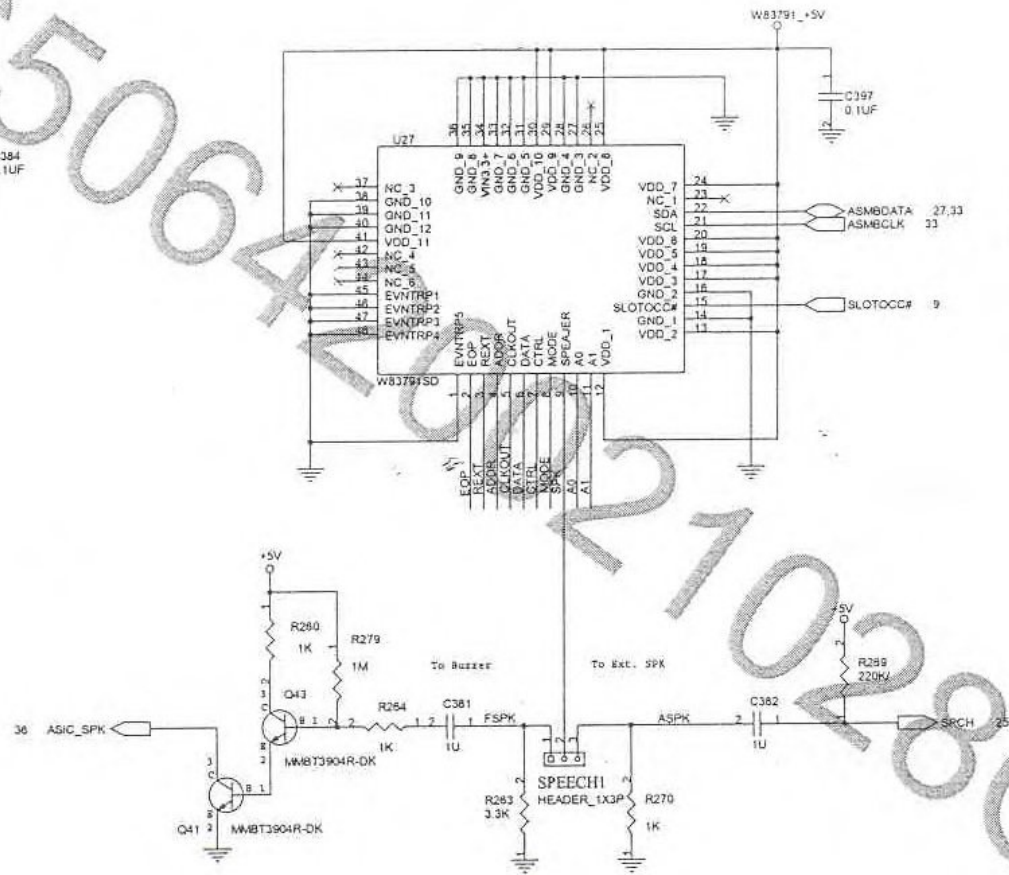
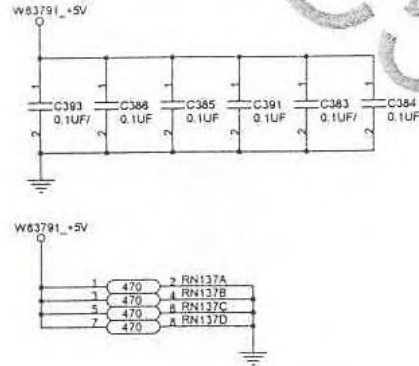

ASUS		Title: SPEECH	
Engineer: Zister Chiou		Date: 2002.11.17	
Size: A3	Project Name: A7V8X	Rev: 0.1	Sheet: 17 of 38

SK7VID0_4
K7VID0_4

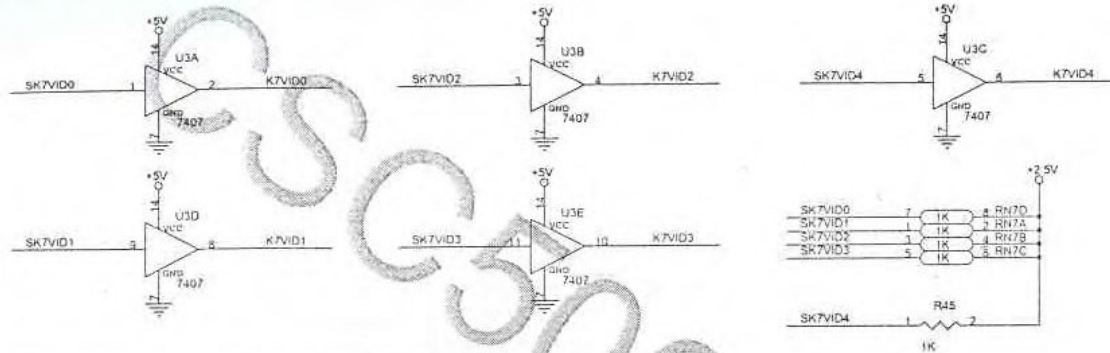

VID4	JUMPER	MODE	VID3	VID1	VCCORR
1-2	1-2	1-2	1-2	1-2	1.450V/1.425V
1-2	1-2	1-2	2-3	2-3	1.400V/1.375V
1-2	1-2	2-3	1-2	1-2	1.750V/1.725V
1-2	1-2	2-3	2-3	2-3	1.700V/1.675V
1-2	2-3	1-2	1-2	1-2	1.450V/1.425V
1-2	2-3	1-2	2-3	2-3	1.400V/1.375V
1-2	2-3	2-3	1-2	1-2	1.550V/1.525V
1-2	2-3	2-3	2-3	2-3	1.500V/1.475V
2-3	1-2	1-2	1-2	1-2	1.450V/1.425V
2-3	1-2	1-2	2-3	2-3	1.400V/1.375V
2-3	1-2	2-3	1-2	1-2	1.750V/1.725V
2-3	1-2	2-3	2-3	2-3	1.700V/1.675V
2-3	2-3	1-2	1-2	1-2	1.250V/1.225V
2-3	2-3	1-2	2-3	2-3	1.200V/1.175V
2-3	2-3	2-3	1-2	1-2	1.550V/1.525V
2-3	2-3	2-3	2-3	2-3	1.500V/1.475V OR JUMPERLESS

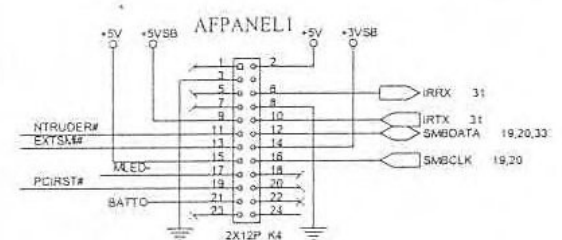
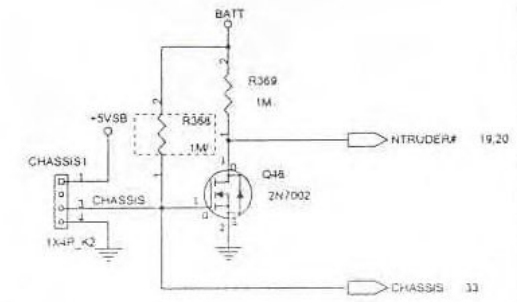

LPC BIOS

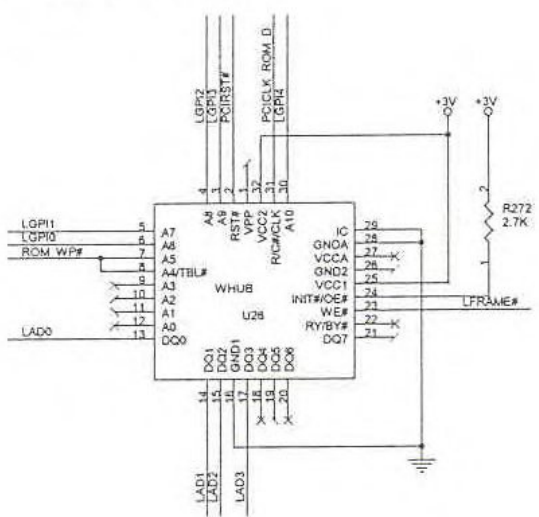
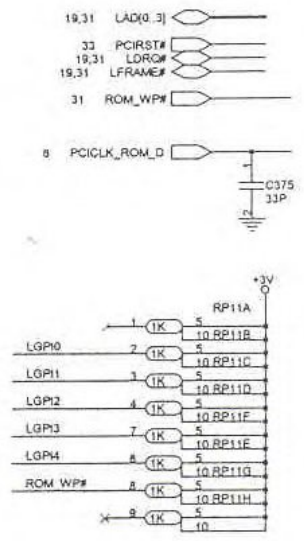

PANEL

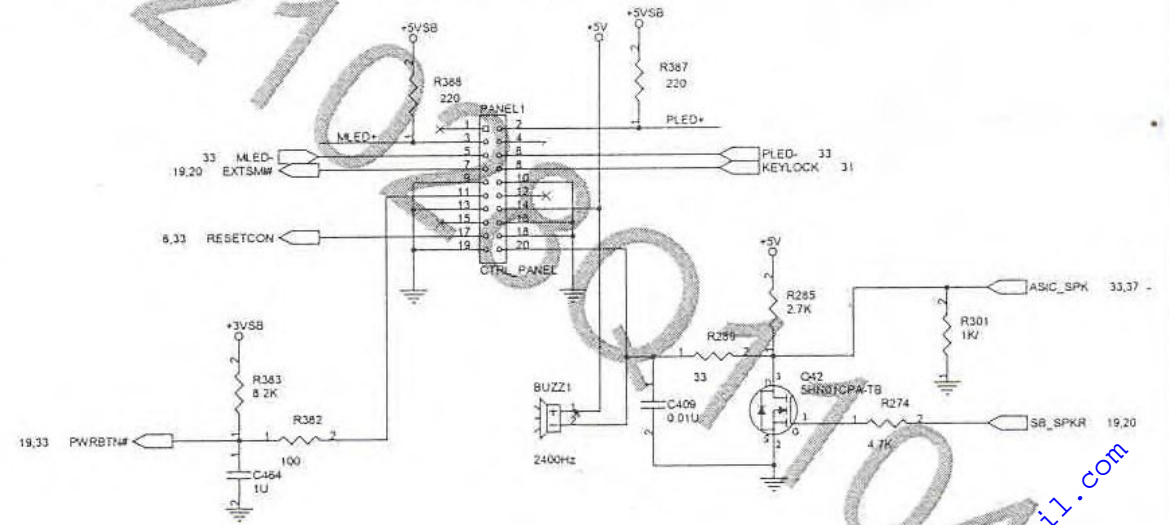

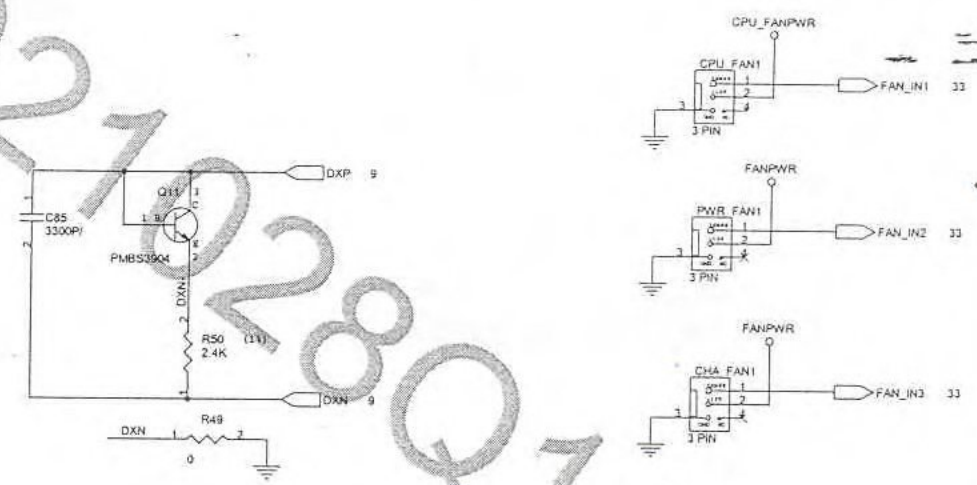
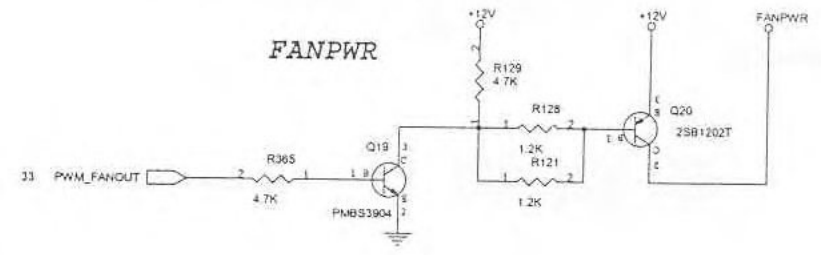
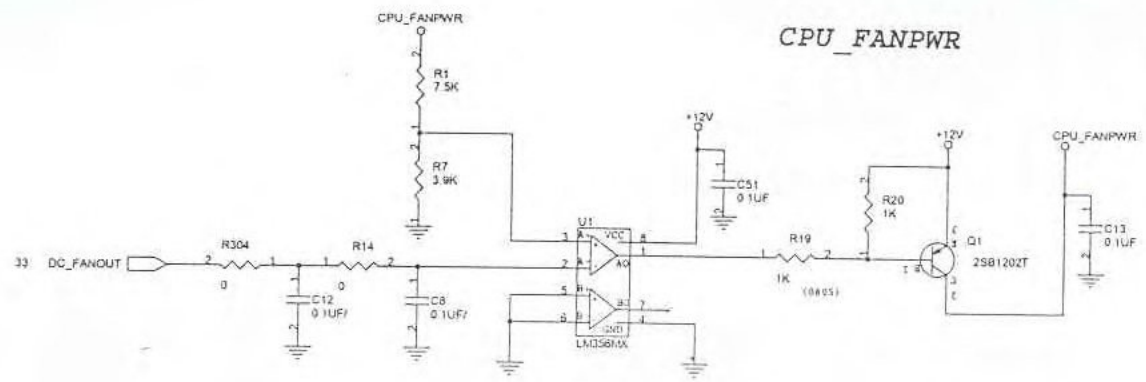
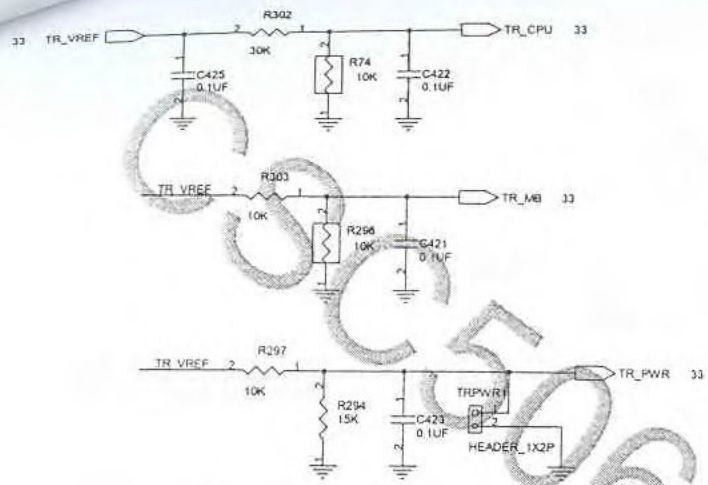

<Core Design>

ASUS		Type:	FAN
<OrgName>		Engineer:	Lister Chiou
Size	A3	Project Name	47V8X
			Rev
			0.1

6 FIDIN0_3
19 SA[16..19]
9 FIDCPU0_4

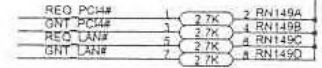
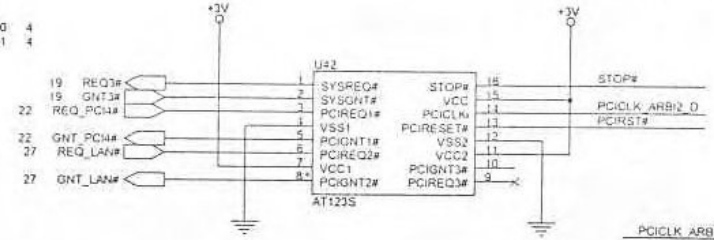
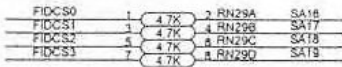
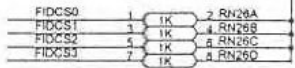
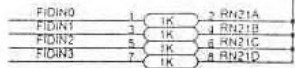
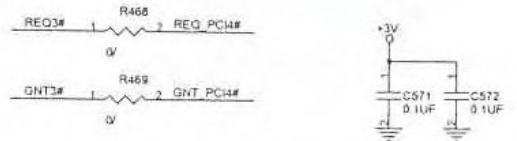

PCI Arbiter & Clock Buffer

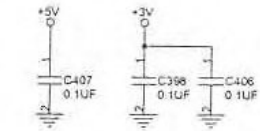
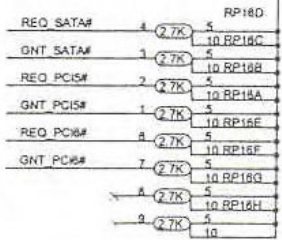
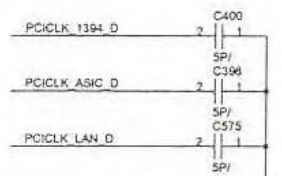
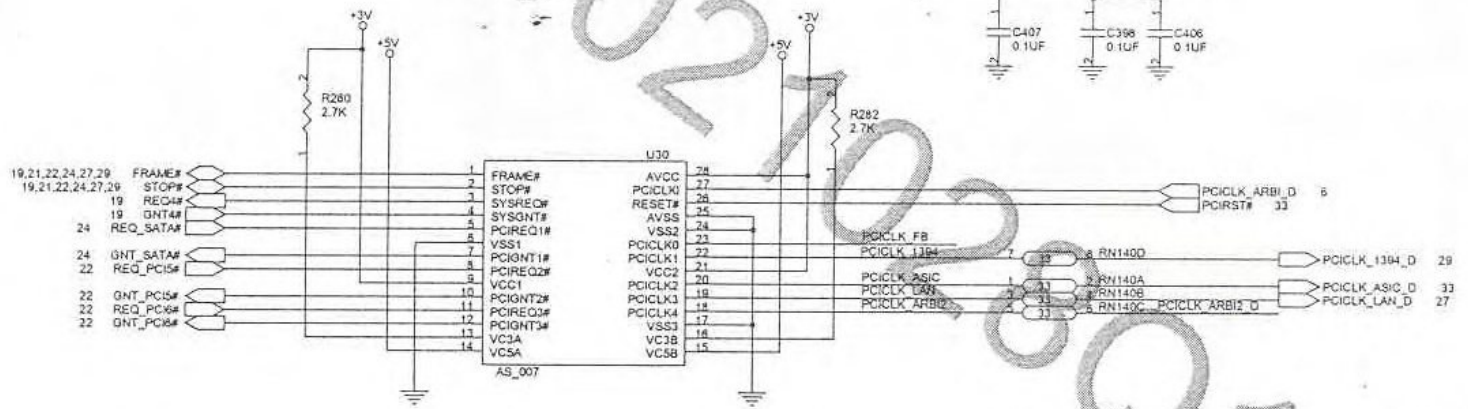

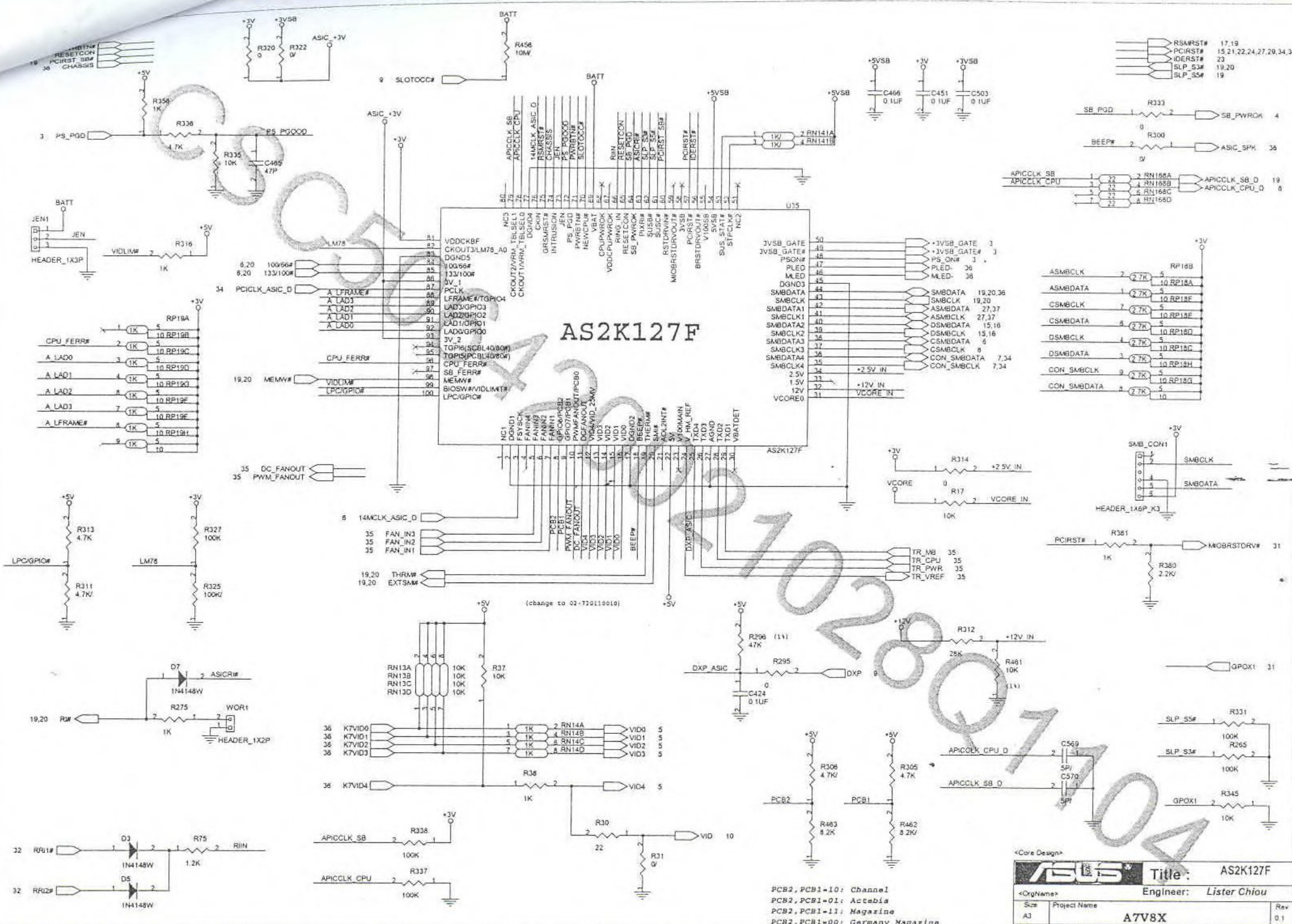

AS2K127F

<Core Design>

ASUS Title: AS2K127F

<OrigName> Engineer: Lister Chiou

Size	Project Name	Rev
A3	A7V8X	0.1

Date: 1/19/2002 Sheet 33 of 38

PCB2, PCB1=10: Channel
 PCB2, PCB1=01: Actebis
 PCB2, PCB1=11: Magazine
 PCB2, PCB1=00: Germany Magazine

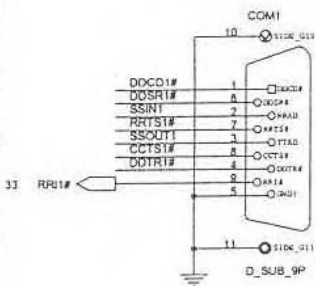
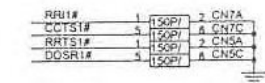
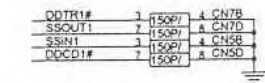
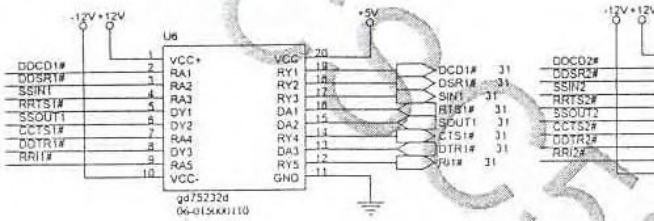

COM1/2

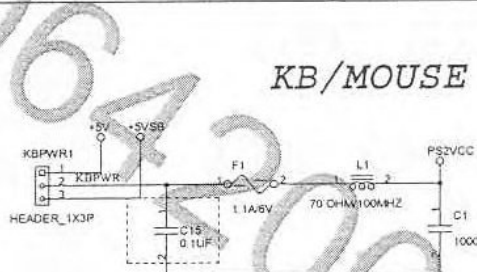

KB/MOUSE

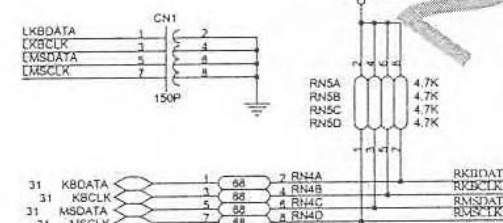

FDD

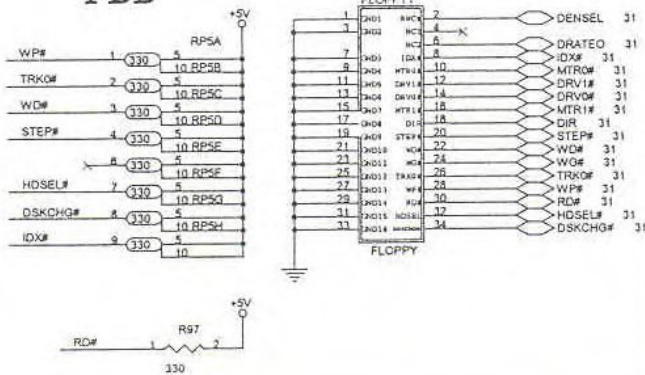

Parallel Port

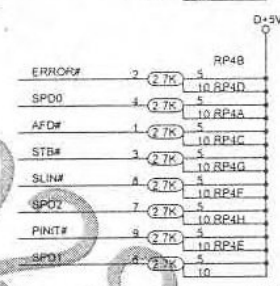
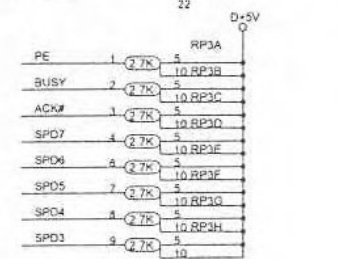
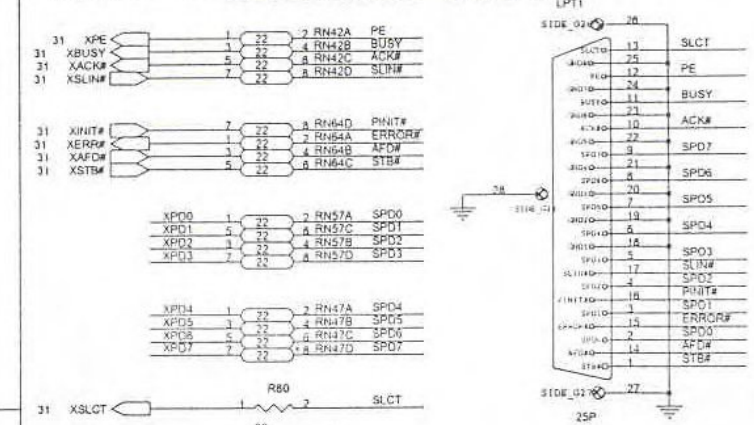

IR

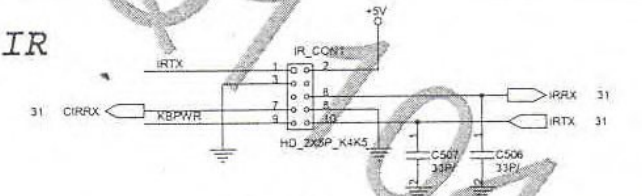

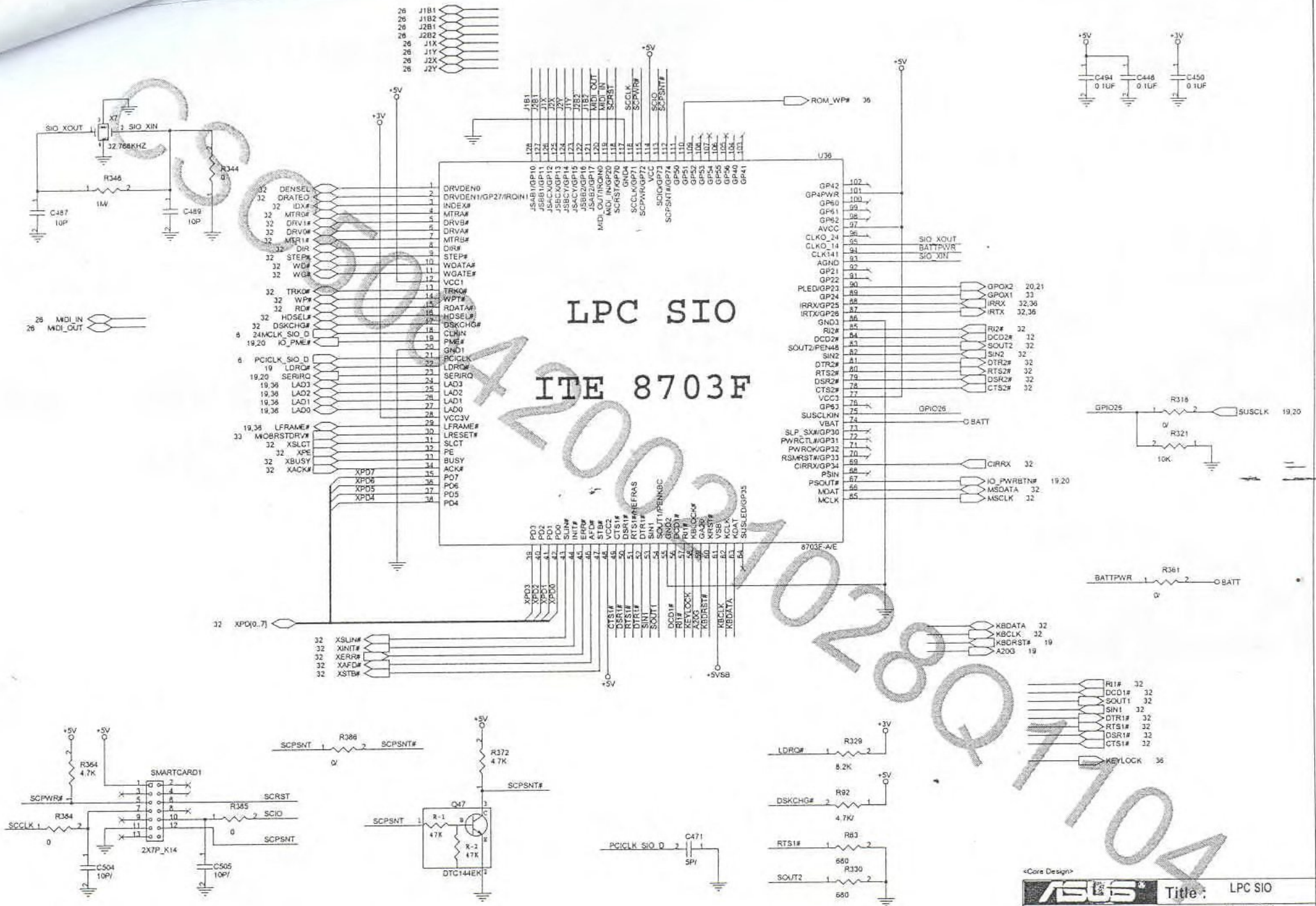

LPC SIO ITE 8703F

<Core Design>

ASUS		Title:	LPC SIO
<OrigName>	Engineer:	Lister Chiou	
Size	Project Name	A7V8X	
Date: 2002.08.17	Rev	0.1	
Sheet		31 of 38	

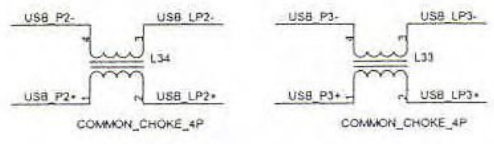
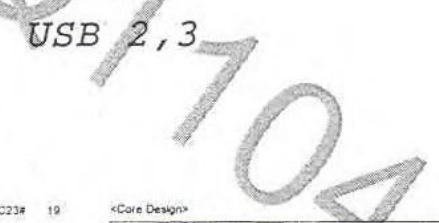
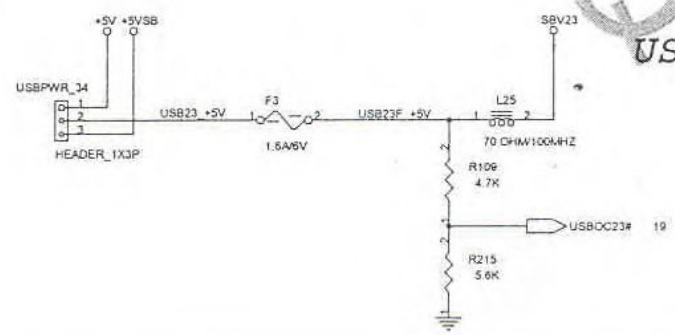
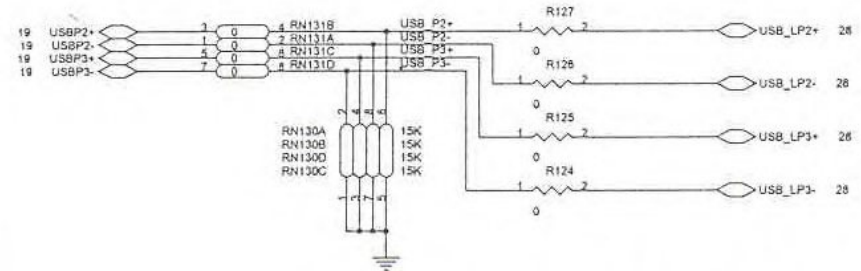
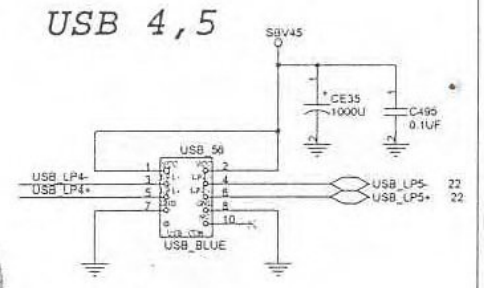
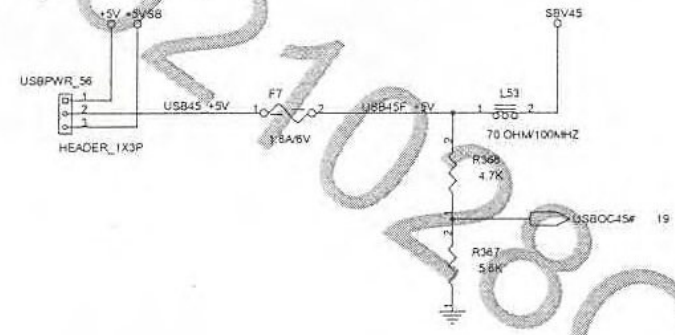
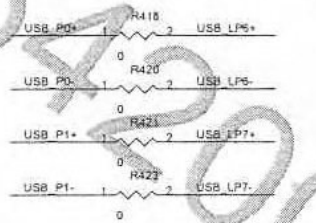
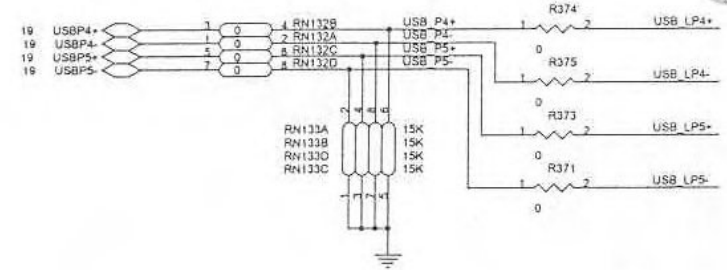
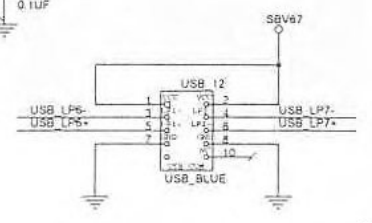
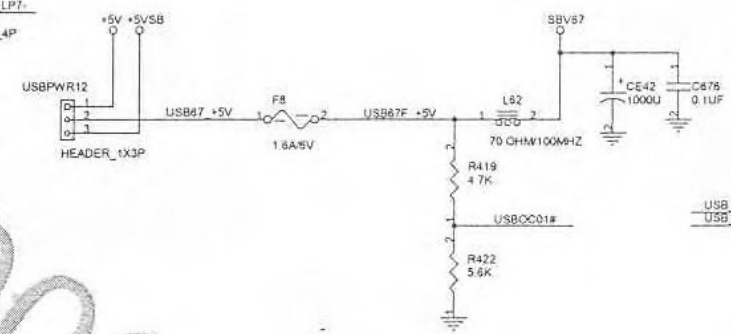
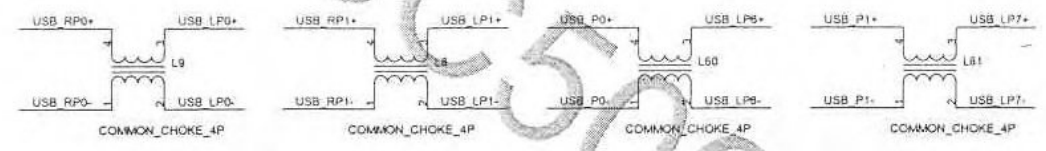
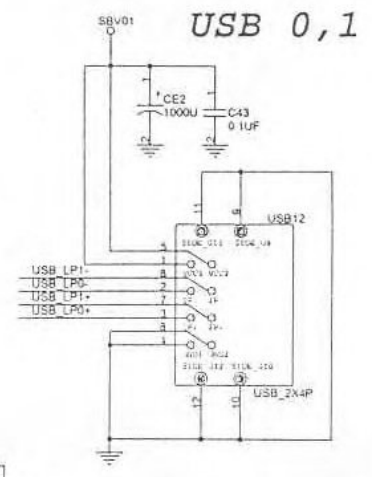
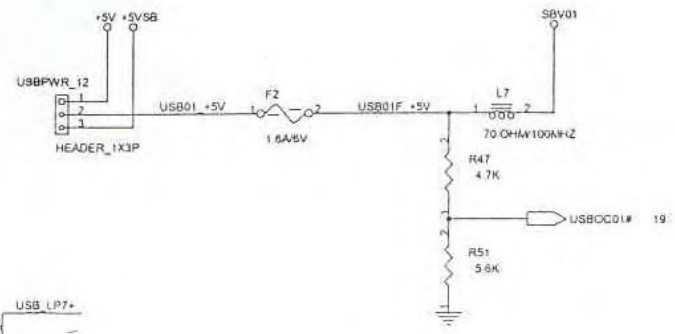
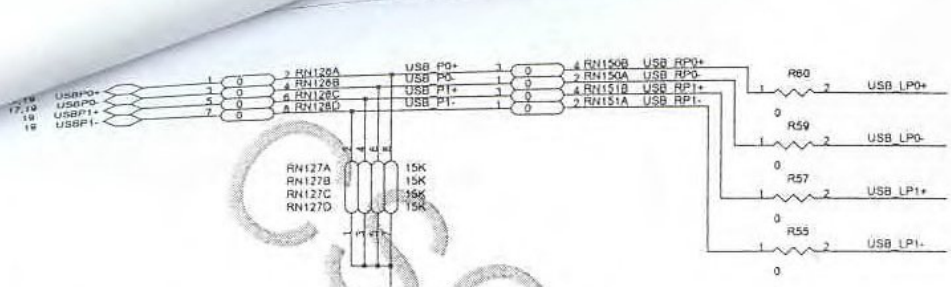

Title: USB PORT	
Engineer: Lister Chiu	
Project Name: A7V8X	Rev: 0.1
Date: 8/17/2002	Sheet: 30 of 38

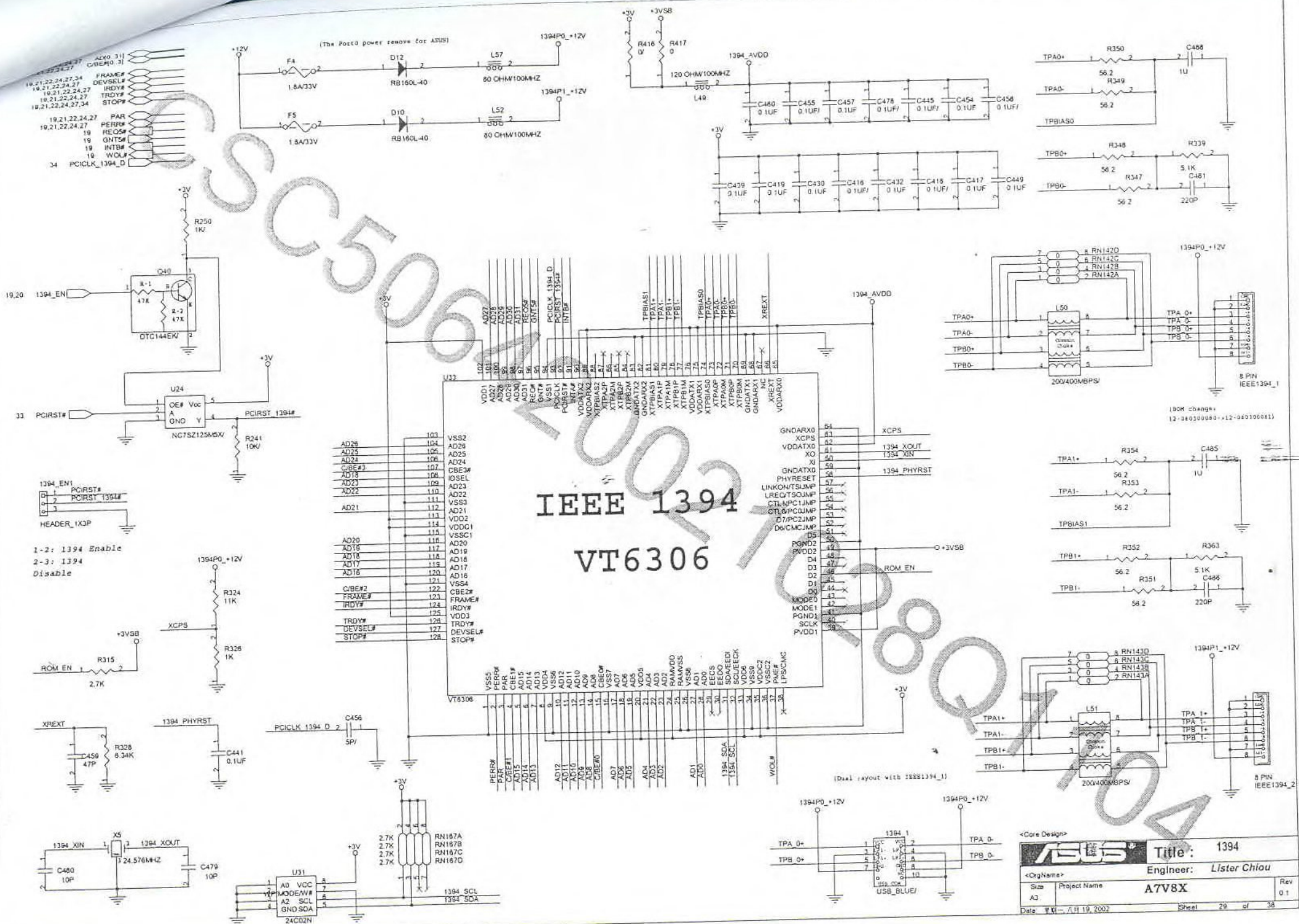

**IEEE 1394
VT6306**

1-2: 1394 Enable
2-3: 1394 Disable

[Dual layout with IEEE1394_1]

<Core Design>

ASUS		Title:	1394
Engineer:		Lister Chiou	
Size	Project Name	A7V8X	Rev
AJ			0.1
Date	11/19/2002	Sheet	29 of 38

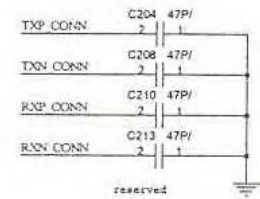
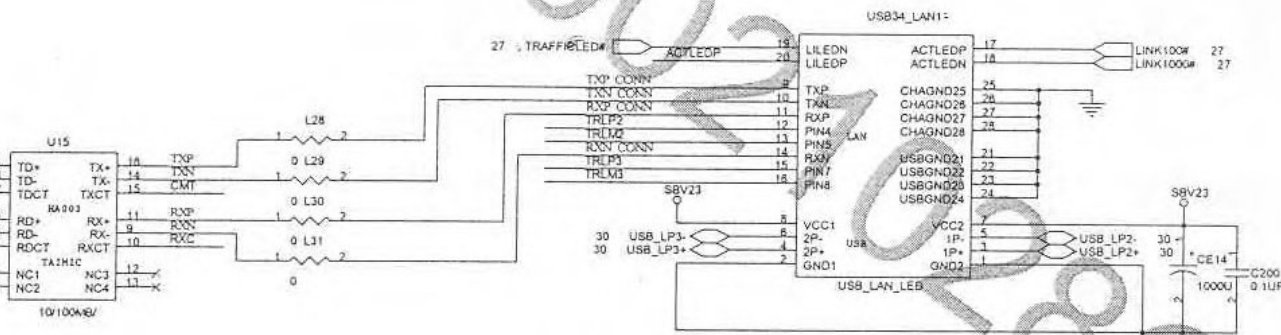
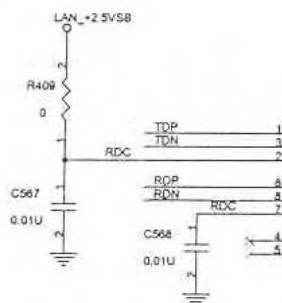
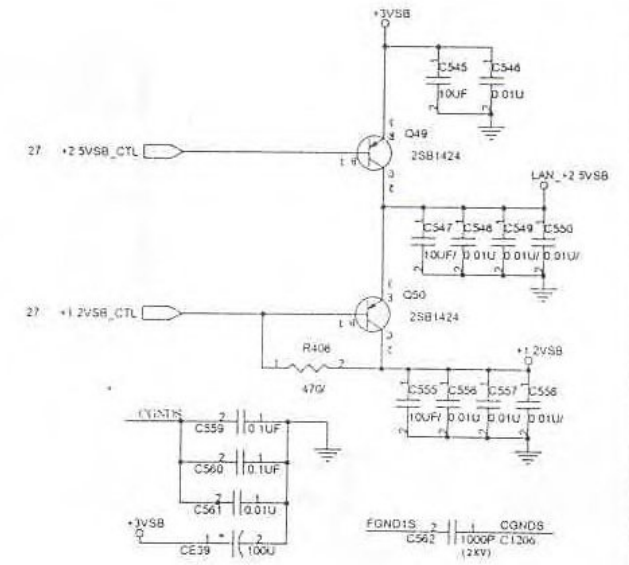
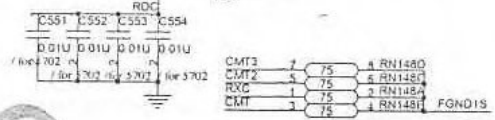
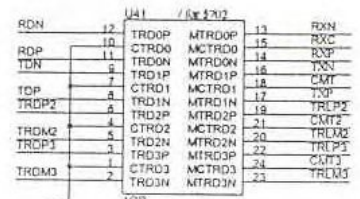
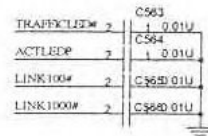
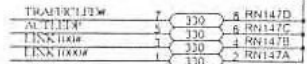
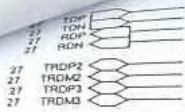

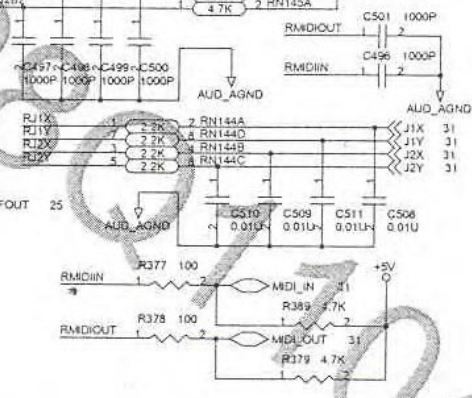
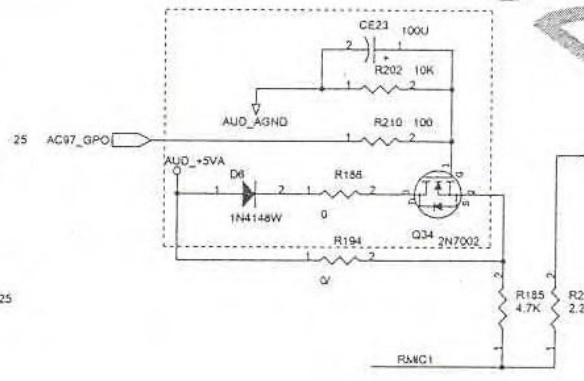
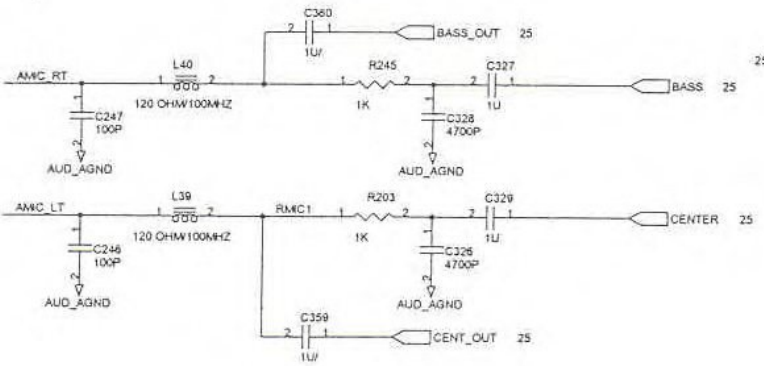
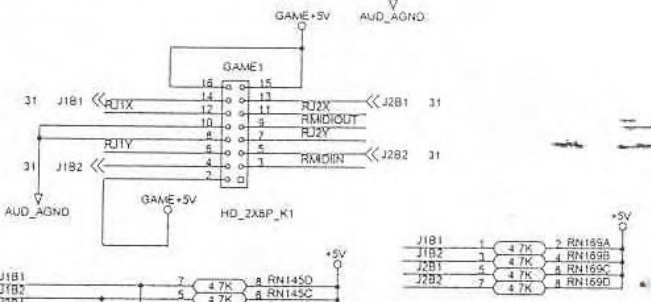
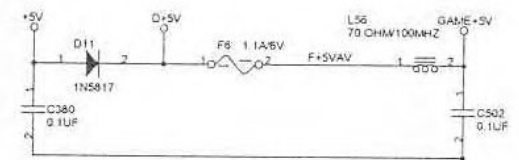
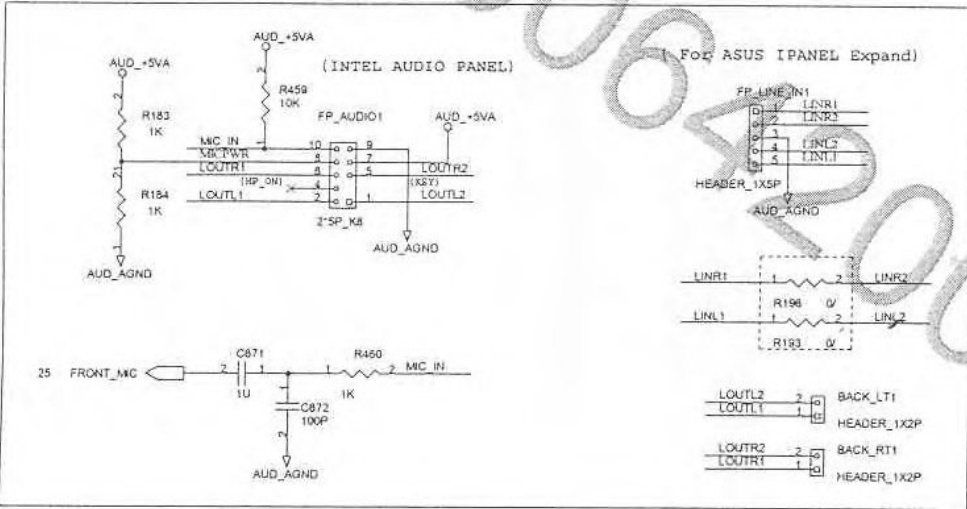
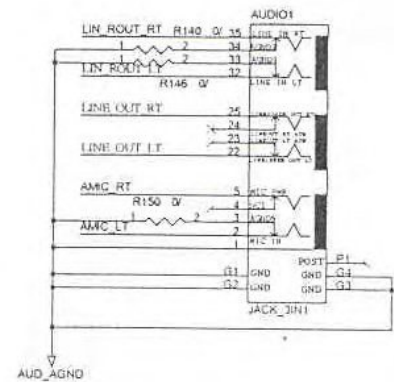
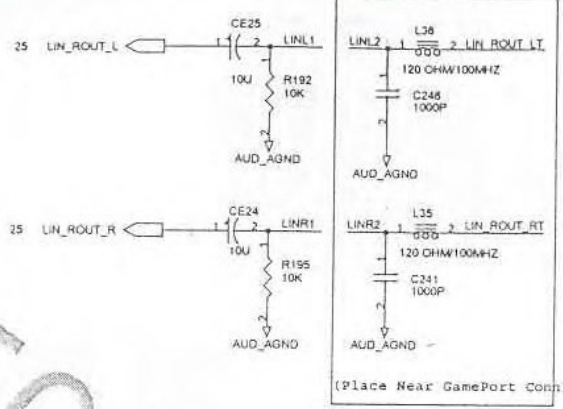
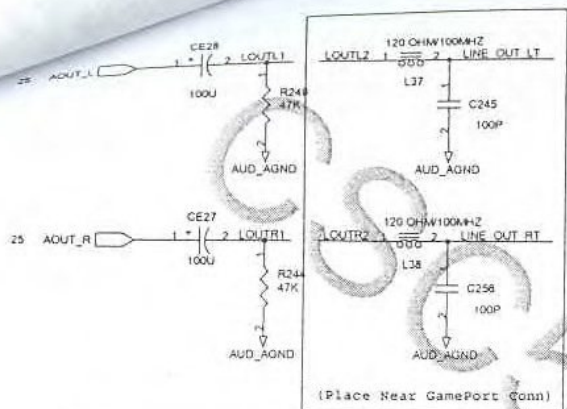

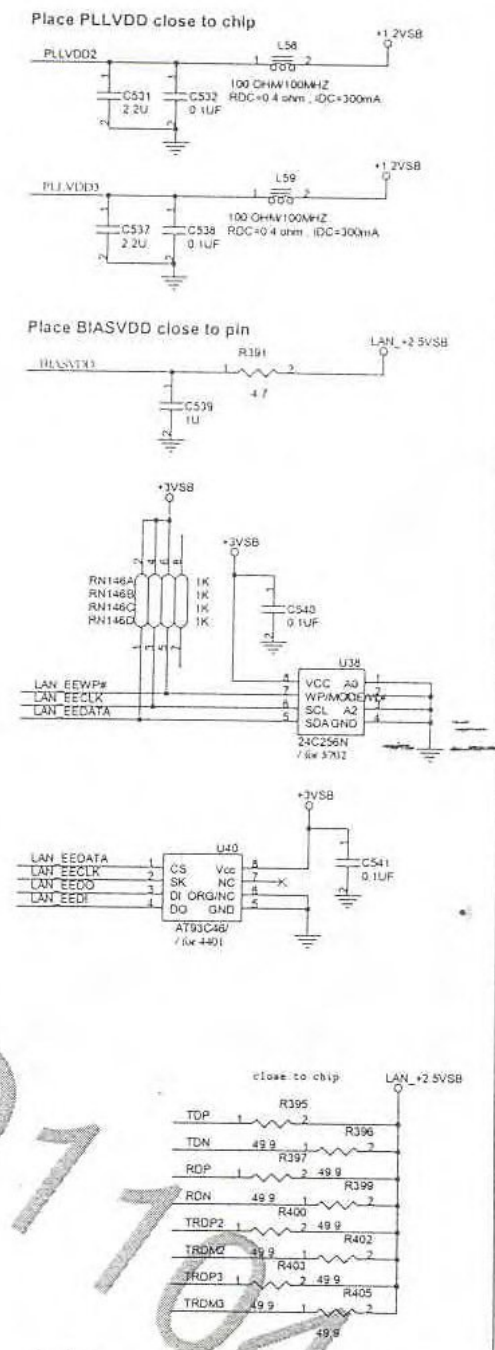
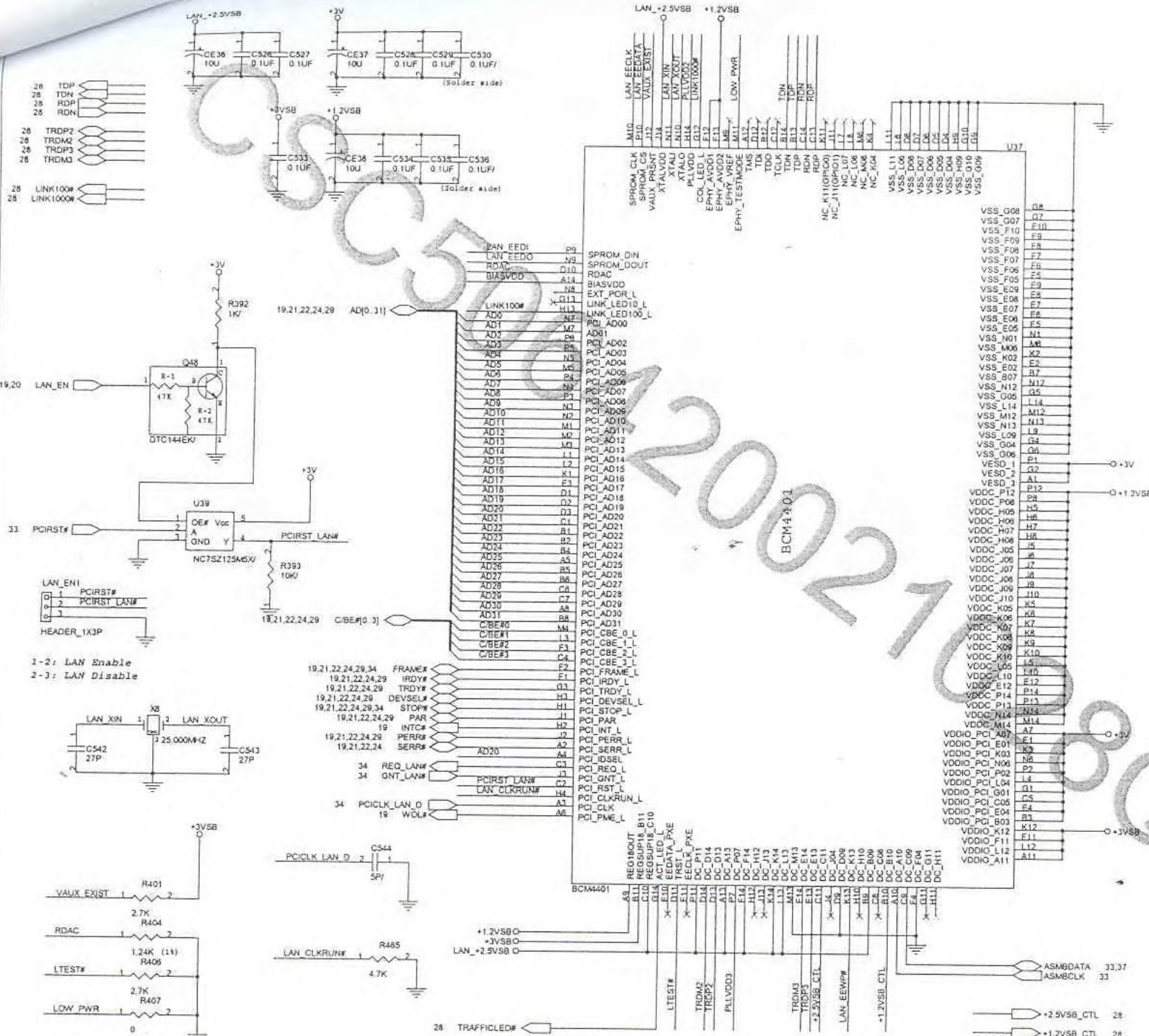

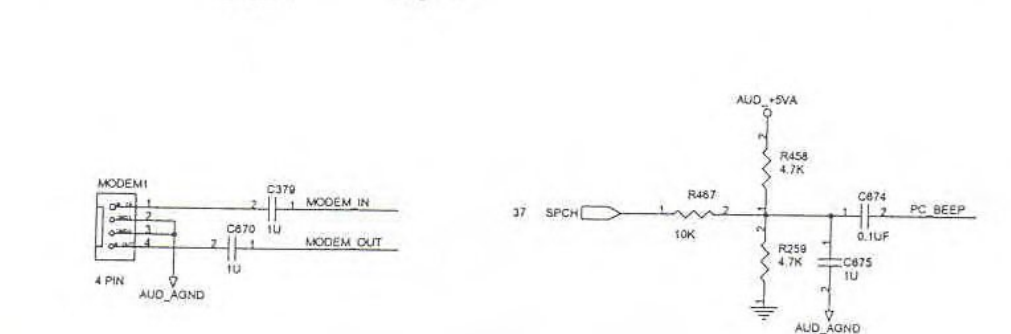
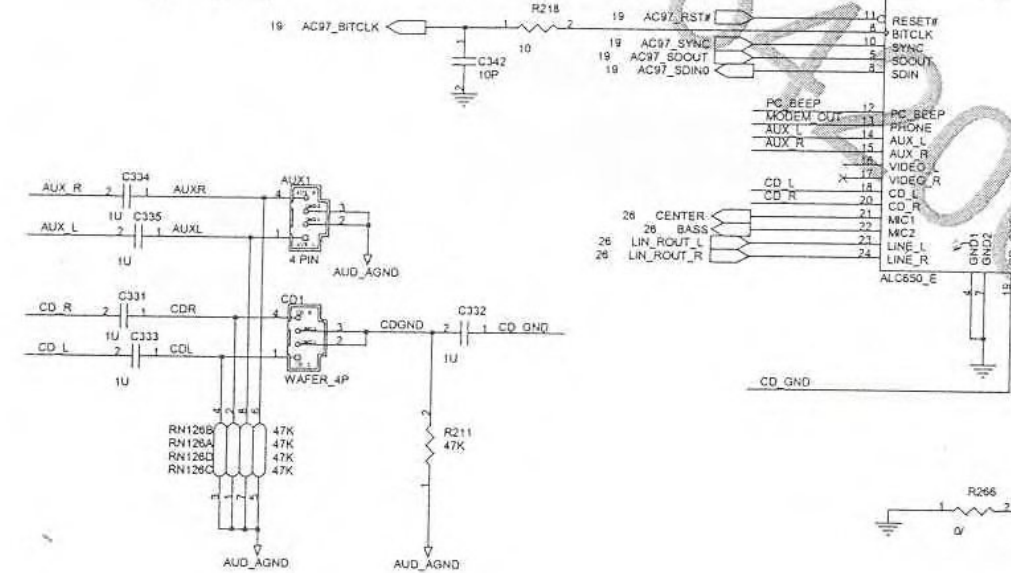
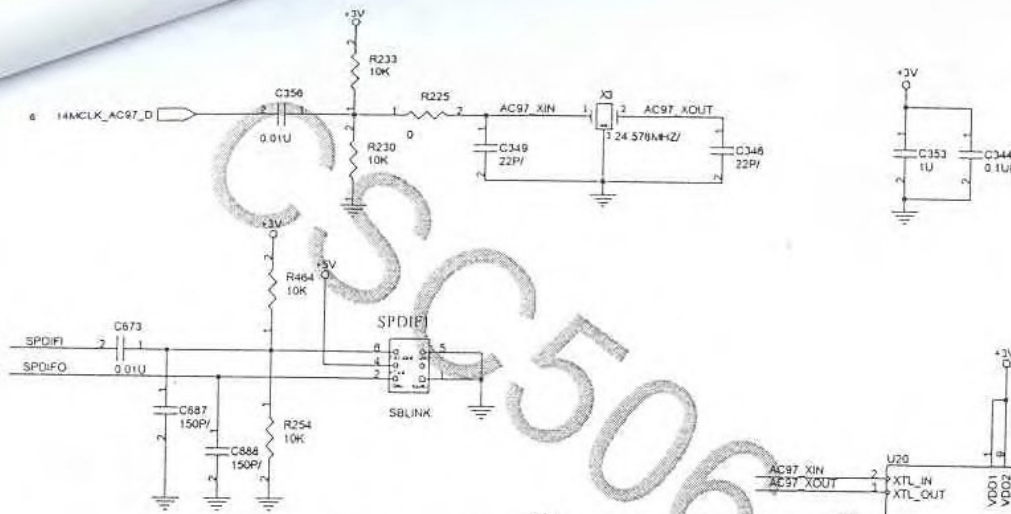

AC97 Codec

AUD_+5VA

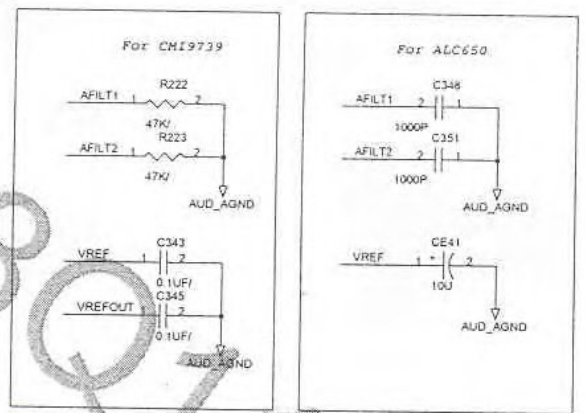
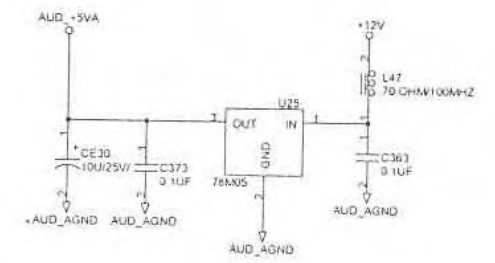

14.318MHz Clock input:
 For ALC650: XTSEL=0
 For CMI9739: XTSEL=0
 24.576MHz X'Tal
 For ALC650: XTSEL=NC
 For CMI9739: XTSEL=1

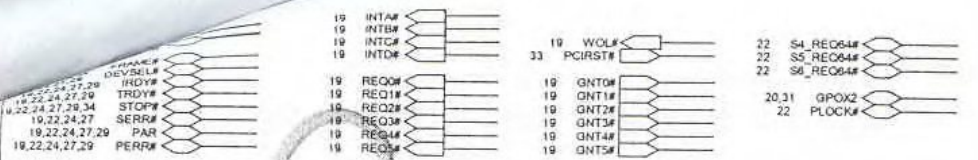

PCI SLOT1

PCI SLOT2

PCI SLOT3

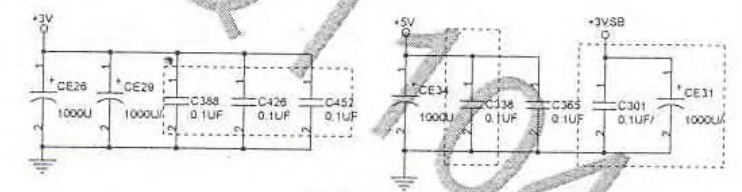
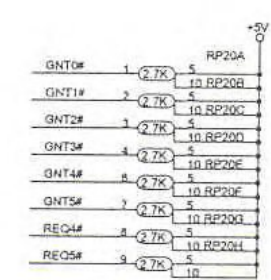
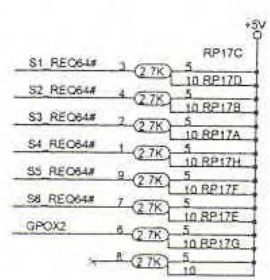
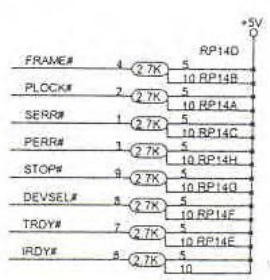
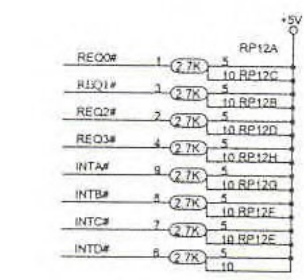
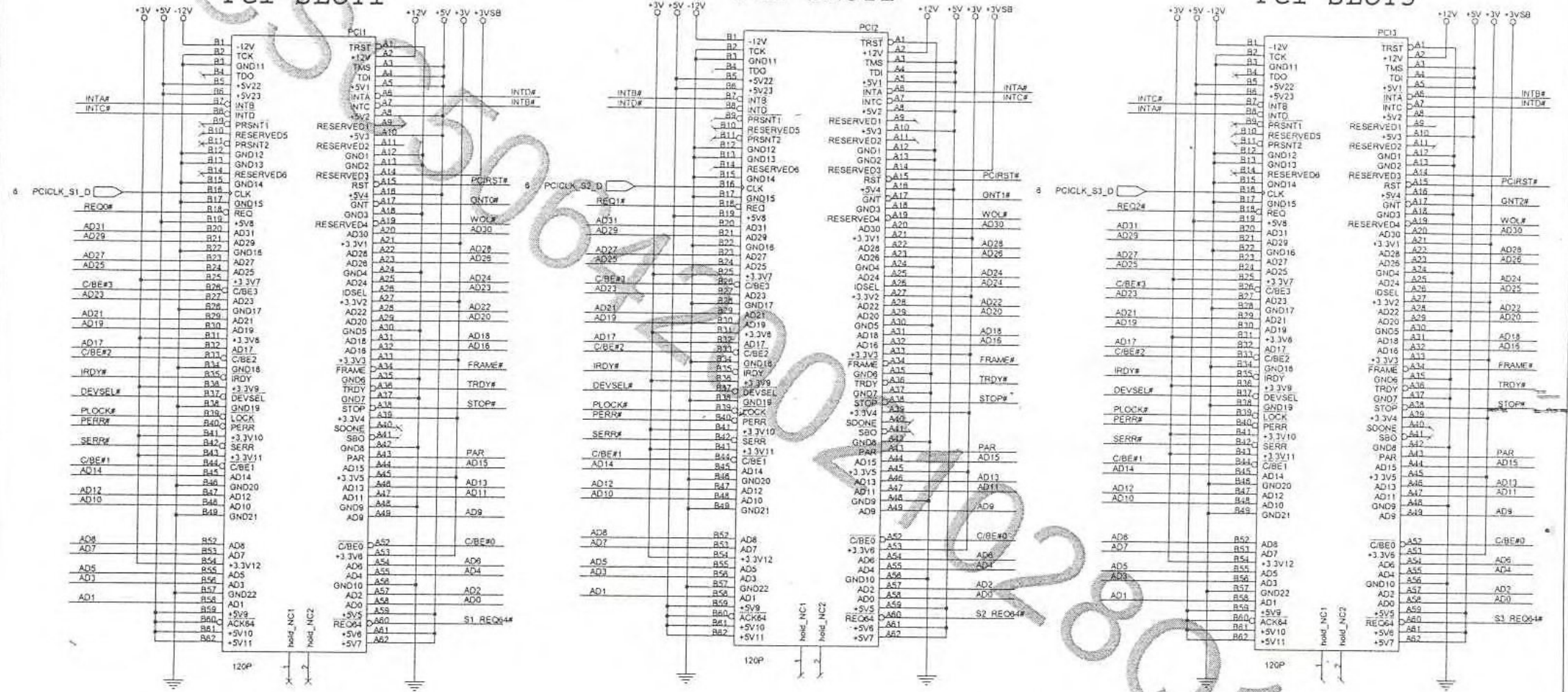

ASUS
Title: PCI SLOT_1
Engineer: Lister Chiou
A7V8X
Date: 2007.07.17
Sheet: 21 of 38

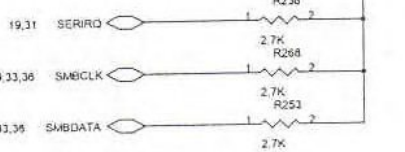
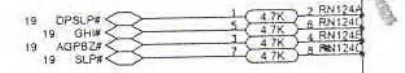
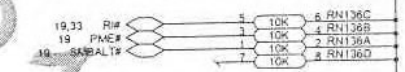
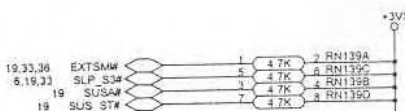
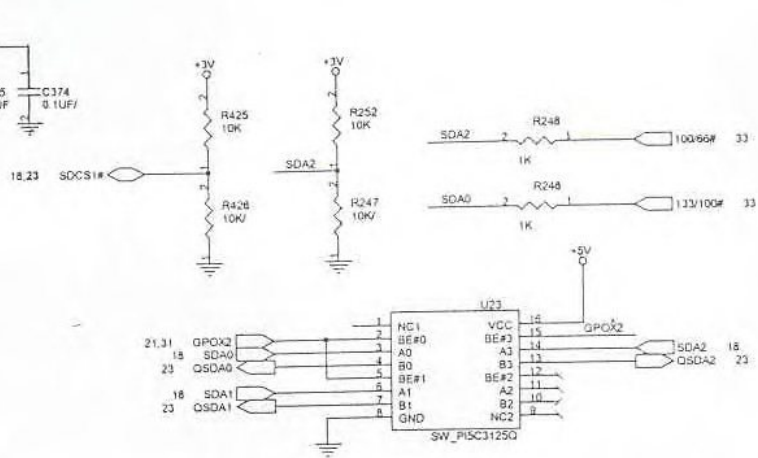
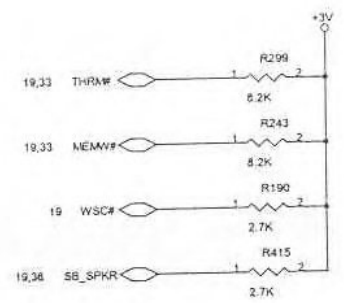
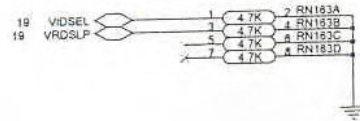
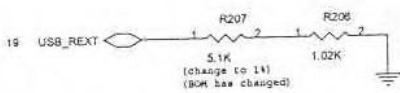
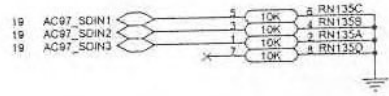
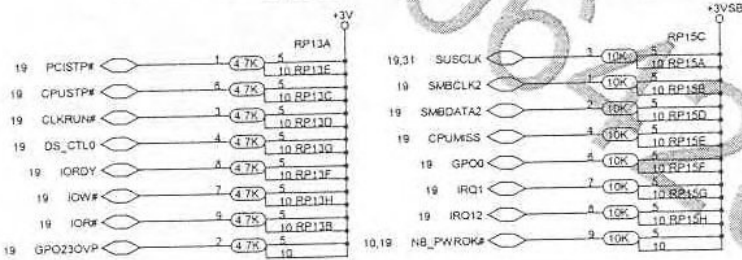
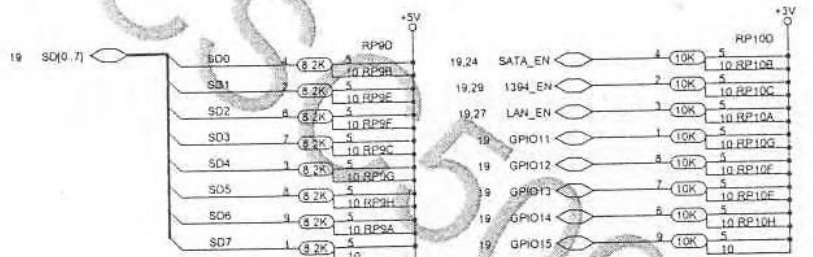
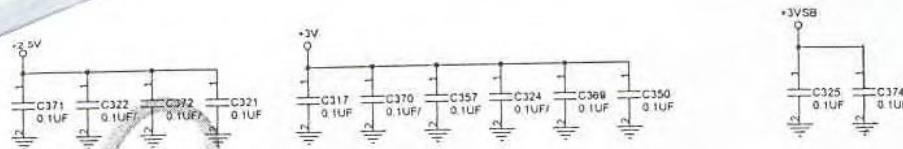

LVREF_SB

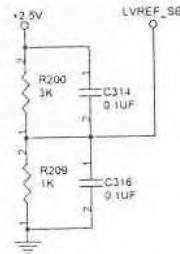

LVREF_SB = 0.625V

Power Up Strappings :

SA[19:14] => CPU Clock Divider			
0000	11	1000	7
0001	11.5	1001	7.5
0010	12	1010	8
0011	12.5	1011	8.5
0100	5	1100	9
0101	5.5	1101	9.5
0110	6	1110	10
0111	6.5	1111	10.5

Strapping Information Select

- 0 : From Hardware Strapping (DEFAULT)
- 1 : From Boot ROM

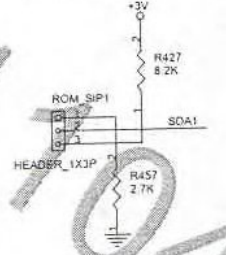

<Core Design>

ASUS Title: VT8235_3

<OrigName> Engineer: Lister Chiou

Size	Project Name	A7V8X	Rev
A3			0.1

Date: 2002.08.17 2002 Sheet 20 of 38

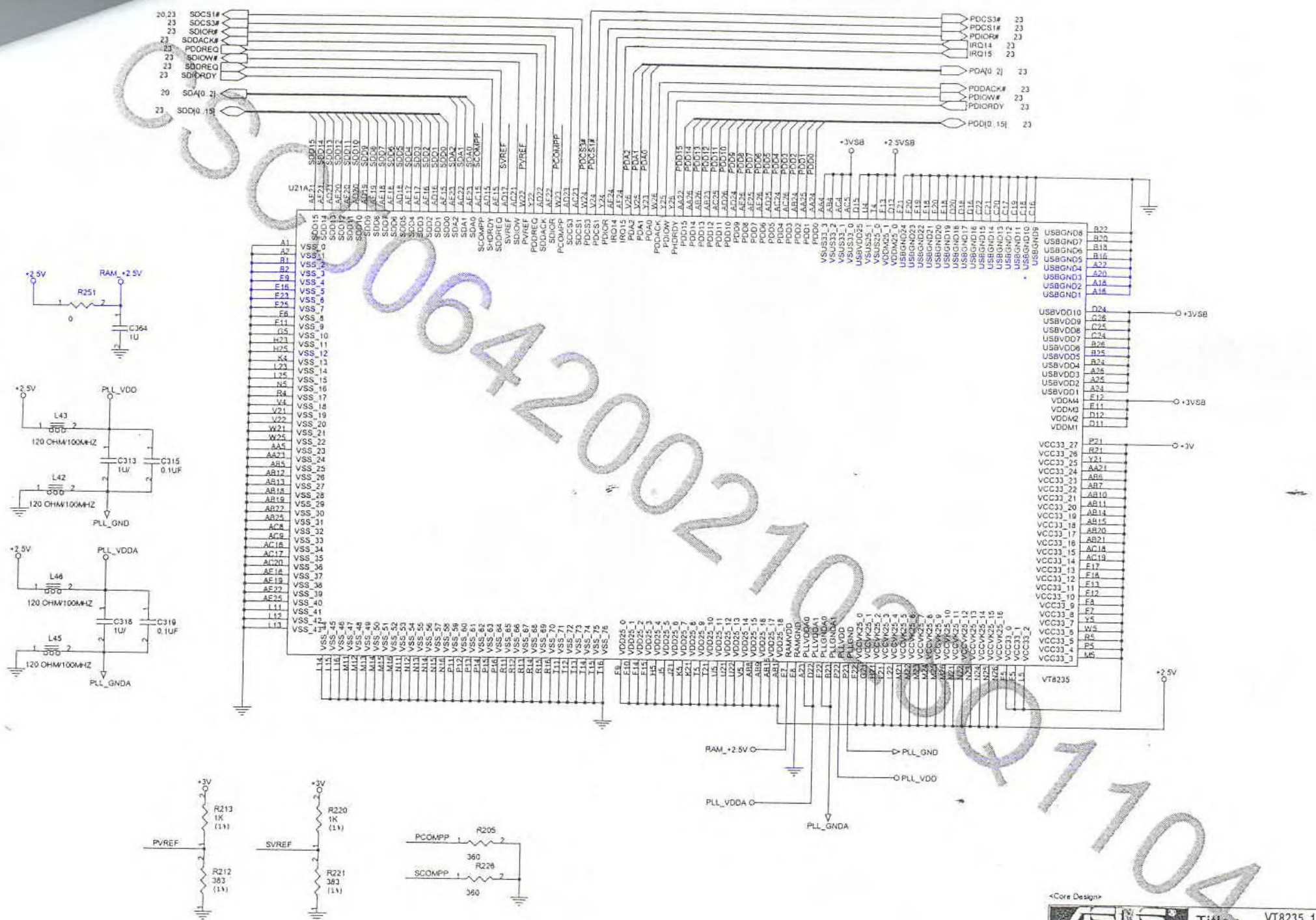

DDR Termination

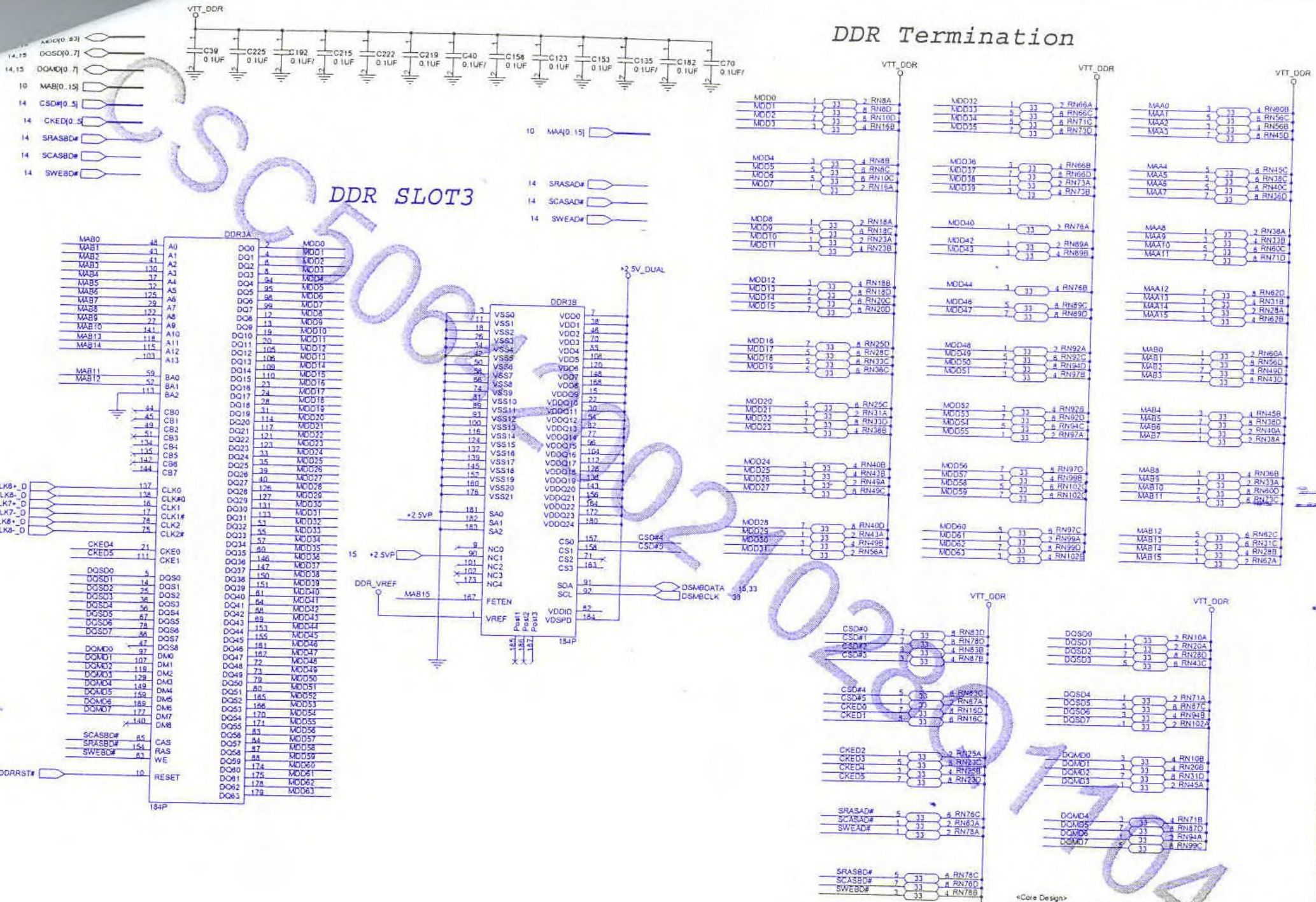

DDR SLOT3

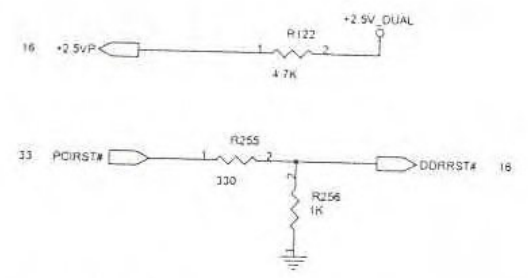
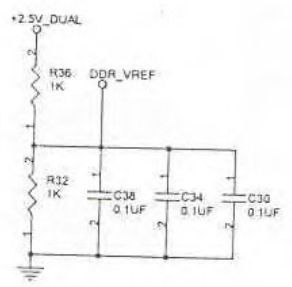
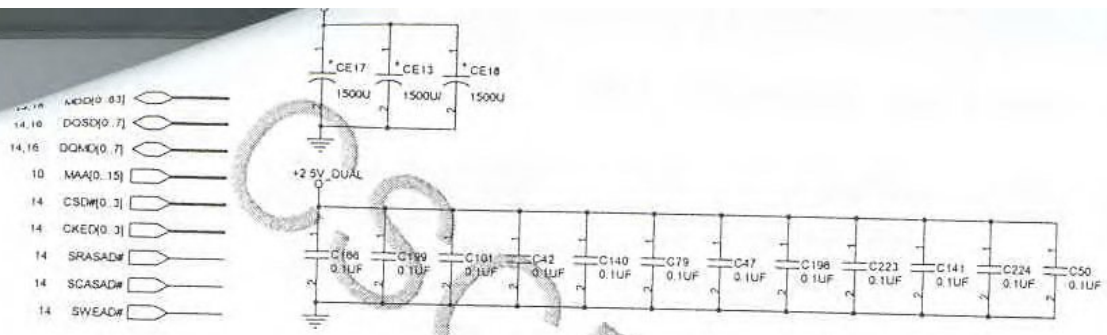

DDR SLOT2

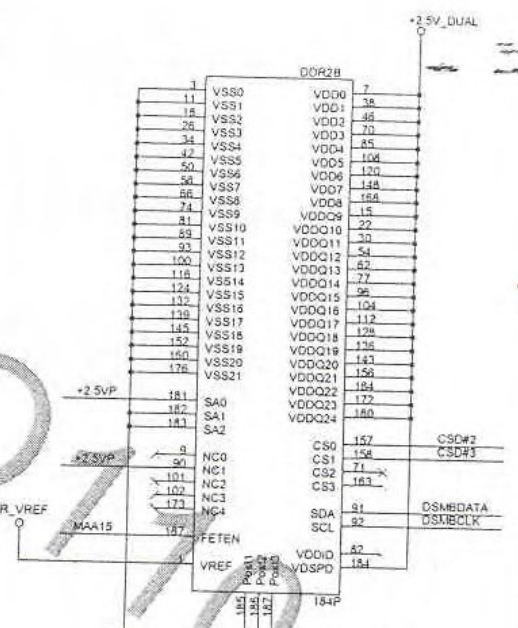
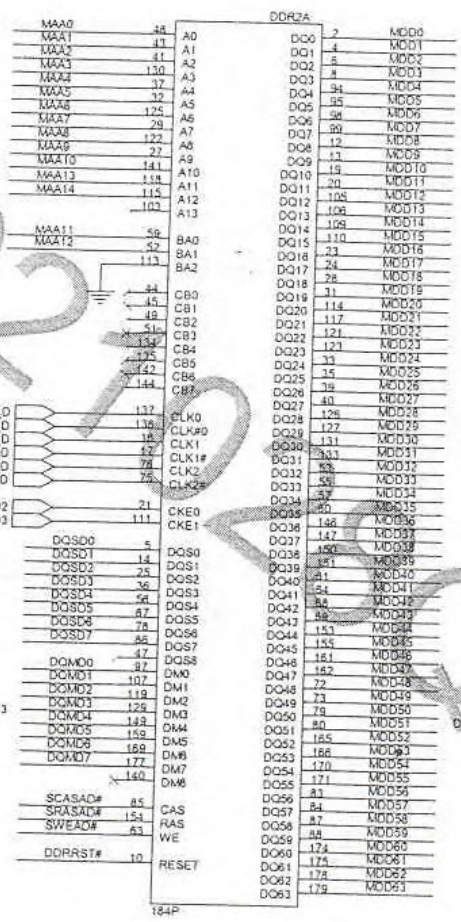
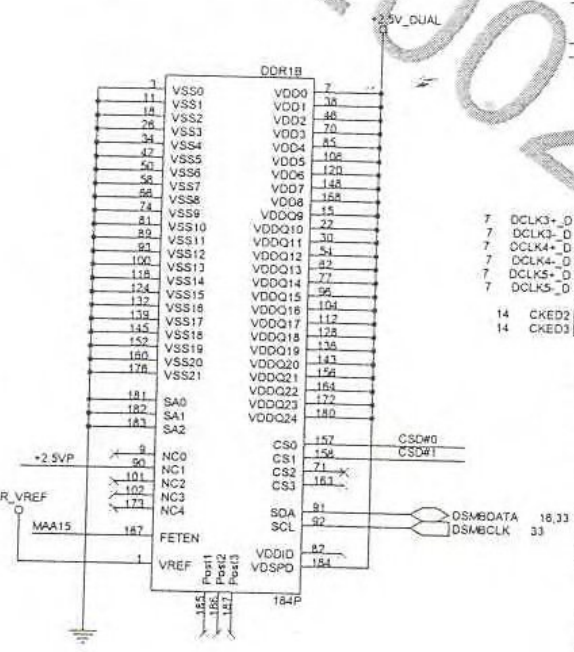
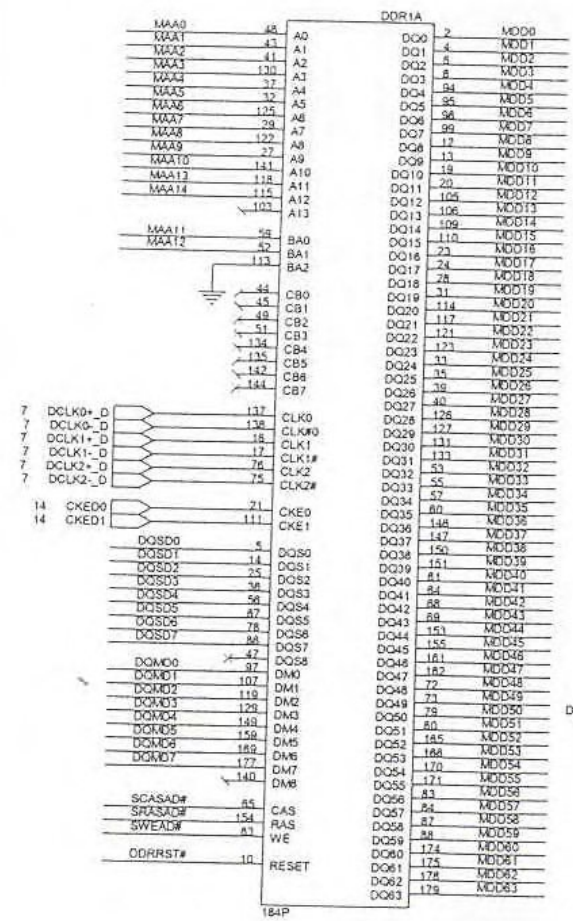

DDR Damping Resistor

- 10 CS#(0..3)
- 10 DQM(0..7)
- 10 CS#(0..5)
- 10 CKE(0..3)
- 10 SRAS#
- 10 SCAS#
- 10 SWEA#
- 10 SRASB#
- 10 SCASB#
- 10 SWEB#

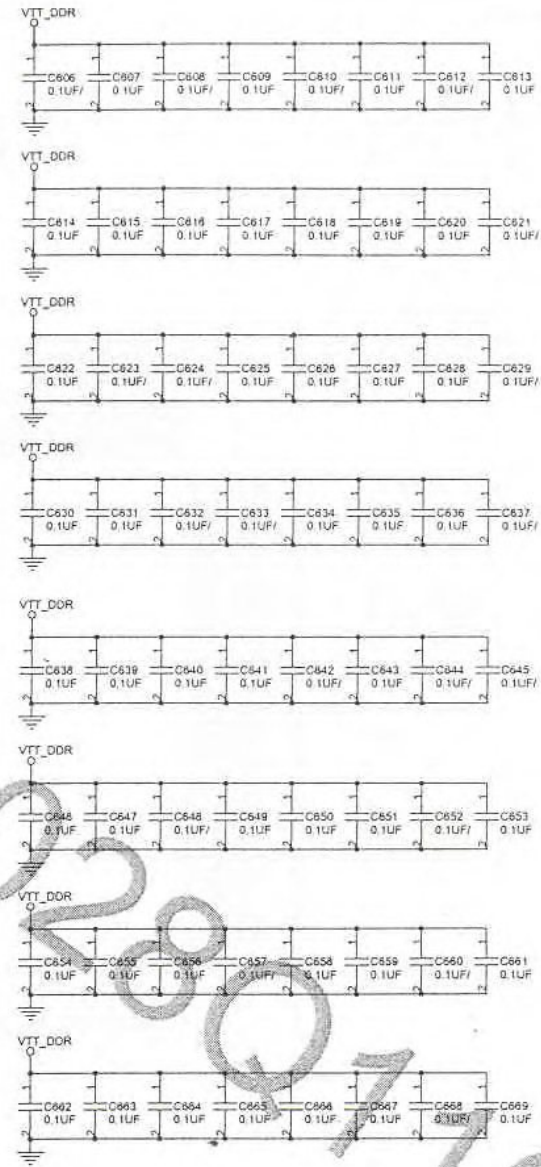
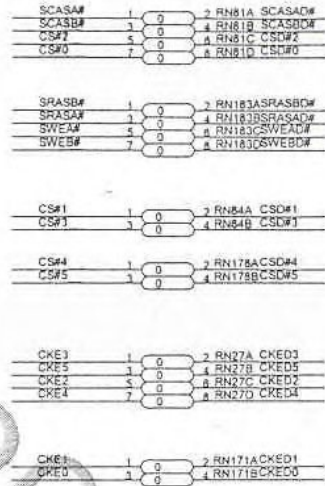
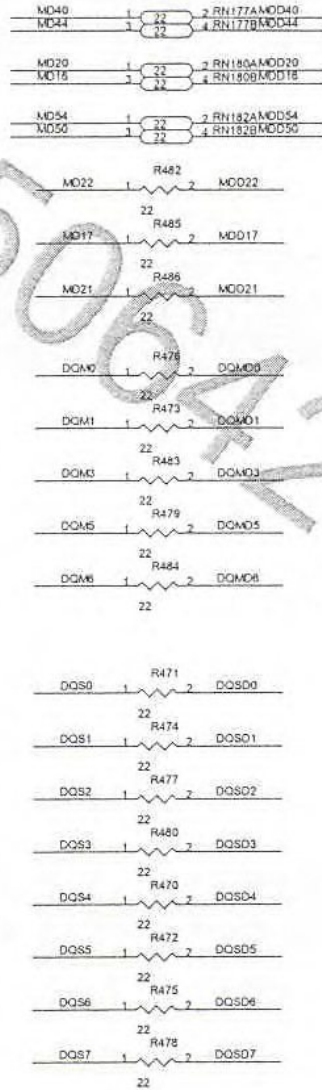
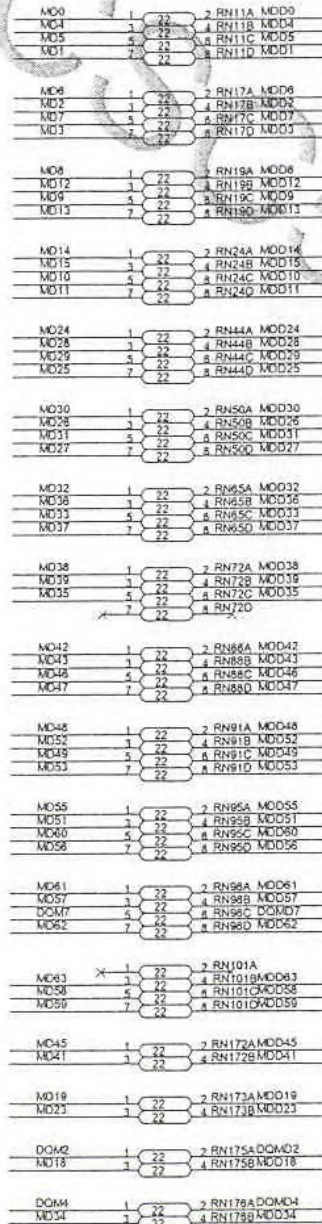

- MOD(0..3) 15,18
- DQSD(0..7) 15,16
- DQMD(0..7) 15,16
- CSD#(0..5) 15,16
- CKED(0..5) 15,16
- SRASAD# 15,16
- SCASAD# 15,16
- SWEAD# 15,16
- SRASBD# 16
- SCASBD# 16
- SWEB# 16

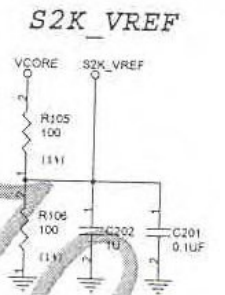
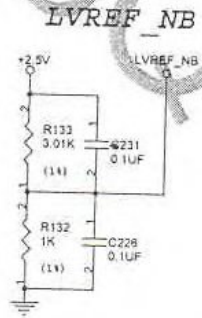
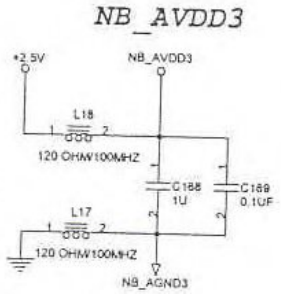
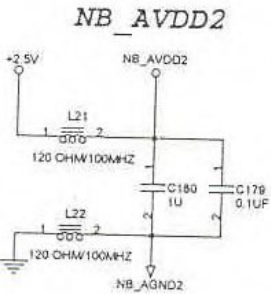
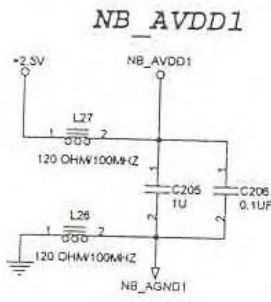
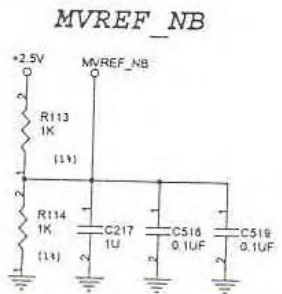
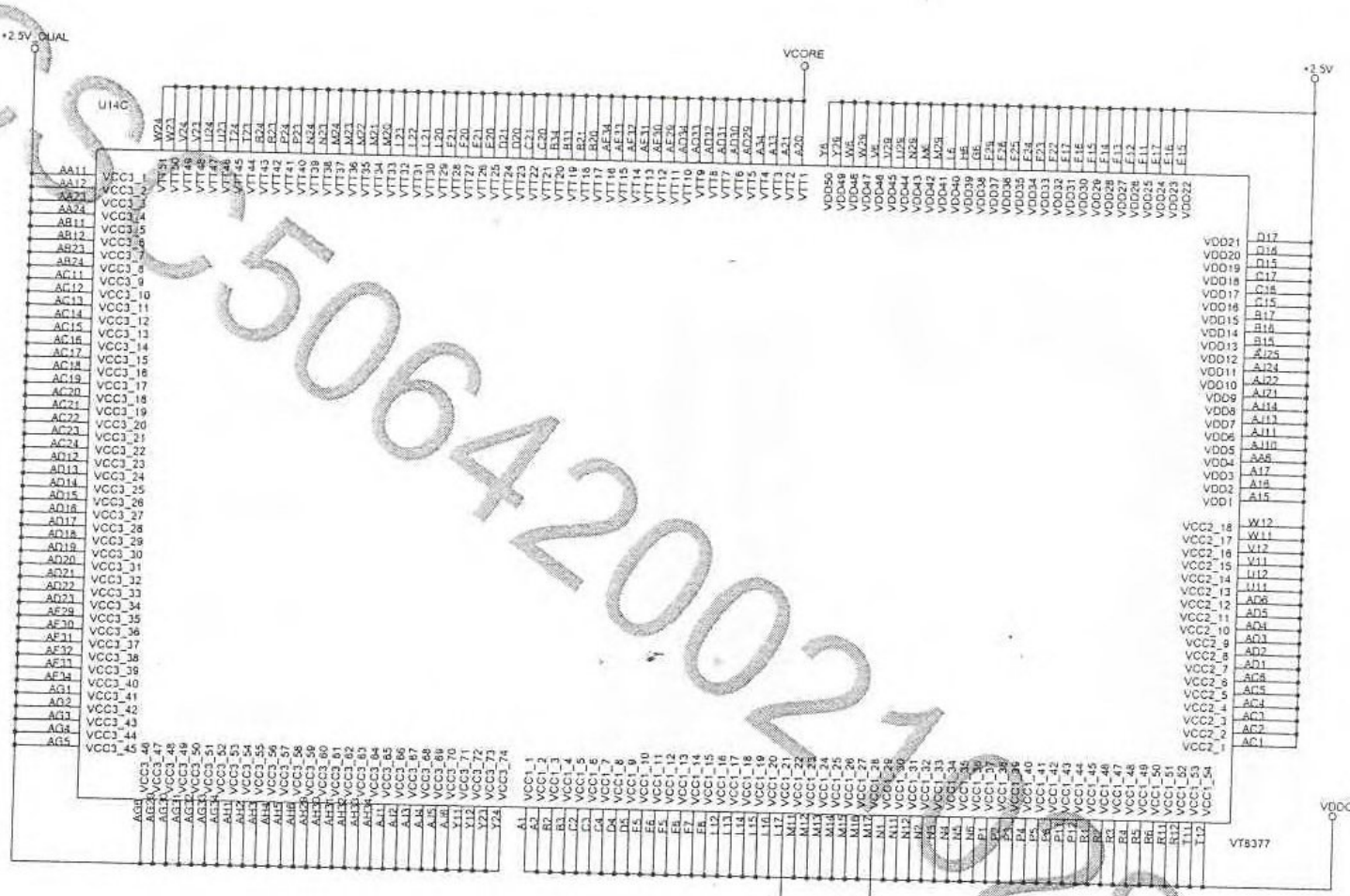

<Core Design>

ASUS		Title	VT8377_3
<OrigName>		Engineer	Lister Chiou
Size	Project Name	A7V8X	Rev
A3			0.1
Date: 2002.11.17		Sheet 12 of 36	

